**User's
Manual**

**DAQSTATION CX1000/CX2000
Communication Interface**

vigilantplant.[®]

Thank you for purchasing the CX1000/CX2000 (CX).

This user's manual contains useful information about the communication function (Ethernet/serial interface) of the CX. To ensure correct use, please read this manual thoroughly before beginning operation. The following nine manuals are also provided in addition to this manual. Read them along with this manual.

Electronic Manuals Provided on the Accompanying CD-ROM

Manual Title	Manual No.	Description
CX1000 User's Manual	IM 04L31A01-03E	Explains all the functions and procedures of the CX1000 (excluding the communication functions).
CX2000 User's Manual	IM 04L31A01-01E	Explains all the functions and procedures of the CX2000 (excluding the communication functions).
DAQSTANDARD for CX User's Manual	IM 04L31A01-61E	Describes the functions and operating procedure of the software "DAQSTANDARD for CX" that comes with the package.

Paper Manuals

Manual Title	Manual No.	Description
CX1000 Operation Guide	IM 04L31A01-04E	Describes concisely the control-related operations of the CX1000. A list of settings is also provided.
CX2000 Operation Guide	IM 04L31A01-02E	Describes concisely the control-related operations of the CX2000. A list of settings is also provided.
CX1000 Installation and Connection Guide	IM 04L31A01-73E	Describes concisely the installation procedures and wiring procedures of the CX1000.
CX2000 Installation and Connection Guide	IM 04L31A01-71E	Describes concisely the installation procedures and wiring procedures of the CX2000.
Precautions on the Use of the CX1000/CX2000	IM 04L31A01-72E	Precautions regarding the use of the CX1000/CX2000. The same information is written on pages iii and iv of this user's manual.
CX1000/CX2000 Control of Pollution Caused by the Product	IM 04L31A01-91C	Gives a description of pollution control.

Notes

- This manual describes the CX of style number "S3."
- The contents of this manual are subject to change without prior notice as a result of continuing improvements to the instrument's performance and functions.
- Every effort has been made in the preparation of this manual to ensure the accuracy of its contents. However, should you have any questions or find any errors, please contact your nearest YOKOGAWA dealer as listed on the back cover of this manual.
- Copying or reproducing all or any part of the contents of this manual without the permission of Yokogawa Electric Corporation is strictly prohibited.
- The TCP/IP software of this product and the document concerning the TCP/IP software have been developed/created by YOKOGAWA based on the BSD Networking Software, Release 1 that has been licensed from California University.

Trademarks

- vigilantplant, DAQSTATION, and Daqstation are registered trademarks of Yokogawa Electric Corporation.
- Microsoft and Windows are registered trademarks or trademarks of Microsoft Corporation in the United States and/or other countries.
- Adobe and Acrobat are registered trademarks or trademarks of Adobe Systems incorporated.
- Company and product names that appear in this manual are registered trademarks or trademarks of their respective holders.
- The company and product names used in this manual are not accompanied by the registered trademark or trademark symbols (® and ™).

Revisions

1st Edition	December 2001
2nd Edition	March 2002
3rd Edition	April 2002
4th Edition	June 2003
5th Edition	May 2007

Safety Precautions

About This Manual

- Please pass this manual to the end user.
- Read this manual thoroughly and have a clear understanding of the product before operation.
- This manual explains the functions of the product. It does not guarantee that the product will suit a particular purpose of the user.
- Under absolutely no circumstances may the contents of this manual be transcribed or copied, in part or in whole, without permission.
- The contents of this manual are subject to change without prior notice.
- Every effort has been made in the preparation of this manual to ensure the accuracy of its contents. However, should you have any questions or find any errors or omissions, please contact your nearest YOKOGAWA dealer.

Precautions Related to the Protection, Safety, and Alteration of the Product

- The following safety symbols are used on the product and in this manual.



“Handle with care.” (To avoid injury, death of personnel or damage to the instrument, the operator must refer to the explanation in the manual.)



Functional ground terminal (Do not use this terminal as a protective ground terminal.)



Protective grounding terminal



Alternating current

- For the protection and safe use of the product and the system controlled by it, be sure to follow the instructions and precautions on safety that are stated in this manual whenever you handle the product. Take special note that if you handle the product in a manner that violate these instructions, the protection functionality of the product may be damaged or impaired. In such cases, YOKOGAWA does not guarantee the quality, performance, function, and safety of product.
- When installing protection and/or safety circuits such as lightning protection devices and equipment for the product and control system or designing or installing separate protection and/or safety circuits for fool-proof design and fail-safe design of the processes and lines that use the product and the control system, the user should implement these using additional devices and equipment.
- If you are replacing parts or consumable items of the product, make sure to use parts specified by YOKOGAWA.
- This product is not designed or manufactured to be used in critical applications that directly affect or threaten human lives. Such applications include nuclear power equipment, devices using radioactivity, railway facilities, aviation equipment, air navigation facilities, aviation facilities, and medical equipment. If so used, it is the user's responsibility to include in the system additional equipment and devices that ensure personnel safety.
- Do not modify this product.

WARNING

Power Supply

Ensure that the source voltage matches the voltage of the power supply before turning ON the power.

Protective Grounding

Make sure to connect the protective grounding to prevent electric shock before turning ON the power.

Necessity of Protective Grounding

Never cut off the internal or external protective earth wire or disconnect the wiring of the protective earth terminal. Doing so invalidates the protective functions of the instrument and poses a potential shock hazard.

Defect of Protective Grounding

Do not operate the instrument if the protective earth or fuse might be defective. Make sure to check them before operation.

Do Not Operate in an Explosive Atmosphere

Do not operate the instrument in the presence of flammable liquids or vapors. Operation in such environments constitutes a safety hazard.

Do Not Remove Covers

The cover should be removed by YOKOGAWA's qualified personnel only. Opening the cover is dangerous, because some areas inside the instrument have high voltages.

External Connection

Connect the protective grounding before connecting to the item under measurement or to an external control unit.

Damage to the Protective Structure

Operating the CX in a manner not described in this manual may damage its protective structure.

Exemption from Responsibility

- YOKOGAWA makes no warranties regarding the product except those stated in the WARRANTY that is provided separately.
- YOKOGAWA assumes no liability to any party for any loss or damage, direct or indirect, caused by the user or any unpredictable defect of the product.

Handling Precautions of the Software

- YOKOGAWA makes no warranties regarding the software accompanying this product except those stated in the WARRANTY that is provided separately.
- Use the software on a single PC.
- You must purchase another copy of the software, if you are to use the software on another PC.
- Copying the software for any purposes other than backup is strictly prohibited.
- Please store the original media containing the software in a safe place.
- Reverse engineering, such as decompiling of the software, is strictly prohibited.
- No portion of the software supplied by YOKOGAWA may be transferred, exchanged, or sublet or leased for use by any third party without prior permission by YOKOGAWA.

How to Use This Manual

Structure of the Manual

This user's manual consists of the following sections.

Chapter 1 Functional Explanation

Describes the relationship between the communication functions and the interface and gives an overview of the communication functions.

Chapter 2 Ethernet Interface

Describes the specifications and setup procedures of the Ethernet interface. Describes the FTP client function, Web server function, and e-mail transmission function. Also describes how to display the log screen.

Chapter 3 Serial Interface

Describes the specifications and setup procedures of the serial interface. There are two types of serial interfaces: RS-232 and RS-422/485.

Chapter 4 Modbus Protocol

Describes the specifications and setup procedures of the Modbus protocol and the status indication screen of the Modbus master.

Chapter 5 Ladder Communication Protocol

Describes the specifications, the setup procedures, and program samples of the ladder communication protocol.

Chapter 6 Commands

Describes each command that is available.

Chapter 7 Responses

Describes the panel setup information that the CX outputs and the measured/computed/control data formats.

Chapter 8 Status Reports

Describes the status information.

Chapter 9 Green Series Communications

Describes the setup procedures of the Green series communication function.

Appendix

Provides an ASCII character code table, setup flow charts for outputting data from the CX, and a list of messages.

Index

Index of contents.

Conventions Used in This Manual

Unit

- k: Denotes “1000.” Example: 5 kg, 100 kHz
- K: Denotes “1024.” Example: 640 KB (storage capacity of floppy disks)

Symbols

The following symbols are used in this manual.



A symbol affixed to the instrument. Indicates danger to personnel or instrument and the operator must refer to the user’s manual. The symbol is used in the User’s Manual to indicate the reference.

WARNING

Calls attention to actions or conditions that could cause serious injury or death to the user, and precautions that can be taken to prevent such occurrences.

CAUTION

Describes precautions that should be observed to prevent minor or moderate injury, or damage to the instrument.

Note

Provides important information for the proper operation of the instrument.

Displayed Characters

Alphanumeric characters enclosed by brackets are mainly characters and numbers that appear on the display.

Symbols Used on Pages Describing Operating Procedures

On pages that describe the operating procedures in chapters 2 through 9, the following symbols are used to distinguish the procedures from their explanations.

Explanation

This section describes the setup parameters and the limitations regarding the procedures.

Procedure

Carry out the procedure according to the step numbers. The procedures are given with the premise that the user is carrying out the steps for the first time. Depending on the operation, not all steps need to be taken.

Names and Uses of Parts and Setup Procedures Using the Operation Keys

Front Panel

CX1000

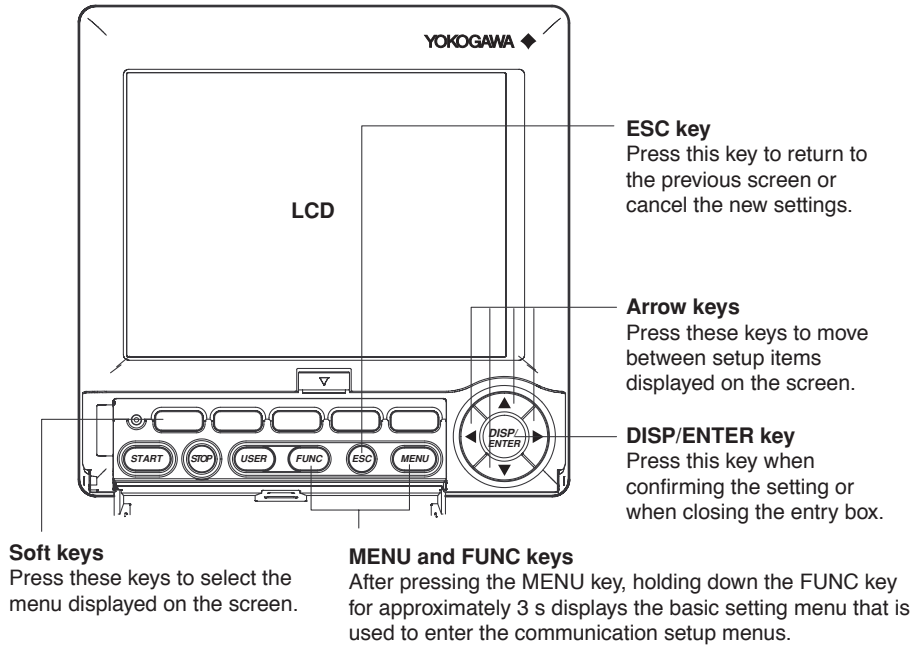

CX2000

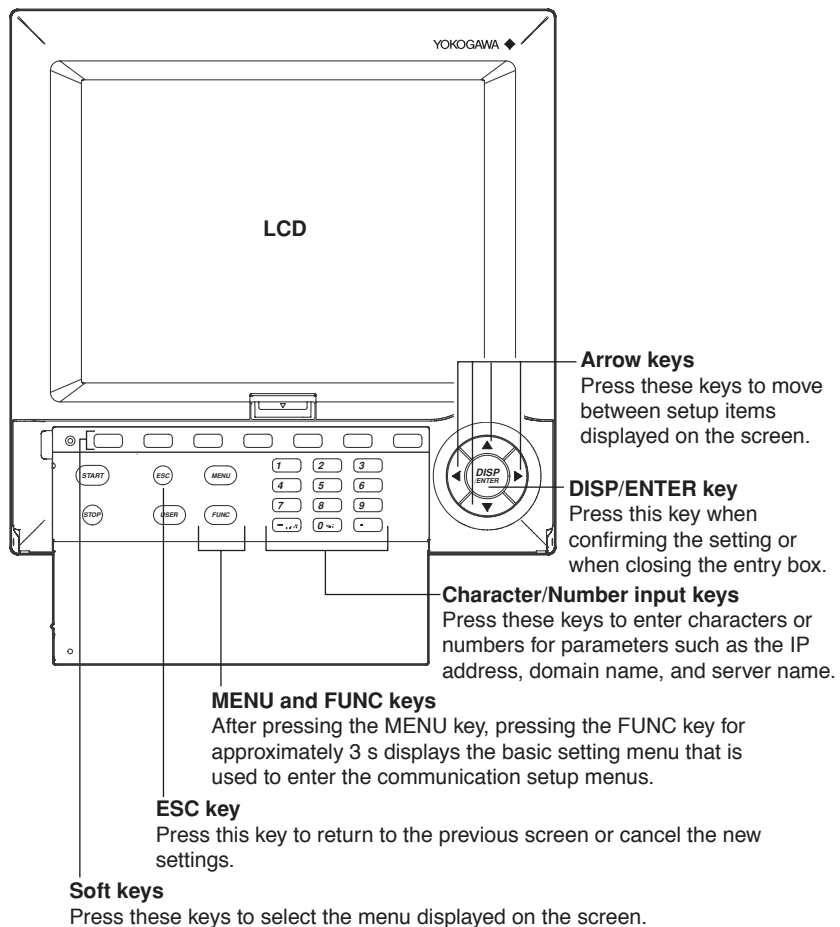

Rear Panel

CX1000

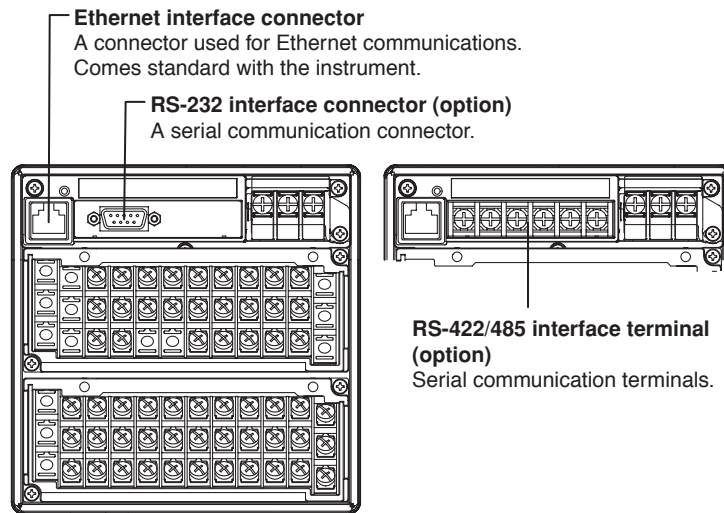

CX2000

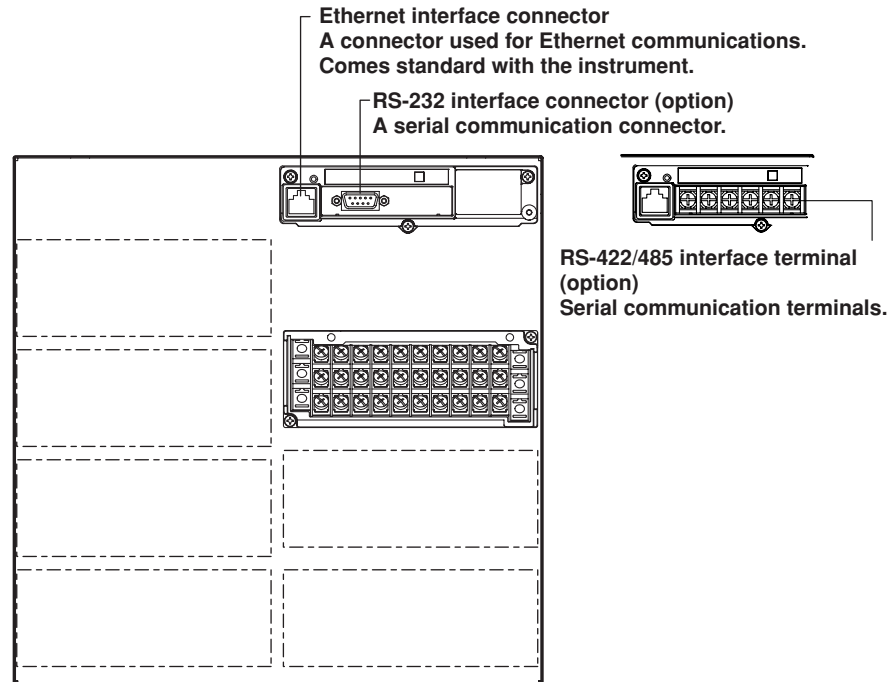

Setup Procedure Using Operation Keys

Below is the basic flow of operations when changing the settings of the CX2000 using the front panel keys.

Settings related to communications are configured in the basic setting mode. The procedure used to enter the basic setting mode is described in the procedures for each item. Basic setting mode cannot be entered while control operation, data acquisition, or computation using the computation function (/M1 option) is in progress.

1. Press the [#7] (Option) soft key. The communication function setup menu appears.
2. Press the [#1] (Ethernet, Serial) soft key. The communication (Ethernet, Serial) setting display appears.
3. Press the arrow keys to move the cursor to the setup item.



4. For setup items that display possible choices at the bottom of the display, press the soft key below the choice. For setup items that require characters to be entered in an entry box (numeric value input pop-up window), press the [Input] soft key, enter the appropriate characters in the entry box, and press the DISP/ENTER key.

Parameter selections
(Selection example for [DNS On/Off].
Press either the [On] or [Off] soft key.)

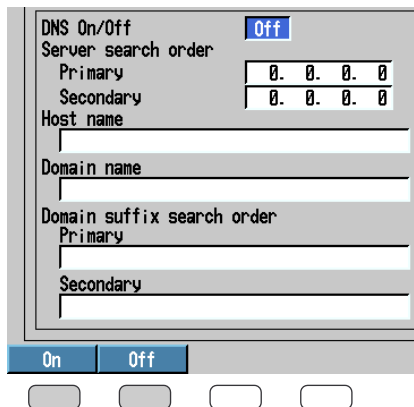

Parameter entry box
(Example of the entry box for the IP address)

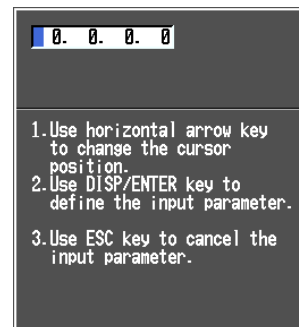

- The setup item boxes that have not been changed remain white.
- The setup item boxes that have been changed turn yellow.

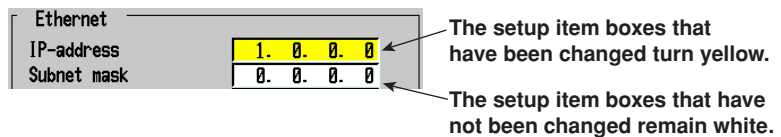

5. Set other setup items according to steps 3 and 4.

Names and Uses of Parts and Setup Procedures Using the Operation Keys

6. The operation varies depending on whether you wish to confirm or cancel the changed settings (those setup item boxes that are yellow) as follows.
- When confirming the changes
Press the DISP/ENTER key. The settings that were changed are confirmed, and the yellow setup boxes turn white. At the same time, the cursor moves to the setup item at the upper left corner of the display (the first setup item on the display). However, if the new settings violate the rules for the corresponding items, the setup item box turns red.

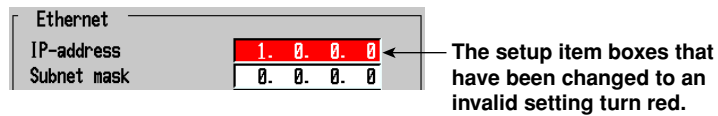

- When canceling the changes
Press the ESC key. A confirmation dialog box appears.
Select [Yes] and press the DISP/ENTER key to cancel the setting changes and return to the previous display.
Select [No] and press the DISP/ENTER key to abort the cancellation and return to the display that you were working on.

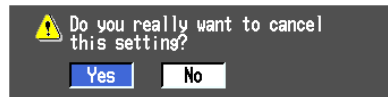

7. To activate the settings that have been changed in the basic setting mode, the settings must be saved. Press the [End] soft key on the basic setting menu.* A confirmation dialog box appears.
- To save the settings, select [Yes]. To not save the settings, select [No]. To return to the basic setting menu, select [Cancel]. Then, press the DISP/ENTER key.
- * The basic setting menu is the menu that appears when the ESC key is pressed several times after entering the basic setting items.

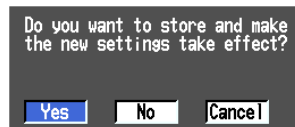

Contents

	Safety Precautions	iii
	How to Use This Manual	v
	Names and Uses of Parts and Setup Procedures Using the Operation Keys	vii
Chapter 1	Functional Explanation	
1.1	Overview of the Communication Functions	1-1
1.2	Ethernet Communication Function	1-2
	E-mail Transmission	1-2
	Web Server	1-3
	FTP Client	1-4
	FTP Server	1-5
	Setting/Measurement Server	1-6
	Maintenance/Test Server	1-6
	Instrument Information Server	1-6
	DAQSTANDARD for CX	1-7
	Other Functions	1-8
1.3	Serial Communication Function	1-9
	Green Series Communications	1-9
	Modbus Master	1-10
	Modbus Slave	1-11
	Ladder Communications	1-12
	Communication with PCs	1-13
Chapter 2	Ethernet Interface	
2.1	Ethernet Interface Specifications	2-1
	Basic Specifications	2-1
	Maximum Number of Simultaneous Connections/Number of Simultaneous Users	2-1
2.2	Connecting of the Ethernet Interface	2-2
	When Connecting Only the CX and Your PC	2-2
	When Connecting to a Preexisting Network	2-2
2.3	Configuring of the Ethernet Interface	2-3
2.4	Checking the Ethernet Interface Connection	2-9
	Checking the Connection on the Rear Panel of the CX	2-9
	Checking the Connection on the CX Display	2-9
2.5	Setting the FTP Client (Setting the Automatic Transfer of Display, Event, and Report Data Files)	2-10
2.6	FTP Test	2-16
2.7	Setting the Login and Timeout Functions of Ethernet Communications	2-17
2.8	Displaying the Error, Communication, and FTP Log Screens	2-22
2.9	Setting the Web Server Function	2-26
2.10	Using the Monitor Page and Operator Page	2-31
	Using the Monitor Page	2-35
	Using the Operator Page	2-36
2.11	Setting the E-mail Transmission Function	2-38
2.12	E-mail Transmission Test	2-47
2.13	Starting/Stopping E-mail Transmissions	2-48
2.14	Processing during Recovery of the DO/Internal Switch Communication Buffer	2-50

Chapter 3 Serial Interface

3.1	Serial Interface Specifications	3-1
	RS-232 Specifications	3-1
	RS-422/485 Specifications	3-1
3.2	Connector Pin Arrangement and Signal Names, Connection Procedure, and Handshaking Methods of the RS-232 Interface	3-2
	Connector Pin Arrangement and Signal Names	3-2
	Connection Procedure	3-2
	Handshaking	3-3
3.3	Terminal Arrangement and Signal Names and the Connection Procedure of the RS-422/485 Interface	3-5
	Terminal Arrangement and Signal Names	3-5
	Connection Procedure	3-5
	Connection Example with the Other Instruments	3-6
3.4	The Bit Structure of One Character and the Operation of the Receive Buffer	3-9
	The Bit Structure of One Character	3-9
	Receive Buffer and Received Data	3-9
3.5	Configuring the Serial Interface	3-10
3.6	Automatic Recovery Settings	3-14

Chapter 4 Modbus Protocol

4.1	Modbus Protocol Specifications	4-1
4.2	Configuring the Modbus Protocol	4-2
4.3	Setting the Modbus Master Function	4-5
4.4	Checking the Operation Status of the Modbus Master Function	4-11
4.5	Communications as a Modbus Slave	4-13
	Command Message Construction	4-13
	Specifying the Register Number	4-13
	Broadcast Request	4-14
	Function Code	4-14
4.6	Modbus Slave Error Responses	4-16
	Message Format for Errors	4-16
	Response Error Codes	4-16
	When Responses Are Not Received	4-16

Chapter 5 Ladder Communication Protocol

5.1	Ladder Communication Protocol Specifications	5-1
5.2	Setting the Ladder Communication Protocol	5-2
5.3	Communications with PLCs	5-5
	Command Construction	5-5
	Response	5-6
	Response When Errors Occur	5-7
5.4	Communication Program for FA-M3	5-8
5.5	Communication Program for MELSEC	5-13
	Preparations before Communications	5-13

Chapter 6 Command

6.1	Command Syntax	6-1
	Command Syntax	6-1
	Response	6-3
6.2	A List of Commands	6-4
	Setting Commands (Control)	6-4
	Setting Commands (Measurement)	6-6
	Basic Setting Commands (Measurement)	6-8
	Basic Setting Commands (Control)	6-9
	Control Commands	6-10
	Output Commands (Measurement)	6-10
	Output Commands (Control)	6-11
	Maintenance/Test Commands (Available when using the maintenance/test server function via Ethernet communications)	6-12
	Instrument Information Output Commands (Available when using the instrument information server function via Ethernet communications)	6-12
6.3	Input Range Parameter	6-13
6.4	Setting Commands (Control)	6-15
	Control Input Range	6-15
	Control Alarm	6-17
	Operation-related Parameters	6-17
	PID Parameters	6-18
	Control Group Setting	6-19
	Ten-segment Linearizer Input/Output	6-20
	Pattern Initial Setting	6-20
	Wait Action Setting	6-21
	Program Initial Setting	6-21
	Program Operation Parameters	6-21
	Event Setting	6-21
	Event Output Setting	6-22
	Repeat Action Setting	6-22
	Program End	6-22
	Auto message for program Run/Reset	6-22
	Program display position	6-22
	Auto change to program run display	6-22
	Event Display Group	6-22
	Detail Settings (Control Function Settings)	6-23
	Detail Settings (Hysteresis (Alarm, PV Event))	6-23
	Detailed Settings (DIO Operation Monitoring Function Settings)	6-23
	Detailed Settings (DI/DO Label Settings)	6-25
	Control Computation	6-25
	External Loop PID Parameter Settings	6-26
	External Loop Control Parameter Settings	6-26
6.5	Setting Commands (Measurement)	6-27
6.6	Setting Commands (Operation)	6-36
6.7	Basic Setting Commands (Measurement)	6-40

1

2

3

4

5

6

7

8

9

App

Index

Contents

6.8	Basic Setting Commands (Control)	6-49
	Control Action, Input Setting	6-49
	Contact Input Registration/AUX	6-50
	Output Processing	6-51
	Relay	6-51
	Tuning Setting	6-52
	External Loop Setting (Basic Setting)	6-52
	External Loop Setting (Parameter Address Setting)	6-53
6.9	Control Commands	6-54
	Control Commands	6-54
6.10	Output Commands (Measurement-Control)	6-55
6.11	Output Commands (Measurement-Setup, Measurement, and Computation Data Output)	6-55
6.12	Output Commands (Measurement-RS-422/485 Dedicated Commands)	6-59
6.13	Output Commands (Control)	6-59
6.14	Maintenance/Test Commands (Available when using the maintenance/test server function via Ethernet communications)	6-61
6.15	Instrument Information Output Commands (Available when using the instrument information server function via Ethernet communications)	6-63

Chapter 7 Response

7.1	Response Syntax	7-1
	Affirmative Response	7-1
	Single Negative Response	7-1
	Multiple Negative Responses	7-1
	ASCII Output	7-2
	BINARY Output	7-2
	RS-422/485 Dedicated Commands and Responses	7-5
7.2	Output Format of ASCII Data	7-6
	Setting Data/Basic Setting Data	7-7
	Decimal Point Position/Unit Information	7-8
	Measured/Computed/Control Data	7-9
	SP Number and PID Number	7-10
	Control Mode Output	7-11
	Program Operatin Mode Output	7-12
	Output of Program Pattern Information Currently in Execution	7-12
	Output of PV Event/Time Event Information	7-14
	Status of the Program Control End Signal	7-15
	Communication Log	7-15
	FTP Log	7-17
	Operation Error Log	7-18
	Key Login Log	7-18
	Web Operation Log	7-19
	E-mail Log	7-20
	Alarm Summary	7-21
	Message Summary	7-22
	Status Information	7-22
	File List	7-23
	Data List	7-24
	User Level	7-25

7.3	Output Format of BINARY Data	7-26
	Measured/Computed/Control Data and FIFO Data	7-26
	Display Data	7-28
	Event Data	7-30
	Manual Sampled Data	7-30
	Report Data (Hourly, Daily, Weekly, and Monthly)	7-30
	DI/DO Data and Internal Switch Status (Style Number S3 Or Later)	7-31
	Status (Active/Inactive) of DIO Operation Monitoring Function Operation Mode (Style Number 3 or Later)	7-32
	Number and Operation Status of the Currently Running Program Patterns (Style Number 3 or Later)	7-35
	Measurement/Computation/Control Channel Alarm Types, Output of Settings (Style Number S3 or Later)	7-36
	Output of Upper/Lower Limit of Input Span and Decimal Point Position for Measurement/Computation/Control Channels (Style number S3 or later)	7-37
7.4	Output Format of Instrument Information	7-39
	Response	7-39
	Output Example	7-39

Chapter 8 Status Reports

8.1	Status Information and Filter	8-1
8.2	Bit Structure of the Status Information	8-2
	Status Information 1	8-2
	Status Information 2	8-2
	Status Information 3	8-2
	Status Information 4	8-2

Chapter 9 Green Series Communications

9.1	Specifications of the Green Series Communication Function	9-1
9.2	Setup Procedure of the Green Series Communication Function	9-4
9.3	Setting the Modbus Master	9-5
9.4	External Loop Setting > Basic Setting	9-6
9.5	External Loop Setting > Parameter Address Setting	9-14
9.6	External Loop Setting > Tuning Setting	9-17
9.7	Checking the Operating Conditions of the Green Series Communication Function	9-22
9.8	Starting the Operation	9-24
9.9	Operations That You Can Carry Out during Control Operation	9-25

1

2

3

4

5

6

7

8

9

App

Index

Appendix

Appendix 1	ASCII Character Codes	App-1
Appendix 2	Output Flow of Internal Memory Data	App-2
	Display Data Example	App-2
Appendix 3	Output Flow of the File or the File List on the External Storage Medium	App-4
	Example in Which the File 10101000.CDS in the DATA0 Directory Is Output	App-4
	Example in Which the File List Belonging to Directory DATA0 Is Output 10 Files at a Time	App-5
Appendix 4	Output Flow of FIFO Data	App-6
	Overview of the FIFO Buffer	App-6
	Example in Which the FIFO Acquisition Interval on the CX Is Set to 1 s and the Measured/Computed/Control Data from CH1 to CH248 Is Continuously Output using the FIFO Function (Logging)	App-7
Appendix 5	Data Dropout during Modbus Master	App-8
Appendix 6	Register Assignments	App-9
	Register Assignments during Modbus Slave	App-9
	• Hold Registers	App-9
	• Control Channel Bias and Filter Values When PV/SP Computation is ON	App-19
	• Program Control Parameters	App-20
	• Program Individual Control Parameters	App-22
	• Write Registers for DO/internal switches	App-24
	• Input Registers	App-25
	Register Assignments during Ladder Communications	App-29
	• Writable and Readable Parameters	App-29
	• Control Channel Bias and Filter Values When PV/SP Computation is ON	App-39
	• Program Control Parameters	App-40
	• Program Individual Control Parameters	App-42
	• Write Registers for DO/internal switches	App-44
	• Read-only Parameters	App-45
Appendix 7	Messages	App-49
	Errors Related to Parameter Settings	App-49
	• Setting Errors	App-49
	• Execution Errors	App-49
	Operation Errors	App-50
	• Errors Related to the External Storage Medium	App-50
	• Errors Related to E-mail and Web Server	App-50
	• Errors Related to FTP Client	App-51
	Communication Errors	App-54
	• Errors during Setting and Basic Setting Modes, Output Communication Command Execution, and Setup Data Loading	App-54
	• Memory Access Errors during Setting and Basic Setting Modes and Output Communication Command Execution	App-54
	• Maintenance and Test Communication Command Errors	App-54
	• Other Communication Errors	App-55
	• Status Messages	App-55
	• Errors Related to Control Operation	App-55
Appendix 8	Login Procedure	App-56

Index

1.1 Overview of the Communication Functions

The CX comes with the Ethernet Interface as standard. A serial interface (either RS-422/485 or RS-232) can be installed optionally.

The functions that you can use with each interface and the equipment that is used with the function (hardware and software) are as follows.

Ethernet Interface

Function	Protocol	Devices and Software Used on the Network	User Control	Reference Page
E-mail transmission	SMTP	E-mail server and E-mail software	–	Page 1-2
Web server	HTTP	Internet browser	Yes	Page 1-3
FTP client	FTP	FTP server	–	Page 1-4
FTP server	FTP	FTP software	Yes	Page 1-5
Setting/Measurement server	Dedicated protocol	DAQSTANDARD for CX, etc.	Yes	Page 1-6
Maintenance/Test server	Dedicated protocol		Yes	Page 1-6
Instrument information server	UDP		–	Page 1-6

Serial Interface (RS-422/485 or RS-232)

Function	Protocol	Connected Devices	Reference Page
Green series communications	Modbus	UT Series Controllers by Yokogawa M&C Corporation	Page 1-9
Modbus master	Modbus	Modbus slave devices (Green series controllers, power monitors, DARWIN Data Acquisition Equipment Series by YOKOGAWA, etc.)	Page 1-10
Modbus slave	Modbus	Modbus master device (Measurement instruments, PCs, PLCs, etc.)	Page 1-11
Slave station of ladder communications	Ladder communications	PLC	Page 1-12
Setting/Measurement server	Dedicated protocol	PC (DAQSTANDARD for CX, etc.)	Page 1-13
Maintenance/Test server	Dedicated protocol		Page 1-13

1.2 Ethernet Communication Function

The CX comes with an Ethernet interface as standard. The interface can be used to connect to a preexisting network (Internet or Intranet). By connecting to a network, you can fully utilize the network function. Some of the functions include setting of the CX from your PC, remote monitoring using the Web browser, alarm notification using e-mail, and FTP transfer of data files.

To use this function, you must connect to a network and set the Ethernet interface properly. For a description of the settings of the Ethernet interface, see chapter 2.

E-mail Transmission

This function automatically sends e-mail messages notifying you of alarms and errors. E-mail messages containing the following information are sent to a specified e-mail addresses. For recipients, you can set two groups containing registration of multiple e-mail addresses. In addition, the information that is sent to each group can be different.

- **When an alarm is activated/released**
Notifies the alarm information.
- **When recovering from a power failure**
Notifies the time of the power failure and the time of recovery.
- **When memory end is detected**
Notifies the detection of memory end.
- **When an media-related error occurs**
Notifies the error code and message when an error is detected on the external storage medium or when the data cannot be stored due to insufficient free space on the external storage medium.
- **When an error related to the FTP client occurs**
Notifies the error code and message when data transfer fails using the FTP client function.
- **At the specified time**
Notifies that the specified time has arrived. It is used to confirm that the e-mail transmission operation including the network is working properly. You can specify the reference time and the e-mail transmission interval for each recipient group.
- **When a report is created (when the computation function option /M1 is specified)**
Notifies the report results.

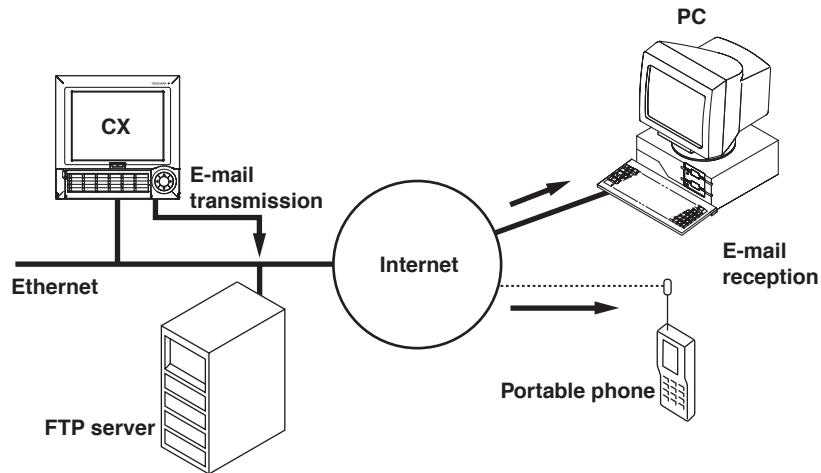
**Note**

- For the procedure in setting the e-mail transmission function, see section 2.11.
- For e-mail transmission examples, see section 2.13.
- For the procedure to start/stop e-mail transmission, see section 2.13.
- You can test to see whether e-mail messages are sent properly. The test results can be confirmed on the e-mail log display. For the procedure of the e-mail transmission test, see section 2.12.

Web Server

You can use a Web browser (Microsoft Internet Explorer) on your PC that is connected to the network to display the CX screen. This function can be used to achieve remote monitoring and monitoring over a wide area. Two types of Web pages can be displayed.

- **Monitor page**
Page dedicated to monitoring.
- **Operator page**
This page allows you to switch the CX displays. You can also modify and write messages.

Note

You can use the CX as a Web server by setting the Ethernet interface (section 2.3) and the Web server function (section 2.9). In addition, you can restrict the access to each Web page by setting the access control (section 2.9).

1.2 Ethernet Communication Function

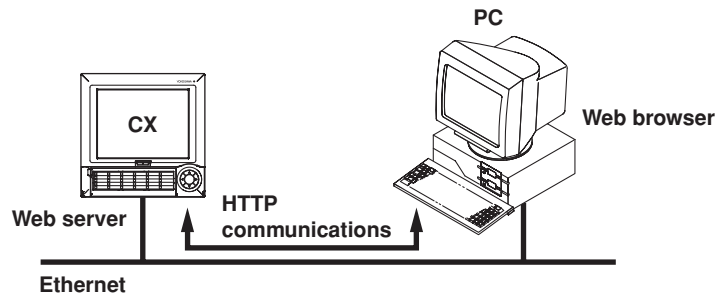

The information that is displayed on the Web browser can be updated manually or automatically.

The displayed information is as follows:

- Alarm summary.
- Values of all channels (measurement, computation, and control channels).
- Various logs (message log, error log, key login/logout log, FTP file transfer log, e-mail log, and Web browser operation log).

Note

- For the procedure in setting the Web server function, see section 2.9.
 - For operations on the monitor page and operator page, see section 2.10.
-

FTP Client

The CX can connect to an FTP server on the network as a client and automatically transfer data files that are stored in the internal memory of the CX. You can specify two destination FTP servers, primary and secondary. By setting the secondary FTP server, the data file can automatically be transferred to the secondary FTP server even if the primary FTP server is down.

Below are the data files that can be transferred.

- Display data file
- Event data file
- Report data file

The result of the data transfer to the FTP server is recorded in the FTP log. You can confirm the FTP log on the CX display or from your PC connected to the CX.

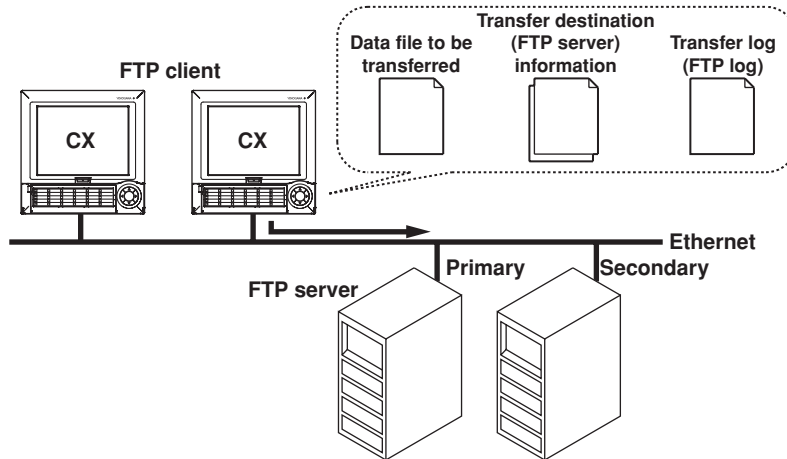
**Note**

- For a description of setting the FTP client function, see sections 2.3 and 2.5.
- You can test to see whether files are sent properly to the FTP server. The test results can be confirmed on the FTP log display. For the operating procedure of the FTP test, see section 2.6.

FTP Server

A PC connected to the network can be used to access the files on the external storage medium that is inserted in the drive on the CX. This is achieved by connecting the PC to the CX via the FTP protocol. You can perform various operations such as copying files on the external storage medium to the hard disk in your PC or delete files on the external storage medium.

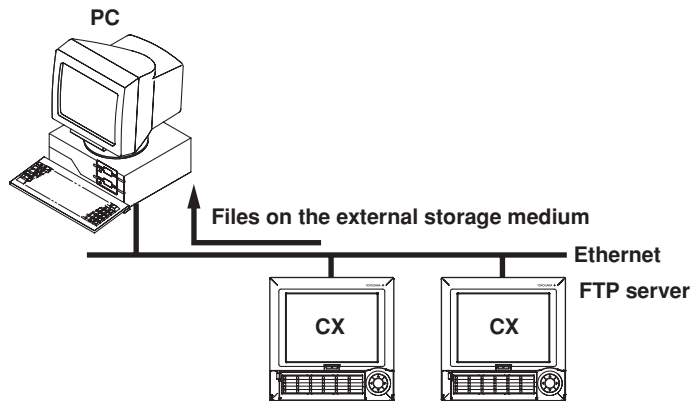
**Note**

The FTP server can be activated by setting the Ethernet interface (section 2.3). You can also restrict the access via FTP by enabling the login function. For the procedure in setting the login function, see section 2.7.

Setting/Measurement Server

The settings on the CX can be changed or the data on the CX can be output to your PC, by sending commands from the PC using programs such as BASIC.

The following types of data can be output using commands.

- Measured, computed, and control data.
- Data in the internal memory.
- Files on the external storage medium.
- Setup information and status byte.
- Operation errors and communication log.

The measured, computed, and control data can be output to a PC in BINARY or ASCII format. Other types of data can be output in ASCII format. For details on the data output format, see chapter 7.

The commands that can be used for this function are, setting commands, basic setting commands, and output commands. For details, see chapter 6.

Note

The setting/measurement server can be activated by setting the Ethernet interface (section 2.3). You can also restrict the access to the setting/measurement server by enabling the login function. For the procedure in setting the login function, see section 2.7.

Maintenance/Test Server

Information such as the connection information of the CX and network statistical information can be retrieved into your PC, by sending commands from the PC using programs such as BASIC.

The commands that can be used for this function are maintenance/test commands. For details, see chapter 6.

Note

The maintenance/test server can be activated by setting the Ethernet interface (section 2.3). You can also restrict the access to the maintenance/test server by enabling the login function. For the procedure in setting the login function, see section 2.7.

Instrument Information Server

Information such as the serial number of the CX and model name can be retrieved into your PC, by sending commands from the PC using programs such as BASIC.

The commands that can be used for this function are instrument information commands. For details, see chapter 6.

Note

The instrument information server can be activated by setting the Ethernet interface (section 2.3).

DAQSTANDARD for CX

By using the DAQSTANDARD for CX, you can easily use the setting/measurement server, maintenance/test server, and instrument information server that are connected via the Ethernet network without having to create programs such as BASIC.

The software enables setting of the CX and displaying of data from a PC connected to the network. Below are the functions provided by the DAQSTANDARD for CX.

- **Hardware Configurator**

The Hardware Configurator can be used to send to the CX various types of data such as settings related to control, settings related to measurement channels and computation channels, and settings related to the display. Conversely, setup data from the CX can be received and stored to the hard disk in your PC.

- **Data Viewer**

The Data Viewer can be used to display the data of files that the CX created on trend displays, digital displays, circular displays, and lists. The data can also be printed. In addition, you can use the cursor to confirm display data values, perform computation over a specified interval, and convert the data into ASCII format or file formats that can be opened using EXCEL/Lotus1-2-3.

- **Program Pattern Editing (This function cannot be used on the current product that you are using. The information may also change in the future.)**

The program control patterns for internal control loops of the CX can be created and edited using a graphical interface.

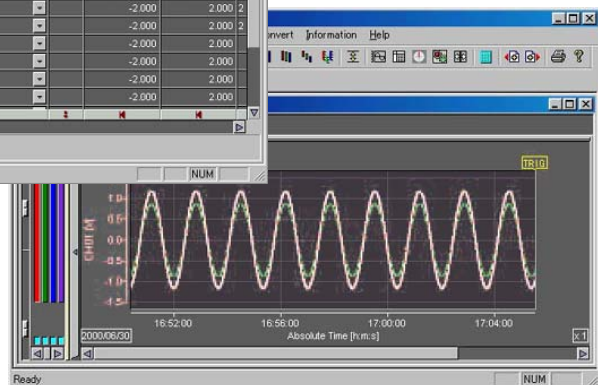
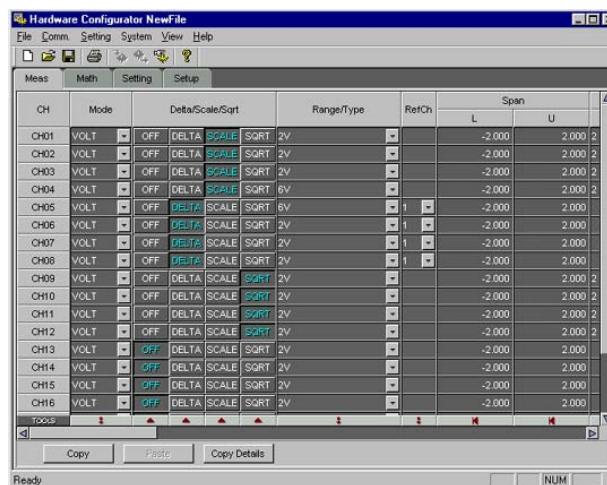

Other Functions

When carrying out communications via the Ethernet interface, the following additional functions can be used.

User Control

User control for connection can be set up to prevent false access to the CX when using the functions of the setting/measurement server, maintenance/test server, and FTP server. User control is performed by registering user names and passwords beforehand and entering the appropriate user name and password at the time of connection.

Up to 7 users can be registered, and access authority are set for each user. There is a limitation on the number of simultaneous connections and simultaneous usage from PCs to the CX. For details, see sections 2.1 and 2.7.

Note

Access authority refers to a function that authorizes specified users for operating the CX. There are two levels of access authority: "ADMINISTRATOR" and "USER." An ADMINISTRATOR is given access authority to use all the functions. Only a single ADMINISTRATOR can be registered. USERS are not given authority to set functions, but can view the data, load files, and so on.

Checking the Condition of the Connection

You can check the physical connection to the Ethernet interface. When connected to the Ethernet network, you can check the connection on the lamp on the rear panel or the indication on the display.

Note

For a description of the location and meaning of the connection status indicator, see section 2.4.

Keep alive (Extension Function of TCP)

Keep alive is a function used to periodically send inspection packets to a PC that is connected to the CX via the network. If a response is not received, this function forcibly disconnects the connection. This function can be used to automatically disconnect users that are connected but are not using the CX and allow connection of new users.

Note

For details on setting the keep alive function, see section 2.7.

Displaying Error, Communication, FTP, Web Operation, and E-mail Log Screens

The CX stores a communication log of the Ethernet interface. The following logs can be shown of the CX display.

- Error log screen: Log of operation errors.
- Communication log screen: Log of communication input/output.
- FTP log screen: Log of file transfers executed using the FTP client.
- Web operation log screen: Log of operations using the Web server function.
- E-mail log screen: Log of e-mail transmissions.

Note

For the procedure of displaying the log screens, see section 2.8.

1.3 Serial Communication Function

If you specified the RS-422/485 or RS-232 serial interface for the communication interface, you can connect various instruments such as PCs, controllers, instruments that support the Modbus (RTU) protocol, and PLCs.

To use this function, the serial interface must be set to match the settings of the connected instrument. Below are settings required in each protocol.

Communication Method	Baud Rate	Data Length	Parity Check	Handshaking	Address
Normal (command communications using dedicated protocol)	Yes	Yes	Yes	Yes	Yes*
Modbus (when the CX is set to master)	Yes	No	Yes	No	No
Modbus (when the CX is set to slave)	Yes	No	Yes	No	Yes
Ladder communications	Yes	No	Yes	No	Yes

Yes: Setting is required. No: Setting is not required.

* Not required in an RS-232 connection.

Note

For details on how to set the serial interface, see chapter 3.

Green Series Communications

By connecting controllers such as UT Series Controllers made by Yokogawa M&C Corporation to the RS-422/485 serial interface of the CX, you can perform operations from the CX such as changing the settings on the controller or retrieving the measured data from the controller and displaying the data on the CX display.

Up to 16 loops (four loops on the CX1000) of controllers can be connected. The process values, target setpoints, and output values of each loop can be shown on the CX display. The log can be stored as a file.

Below are the requirements for connecting controllers to the CX.

- Green series communication option (/CM1) is required on the CX.
- Controllers must have the Modbus (RTU) communication function.
- The controllers must be configured beforehand to perform communications with the CX.
- The serial interface protocol on the CX must be set to Modbus master; the serial interface protocol of the connected controller must be set to Modbus slave.

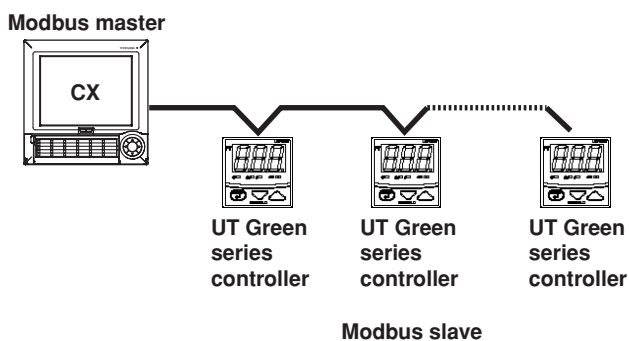

Modbus Master

You can connect other instruments to the CX as Modbus slaves and load measured data and other data. The loaded data can be handled as communication input data of the computation function option (/M1) on the computation channel.

The CX acting as a Modbus master use Modbus commands to periodically retrieve data from the register of Modbus slave devices. The retrieved data is used as communication input data on the CX.

Note

- This function does not support writing of data to other instruments.
 - For details on the Modbus function codes that the CX supports, see section 4.1.
 - For a description of the settings required in using this function, see sections 4.2 and 4.3.
-

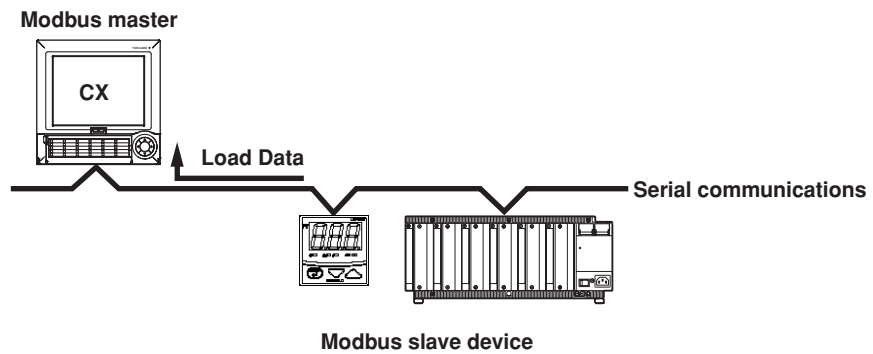

Modbus Slave

The CX can be connected as a Modbus slave device to a Modbus master device. Modbus master devices (PLCs, PCs, etc.) can read and write to the internal register (D register) of the CX.

To perform communications, the Modbus master device always sends a command message to the CX first. A command message from the Modbus master includes information such as the destination Modbus slave address (the address of serial communication settings), the function code (operation command such as read and write), and the register address.

When the CX receives the command message and the message contains no errors, the CX operates according to the instruction and returns a message back to the Modbus master device. If the command message contains errors, an appropriate error code is returned to the Modbus master device.

Note

- The Modbus protocol has two signal transmission modes: RTU mode and ASCII mode. The CX only supports the RTU mode.
- For details on the Modbus function codes that the CX supports, see section 4.5.
- For a description of the settings required in using this function, see section 4.2.

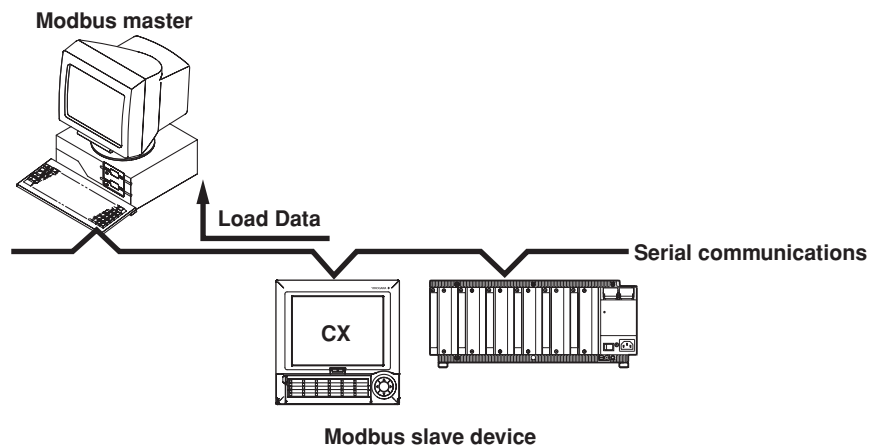

Ladder Communications

You can connect the CX to a host such as a PLC and use the ladder communication protocol to read and write data in the CX register from the host.

In ladder communications, commands from the host are used to send the destination station number (the address of serial communication settings), the D register number, and the write data (setting for control).

To read the measured data on the CX, commands are used to send the destination station number (the address of serial communication settings), the D register number, and the number of data points to be read.

In ladder communications, BCD codes are used to create programs that read and write to the D register.

Note

- The ladder communication function of the CX assumes a connection to a PLC. However, communications with other host machines are possible, if the host machines comply with the ladder communication protocol.
 - In ladder communications, BCD codes are used inside the data frame.
 - For a description of the settings required in using this function, see section 5.1.
-

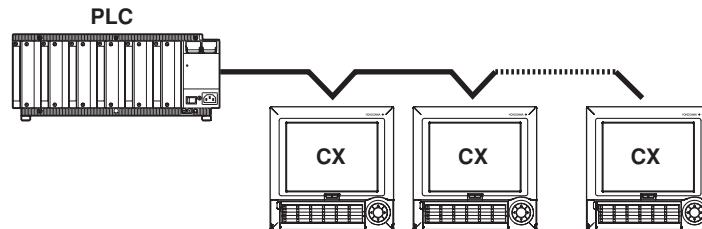

Communication with PCs

When using the setting/measurement server by connecting the CX and a PC, the serial interface protocol is set to “Normal” (command communications using dedicated commands).

The settings on the CX can be changed or the data on the CX can be retrieved into your PC, by sending commands from the PC using programs such as BASIC.

The commands that can be used for this function are, setting commands, basic setting commands, and output commands. For details, see chapter 6.

In addition, the DAQSTANDARD for CX can be used through this connection method. The DAQSTANDARD for CX uses commands that can be used on the setting/measurement server. The graphical user interface of the software enables you to display measured data and make various settings without having to learn commands.

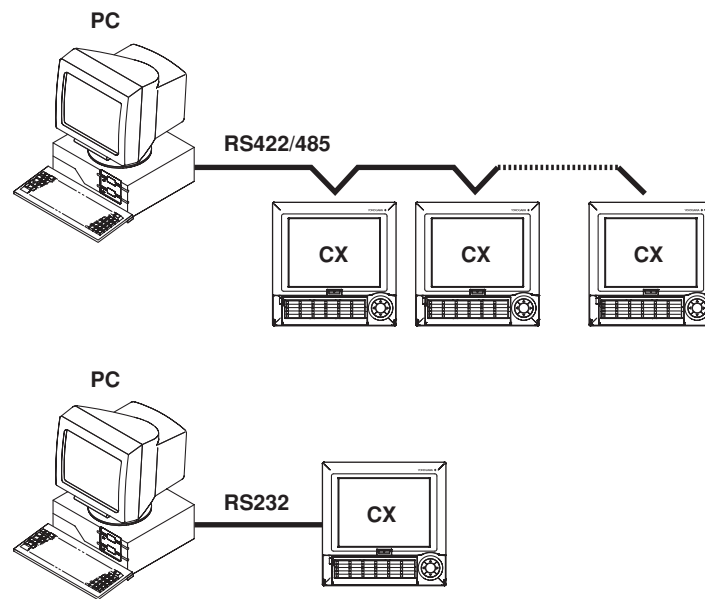

2.1 Ethernet Interface Specifications

Basic Specifications

Electrical and mechanical specifications	Conforms to IEEE 802.3 (Ethernet frames are of DIX specification)
Transmission media	10BASE-T
Protocol	TCP, IP, UDP, ICMP, ARP, SMTP, HTTP1.0, and FTP

Maximum Number of Simultaneous Connections/Number of Simultaneous Users

The following table shows the maximum number of simultaneous connections, the number of simultaneous users, and the port numbers of the CX.

Function	Maximum Number of Simultaneous Connections	Number of Simultaneous Users		Port Number ^{*1}
		ADMINISTRATOR	USER	
Configuration/measurement server	3	1	2 ^{*2}	34260/tcp
Maintenance/test Server	1	1	1 ^{*2}	34261/tcp
FTP server	2	2	2 ^{*2}	21/tcp
Instrument Information Server	–	–	–	34264/udp

^{*1} The port numbers are fixed.

^{*2} Operators have restrictions on the use of functions. For details, see section “Registering Users” in section 2.7.

2.2 Connecting of the Ethernet Interface

When Connecting Only the CX and Your PC

Connect the CX and your PC using a hub as shown below (the figure below is an example using the CX2000).

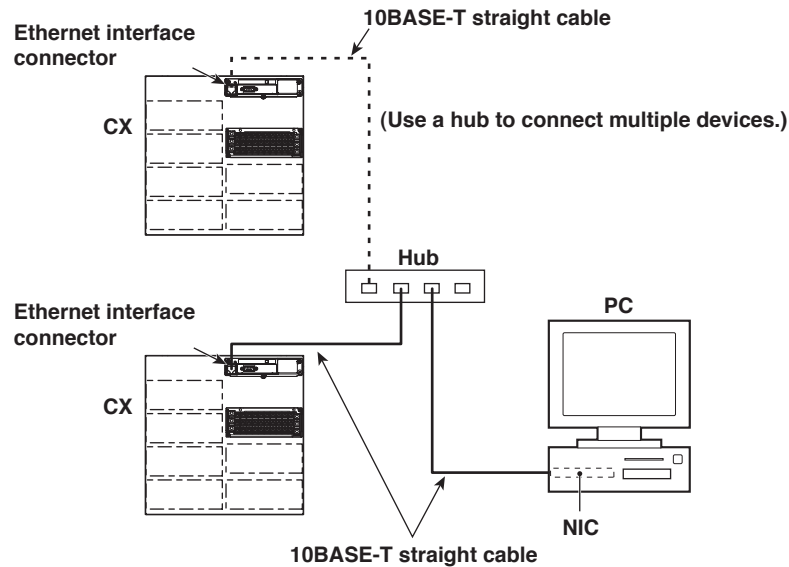

When Connecting to a Preexisting Network

The following figure (the figure below is an example using the CX2000) shows an example in which a single CX and a single PC are connected. When connecting the CX and the PC to a preexisting network, alignment must be made in the transfer speed, connector shape, and other settings. For details, consult your system or network administrator.

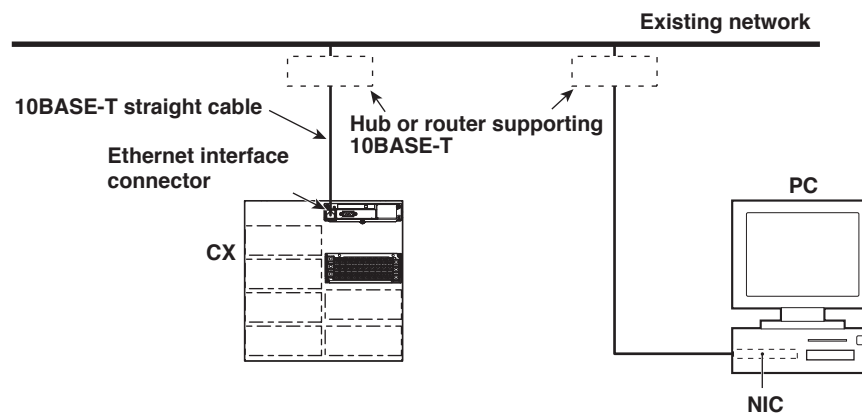

Note

- In some cases, not all the transmitted data may be retrieved by the PC depending on the network conditions such as when there is excessive amount of traffic or when external noise affects the network.
- The communication performance degrades if multiple PCs connect to a single CX simultaneously.
- To reduce noise, use shielded cables (STP) for making connections.

2.3 Configuring of the Ethernet Interface

Explanation

To use the Ethernet communication functions of the CX, the following settings are required:

Setting the IP Address, Subnet Mask, Default Gateway, and DNS

Consult your system or network administrator in setting parameters such as the IP address, subnet mask, default gateway, and DNS (domain name system).

- **IP address**

- Set the IP address to assign to the CX. The default setting is “0.0.0.0.”
- The IP address is used to uniquely identify a device on the Internet when using TCP/IP. The address is a 32-bit value expressed using four octets (each 0 to 255) with each octet separated by a period as in [192.168.111.24].

- **Subnet mask**

- Set the mask value used when determining the subnet network address from the IP address. The default setting is “0.0.0.0.”
- Set the value according to the system or network to which the CX belongs. You may not need to set the value.

- **Default gateway**

- Set the IP address of the gateway (router, etc.) used to communicate with other networks. The default setting is “0.0.0.0.”
- Set the value according to the system or network to which the CX belongs. You may not need to set the value.

- **DNS (Domain Name System)**

DNS is a system used to associate names used on the Internet called host names and domain names to IP addresses. Host names and domain names can be used to access the network instead of using the IP address, which is a sequence of numbers. The DNS server manages the database containing the association of host names and domain names to the IP addresses. If you are specifying the data (file or e-mail) destination server using a host name in the FTP client settings (section 2.5) or e-mail transmission function settings (section 2.11), you must enter the DNS information described here.

- **DNS Server**

- Set the DNS server address. The default setting is “0.0.0.0.”
- You can specify up to two DNS server addresses, primary and secondary. When the primary DNS server is down, the secondary DNS server is automatically looked up for the mapping of the host name/domain name and IP address.

- **Host name**

Set the host name of the CX using up to 64 alphanumeric characters.

- **Domain name**

- Set the name of the network domain that the CX belongs to using up to 64 alphanumeric characters.
- The domain name is appended to the destination host name as a possible domain if the domain is omitted when the transmission destination (server) for the data from the CX is looked up on the DNS server. The name of the transmission destination (server name) is the “FTP server name” specified in section 2.5.

2.3 Configuring of the Ethernet Interface

- **Domain suffix**

When the IP address corresponding to the server name with the domain name of the previous section is not found, the system may be set up to search using a different domain name. In such case, set the domain name to be searched following the “domain name” of the previous section as a domain suffix.

- Enter the name using up to 64 alphanumeric characters.
- You can specify up to two domain suffixes, primary and secondary.

Selecting the Communication Type Used to Output the Data in the Internal Memory and Files on the External Storage Medium

- Select the communication type used to output the data in the internal memory of the CX (display, event, TLOG, manual sample, and report data) and the files on the external storage medium using output commands (ME, MI, and MO commands). Since Ethernet communications and serial communications cannot be used simultaneously as an output destination, either one must be selected.
- To use the Ethernet interface, select [Ethernet].

Saving the Settings

To activate the settings that have been changed in the basic setting mode, the settings must be saved. Otherwise, the settings that existed before the change are activated.

Procedure

For the basic flow of operation, see “Setup Procedure Using Operation Keys” on page ix. For the procedure of entering characters and numbers, see the *user’s manual IM 04L31A01-01E or 04L31A01-03E*.

1. Press the MENU key.
The setting mode (control) display appears.
2. Press the FUNC key for approximately 3 s.
The basic setting menu appears.
3. Press the [#7] (Communication) soft key ([#9] (Communication) soft key on the CX1000).
The communication function setting menu appears.
4. Press the [#1] (Ethernet, Serial) soft key ([#1] (Ethernet (IP_Address)) soft key on the CX1000).
The Communication (Ethernet, Serial) setting display appears.

CX1000 Communication (Ethernet (IP_Address)) setting display

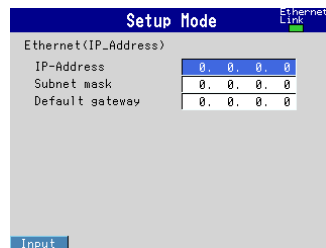

CX2000 Communication (Ethernet, Serial) setting display

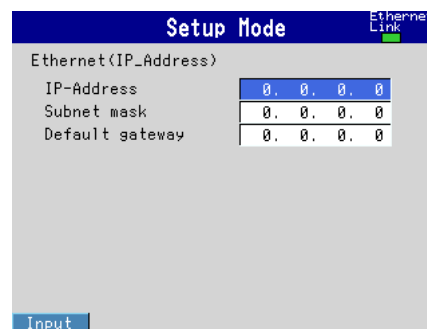

On models without the serial communication function, [Serial] and [Memory out] parameters do not appear.

Setting the IP Address

5. Use the arrow keys to move the cursor to the [IP-address] box.
6. Press the [Input] soft key. An entry box (numeric value input pop-up window) appears.

7. Enter the IP address to be assigned to the CX.
8. Press the DISP/ENTER key. On the CX1000, select [ENT] and then press the DISP/ENTER key.
The IP address that you entered appears in the [IP-address] box.

Setting the Subnet Mask

Set the subnet mask according to the system or network to which the CX belongs. If the subnet mask is not required, proceed to “Setting the Default Gateway.”

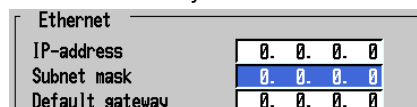
9. Use the arrow keys to move the cursor to the [Subnet mask] box.



10. Press the [Input] soft key. The [Subnet mask] entry box opens.



2.3 Configuring of the Ethernet Interface

11. Enter the subnet mask for the network to which the CX is to be connected.
12. Press the DISP/ENTER key. On the CX1000, select [ENT] and then press the DISP/ENTER key.
The subnet mask value that you entered appears in the [Subnet mask] box.

Setting the Default Gateway

Set the default gateway according to the system or network to which the CX belongs. If the subnet mask is not required, proceed to “Setting the DNS (Domain Name System).”

13. Use the arrow keys to move the cursor to the [Default gateway] box.

Ethernet	
IP-address	0. 0. 0. 0
Subnet mask	0. 0. 0. 0
Default gateway	0. 0. 0. 0

14. Press the [Input] soft key. The entry dialog box opens.

Input
<input type="text"/>

15. Enter the default gateway for the network to which the CX is to be connected.
16. Press the DISP/ENTER key. On the CX1000, select [ENT] and then press the DISP/ENTER key.
The default gateway value that you entered appears in the [Default gateway] box. On the CX1000, confirm the settings here.
To confirm the new settings, press the DISP/ENTER key. To cancel the settings, press the ESC key.
For a detailed procedure in confirming or canceling settings, see “Setup Procedure Using Operation Keys” on page ix.

Setting the DNS (Domain Name System)

If you are specifying the file or e-mail destination server for the FTP client or e-mail transmission function using a host name, enter the settings below. Otherwise, proceed to step 39.

On the CX1000, if you confirmed the settings in step 16, press the ESC key to return to the communication function setting menu of step 4. Then, press the [#2 (Ethernet (DNS))] soft key.

• Turning On/Off the DNS

17. Use the arrow keys to move the cursor to the [DNS On/Off] box.

Default gateway	0. 0. 0. 0
DNS On/Off	Off

18. Press the [On] or [Off] soft key.
When using the DNS, select [On] and carry out the steps from 19 to 38. Otherwise, select [Off] (steps 19 to 38 are not required).

On	Off
<input type="radio"/>	<input type="radio"/>

• Setting the Primary DNS Server Address

19. Use the arrow keys to move the cursor to the [Primary] box.

Server search order	
Primary	0. 0. 0. 0
Secondary	0. 0. 0. 0

20. Press the [Input] soft key. An entry box appears.

Input
<input type="text"/>

21. Enter the address of the primary DNS server in the dialog box.
22. Press the DISP/ENTER key. On the CX1000, select [ENT] and then press the DISP/ENTER key.
The address that you entered is displayed in the [Primary] box.

- **Setting the Secondary DNS Server Address**

Enter the information if the system or network to which the CX belongs uses a secondary DNS server. If this is not necessary, proceed to step 25.

23. Use the arrow keys to move the cursor to the [Secondary] box.

24. Set the address of the secondary DNS server in a similar fashion as described in steps 20 to 22.

- **Setting the Host Name of the CX**

25. Use the arrow keys to move the cursor to the [Host name] box.

26. Press the [Input] soft key. An entry box appears.

27. Enter the host name of the CX in the entry box.
28. Press the DISP/ENTER key. On the CX1000, select [ENT] and then press the DISP/ENTER key.
The host name address that you entered appears in the [Host name] box.

- **Setting the Domain Name to Which the CX Belongs**

29. Use the arrow keys to move the cursor to the [Domain name] box.

30. Press the [Input] soft key. An entry box appears.

31. Enter the domain name of the CX in the entry box.
32. Press the DISP/ENTER key. On the CX1000, select [ENT] and then press the DISP/ENTER key.
The domain name address that you entered appears in the [Domain name] box.

- **Setting the Primary Domain Suffix**

Set this parameter if you require the domain suffix. If this is not necessary, proceed to step 39.

33. Use the arrow keys to move the cursor to the [Primary] box under Domain suffix search order.

34. Press the [Input] soft key. An entry box appears.

2.3 Configuring of the Ethernet Interface

35. Enter the primary domain suffix in the entry box.
36. Press the DISP/ENTER key. On the CX1000, select [ENT] and then press the DISP/ENTER key.
The domain suffix that you entered is displayed in the [Primary] box.

- **Setting the Secondary Domain Suffix**

Set the information if a secondary domain suffix is present. If this is not necessary, proceed to step 39.

37. Use the arrow keys to move the cursor (blue) to the [Secondary] box under Domain suffix search order.

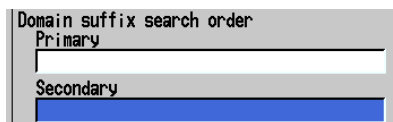

38. Set the address of the secondary domain suffix in a similar fashion as described in steps 34 to 36.

Selecting the Communication Type Used to Output the Data in the Internal Memory and Files on the External Storage Medium

On models without the serial communication function, the [Memory out] item does not appear, because the item does not need be specified.

39. Use the arrow keys to move the cursor to the [Memory out] box.



40. Press the [Ethernet] or [Serial] soft key.
To use the Ethernet interface, press the [Ethernet] soft key.



Confirming or Canceling the Settings

41. To confirm the new settings, press the DISP/ENTER key. To cancel the settings, press the ESC key.
For a detailed procedure in confirming or canceling settings, see "Setup Procedure Using Operation Keys" on page ix.

Saving the Settings

42. Press the ESC key several times to display the basic setting menu.

43. Press the [End] soft key.
A dialog box appears for you to select whether to save the settings.



44. To save the settings, select [Yes]. To not save the settings, select [No]. To return to the basic setting menu, select [Cancel]. Then, press the DISP/ENTER key.



2.4 Checking the Ethernet Interface Connection

Checking the Connection on the Rear Panel of the CX

You can check the connection status of the Ethernet interface by looking at the indicator at the upper right corner of the Ethernet connector of the CX.

Indicator	Connection status of the Ethernet interface
Illuminated (green)	The Ethernet interface is electrically connected.
Blinking (green)	Data transmission in progress.
Not illuminated	The Ethernet interface is not electrically connected.

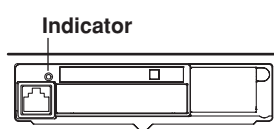

(Rear panel)

Checking the Connection on the CX Display

Checking the Connection at the Status Indication Section of the CX Display

You can check the connection status of the Ethernet interface using the [Ethernet Link] indicator located on the right side of the status indication section of the basic setting menu. The basic setting menu appears by pressing the MENU key to display the setting menu followed by the FUNC key for approximately 3 s.

Indicator	Connection Status of the Ethernet interface
Illuminated (green)	The Ethernet interface is electrically connected.
Not illuminated	The Ethernet interface is not electrically connected.



Checking the Connection Status in the Display Section at the Upper Right Corner of the Communication Log Display of the CX

You can check the connection status of the Ethernet interface using the [Link] indicator on the display section at the upper right corner of the communication log display. For the procedure of displaying the communication log display, see section 2.8.

Indicator	Connection Status of the Ethernet interface
Illuminated (green)	The Ethernet interface is electrically connected.
Not illuminated	The Ethernet interface is not electrically connected.

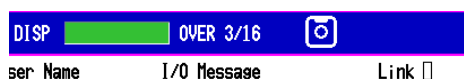

2.5 Setting the FTP Client (Setting the Automatic Transfer of Display, Event, and Report Data Files)

Explanation

By setting this function, the display/event data files created in the internal memory of the CX or report data files can be automatically transferred using FTP at the time the files are created. To use this function, however, the Ethernet interface must be configured as described in section 2.3.

Selecting the Transferred Files

- You can separately select whether to automatically transfer (On/Off) the display/event data files or report data files. The default setting is “Off.”
- The data files are automatically transferred to the FTP destination described in the next section at appropriate times when the [Memory] > [Save] setting is set to [Auto].
 - Display data file: Data files are automatically transferred at auto save intervals or at the specified date and time.
 - Event data file: Data files are automatically transferred when data length of data is written or at every specified date and time.*
 - * Auto transfer at every specified date and time is allowed only during the “Free” mode. For a description of the “Free” mode, see the *user’s manual IM04L31A01-01E* or *IM04L31A01-03E*.
 - Report data file: Data files are automatically transferred every time a report is created.

Note

- For a description of the settings of memory save and auto save interval of the CX, see the *user’s manual IM04L31A01-01E* or *IM04L31A01-03E*.
 - If the [Memory] > [Save] setting of the CX is set to [Manual] (not [auto]), data files are not automatically transferred. You can use commands to transfer display, event, and report data files.
 - For the format of the report data file that is transferred and the report data file that is stored on the external storage medium, see the *user’s manual IM04L31A01-01E* or *IM04L31A01-03E*. However, the report data file that is transferred is divided at each timeout (timeout).
 - If a file with the same name is detected at the destination, the file is transferred with the last character (8th character) of the file name changed.
Example: If the name of the file that you attempted to transfer is “X0212002.CDS” and a file with the same name exists at the destination, it is renamed as “X021200A.CDS” and transferred.
-

Setting the FTP Destination

Consult your system or network administrator in setting parameters such as the primary/secondary FTP servers, port number, login name, password, account, and availability of the PASV mode.

- **Specifying primary and secondary**
You can specify up to two file transfer destinations (FTP servers), primary and secondary, as described in the previous section. The data file is automatically be transferred to the secondary FTP server, if the primary FTP server is down.
- **FTP server name**
Enter the name of the file transfer destination FTP server using up to 64 alphanumeric characters.
 - If the DNS is used, you can set the host name as a server name.
For details on setting the DNS, see section 2.3.
 - You can also set the IP address. In this case, the DNS is not required.

2.5 Setting the FTP Client (Setting the Automatic Transfer of Display, Event, and Report Data Files)

- **Port number**
Enter the port number of the file transfer destination FTP server in the range of 1 to 65535. The default value is 21.
- **Login name**
Enter the login name for accessing the FTP server using up to 32 alphanumeric characters.
- **Password**
Enter the password for accessing the FTP server using up to 32 alphanumeric characters.
- **Account**
Enter the account (ID) for accessing the FTP server using up to 32 alphanumeric characters.
- **PASV mode**
Turn the mode “On” when using the CX behind a firewall that requires the passive mode. The default setting is “Off.” A firewall is furnished on a router (or a similar device) that has security features. It prevents intrusion from the outside into the network system.
- **Initial path**
Enter the directory of the file transfer destination using up to 64 alphanumeric characters. The delimiter for directories varies depending on the implementation of the destination FTP server.

Example When transferring files to the “data” directory in the “home” directory on an FTP server having a UNIX file system
/home/data

Note

If the file transfer to both primary and secondary servers fails, the CX aborts the file transfer. When the connection to the destination recovers, the CX transfers the data files that failed to be transmitted in addition to the new data file. However, since the data that is transferred resides in the internal memory of the CX, if the data is overwritten, the data that could not be transferred is lost. For a description of the data acquisition operation to the internal memory of the CX, see the *user's manual IM04L31A01-01E* or *IM04L31A01-03E*.

Saving the Settings

To activate the settings that have been changed in the basic setting mode, the settings must be saved. Otherwise, the settings that existed before the change are activated.

2.5 Setting the FTP Client (Setting the Automatic Transfer of Display, Event, and Report Data Files)

Procedure

For the basic flow of operation, see “Setup Procedure Using Operation Keys” on page ix. For the procedure of entering characters and numbers, see the *user’s manual IM04L31A01-01E* or *IM04L31A01-03E*.

1. Press the MENU key.
The setting mode (control) display appears.
2. Press the FUNC key for approximately 3 s.
The basic setting menu appears.
3. Press the [#7] (Communication) soft key ([#9] (Communication) soft key on the CX1000).
The communication function setting menu appears.
4. Press the [#2] (FTP client) soft key ([#3] (FTP transfer file) soft key on the CX1000).
The communication setting display appears.

CX1000 Communication (FTP transfer file) setting display

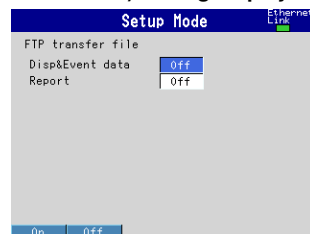

CX2000 Communication (FTP client) setting display

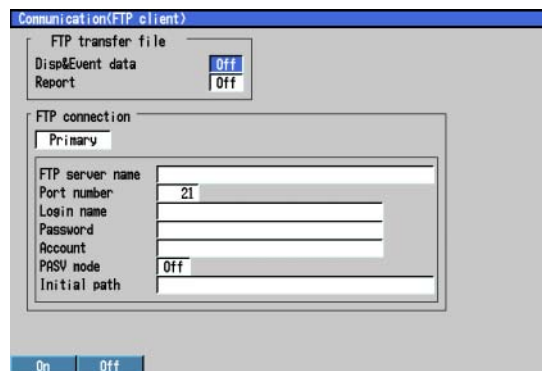

Selecting the Transferred Files

- **Selecting whether to transfer the display/event data files (On/Off)**
5. Use the arrow keys to move the cursor to the [Disp&Event data] box.

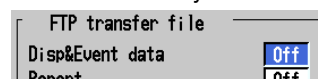

6. Press the [On] or [Off] soft key.



- **Selecting whether to transfer the report data files (On/Off)**

7. Use the arrow keys to move the cursor to the [Report] box.

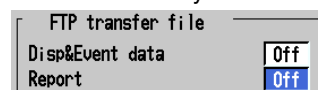

8. Press the [On] or [Off] soft key.



On the CX1000, confirm the settings here.

To confirm the new settings, press the DISP/ENTER key. To cancel the settings, press the ESC key.

For a detailed procedure in confirming or canceling settings, see “Setup Procedure Using Operation Keys” on page ix.

Setting the Primary FTP Connection

On the CX1000, if you confirmed the settings in step 8, press the ESC key to return to the communication function setting menu of step 4. Then, press the [#4 (FTP connection)] soft key.

9. Use the arrow keys to move the cursor to the [FTP connection] box.



10. Press the [Primary] soft key.

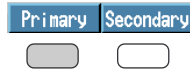

• **Setting the FTP server name**

11. Use the arrow keys to move the cursor to the [FTP server name] box.

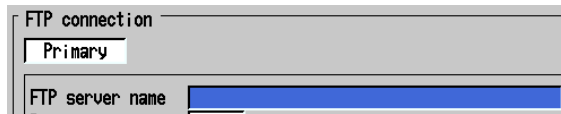

12. Press the [Input] soft key. An entry box (numeric value input pop-up window) appears.



13. Enter the primary FTP server name in the entry box. Normally, an IP address is entered. If the DNS is setup, you can also enter the host name of the FTP server.
14. Press the DISP/ENTER key. On the CX1000, select [ENT] and then press the DISP/ENTER key. The FTP server name that you entered appears in the [FTP server name] box.

• **Setting the port number of the FTP server**

15. Use the arrow keys to move the cursor to the [Port number] box.

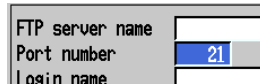

16. Press the [Input] soft key. An entry box appears.



17. Enter the port number of the primary FTP server in the entry box.
18. Press the DISP/ENTER key. On the CX1000, select [ENT] and then press the DISP/ENTER key. The port number that you entered appears in the [Port number] box.

• **Setting the login name for accessing the FTP server**

19. Use the arrow keys to move the cursor to the [Login name] box.



20. Press the [Input] soft key. An entry box appears.



2.5 Setting the FTP Client (Setting the Automatic Transfer of Display, Event, and Report Data Files)

21. Enter the login name for accessing the primary FTP server in the entry box.
22. Press the DISP/ENTER key. On the CX1000, select [ENT] and then press the DISP/ENTER key.
The login name that you entered appears in the [Login name] box.

• Setting the password for accessing the FTP server

23. Use the arrow keys to move the cursor to the [Password] box.

Login name	
Password	
Account	
PASV mode	Off

24. Press the [Input] soft key. An entry box appears.

Input

25. Enter the password for accessing the primary FTP server in the entry box.
26. Press the DISP/ENTER key. On the CX1000, select [ENT] and then press the DISP/ENTER key.
The password that you entered is displayed in the [Password] box.

• Setting the account for accessing the FTP server

27. Use the arrow keys to move the cursor to the [Account] box.

Password	
Account	
PASV mode	Off

28. Press the [Input] soft key. An entry box appears.

Input

29. Enter the account for accessing the primary FTP server in the entry box.
30. Press the DISP/ENTER key. On the CX1000, select [ENT] and then press the DISP/ENTER key.
The account that you entered is displayed in the [Account] box.

• Turning On/Off the PASV mode

31. Use the arrow keys to move the cursor to the [PASV mode] box.

Account	
PASV mode	Off
Initial path	

32. Press the [On] or [Off] soft key.

• Setting the initial path (file transfer destination directory)

33. Use the arrow keys to move the cursor to the [Initial path] box.

PASV mode	Off
Initial path	

- 34. Press the [Input] soft key. An entry box appears.



- 35. Enter the file transfer destination directory in the entry box.
- 36. Press the DISP/ENTER key. On the CX1000, select [ENT] and then press the DISP/ENTER key.
The transfer destination directory that you entered appears in the [Initial path] box.

Setting the Secondary FTP Connection

Set the secondary FTP connection only if you are using a secondary FTP server for transferring files. If not, proceed to step 40.

- 37. Use the arrow keys to move the cursor to the [FTP connection] box.



- 38. Press the [Secondary] soft key.



- 39. Set the secondary FTP connection in a similar fashion as described in steps 11 to 36.

Confirming or Canceling the Settings

- 40. To confirm the new settings, press the DISP/ENTER key. To cancel the settings, press the ESC key.
For a detailed procedure in confirming or canceling settings, see "Setup Procedure Using Operation Keys" on page ix.

Saving the Settings

- 41. Press the ESC key several times to display the basic setting menu.
- 42. Press the [End] soft key.
A dialog box appears for you to select whether to save the settings.



- 43. To save the settings, select [Yes]. To not save the settings, select [No]. To return to the basic setting menu, select [Cancel]. Then, press the DISP/ENTER key.

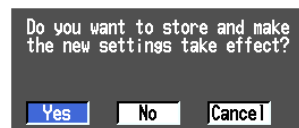

2.6 FTP Test

Explanation

You can test whether files can be transferred via the Ethernet interface by transferring a test file from the CX to the FTP server specified in section 2.5

Items to Check before Performing This Test

- Connect the Ethernet cable correctly. For the connection procedure, see section 2.2.
- Check that the Ethernet interface settings are correct. For the procedure, see section 2.3 or 2.5.

When setting the Ethernet interface, check the settings with your system or network administrator.

Checking the Results of the FTP Test

- When you execute the FTP test, the test file named CX_FTPC.TXT is transferred to the directory indicated by the initial path at the FTP destination specified in section 2.5.
- The result of the FTP test can be confirmed by displaying the FTP log (displayed on the CX (see section 2.8)) or Web screen (see section 2.10) or by outputting the result using the FL command (see section 6.11).

Procedure

Performing the FTP Test

1. Press the FUNC key.
The FUNC menu appears. The structure of the FUNC menu varies depending on the basic settings and options.
2. Press the [FTP test] soft key to display the batch screen.
A destination selection menu for performing the FTP test appears.



3. Press the [Primary] or [Secondary] soft key.
The FTP test of the selected FTP server is executed.

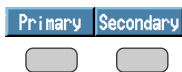

2.7 Setting the Login and Timeout Functions of Ethernet Communications

Explanation

By setting these functions, you can prohibit invalid access from the network to the CX, authorize setup operations of the CX via the Ethernet network, and disconnect connections if there is no data transmission for a certain time. To use this function, however, the Ethernet interface must be configured as described in section 2.3.

Enabling/Disabling the Login Function of the CX

If you enable the login function, only registered users can log in to the CX.

Registering Users

- **Selecting user levels**

Select either user level: ADMINISTRATOR or USER.

- **ADMINISTRATOR**

A single ADMINISTRATOR can be registered. The ADMINISTRATOR has the authority to use all the functions of the Setting/Measurement server, Maintenance/Test server, and FTP server.

- **USER (USER 1 to USER 6)**

Up to 6 USERS can be registered. Certain restrictions exist in using the Setting/Measurement server, Maintenance/Test server, and FTP server. For the restrictions against commands, see section 6.2.

- **Restrictions in using the Setting/Measurement server**

USERS are not authorized to change the settings that would change the operation of the CX. USERS can output measured and setup data.

- **Restrictions in using the Maintenance/Test server**

USERS cannot disconnect connections between other PCs and the CX. USERS can disconnect the connection between their own PC and the CX.

- **Restrictions in using the FTP server**

Files cannot be written to or deleted from the external storage medium of the CX. Files can be read.

- **Selecting whether to register (On/Off)**

- **On**

Registers users. You can set the user name and password for logging in.

- **Off**

Register users.

- **Setting the user name**

- Enter the user name using up to 16 alphanumeric characters.

- You cannot register the same user names.

- You cannot register the user name "quit," because "quit" is used as a command on the CX.

- **Setting the password**

Set the password using up to six alphanumeric characters.

2.7 Setting the Login and Timeout Functions of Ethernet Communications

Note

- The relationship between the login function and the user name for accessing the CX is as follows.
 - **When the login function is set to “Use”**
 - You can log into the CX using the registered user name and password.
 - The user level is the user level specified when the user name was registered.
 - **When the login function is set to “Not”**
 - You can log into the CX as an ADMINISTRATOR by accessing the CX using the user name “admin”. Password is not required.
 - You can log into the CX as a USER by accessing the CX using the user name “user”. Password is not required.
 - The user name “anonymous” has a special meaning only when the FTP server function of the CX is used.
 - **When the login function is set to “Use”**
 - If a user name “anonymous” is registered to the CX, you can log into the CX using the user name “anonymous”.
 - Password is not required (you can log in regardless of whether a password is entered).
 - The user level is the user level specified when the user name “anonymous” was registered.
 - **When the login function is set to “Not”**
 - You can login using the user name “anonymous”.
 - Password is not required (you can log in regardless of whether a password is entered).
 - The user level is USER.
 - There is a limitation on the number of simultaneous connections and the number of simultaneous users accessing the CX (see section 2.1).
-

Application Time Out

- **Selecting On or Off**
 - **On**

If there is no data transmission for a specified time by the various communication functions (see section 1.1), the connection is forcibly disconnected.
 - **Off**

Application time out is disabled.
- **Setting the timeout**

If application time out is enabled, the connection is forcibly disconnected when there is not data transmission for the timeout time specified here.
Selectable range: 1 to 120 minutes.

Enabling/Disabling (On/Off) keep alive

- **On**

If there is no response to the inspection packet that is periodically transmitted (every 30 s) by the TCP protocol, the connection is forcibly disconnected.
- **Off**

Keep alive is disabled.

Saving the Settings

To activate the settings that have been changed in the basic setting mode, the settings must be saved. Otherwise, the settings that existed before the change are activated.

Procedure

For the basic flow of operation, see “Setup Procedure Using Operation Keys” on page ix. For the procedure of entering characters and numbers, see the *user’s manual IM04L31A01-01E* or *IM04L31A01-03E*.

1. Press the MENU key.
The setting mode (control) display appears.
2. Press the FUNC key for approximately 3 s.
The basic setting menu appears.
3. Press the [#7] (Communication) soft key ([#9] (Communication) soft key on the CX1000).
The communication function setting menu appears.
4. Press the [#3] (Control (Login, Timeout)) soft key ([#5] (Control (Login, Timeout)) soft key on the CX1000).
Communication setting display appears.

CX 1000 Communication (Login, Timeout-) setting display

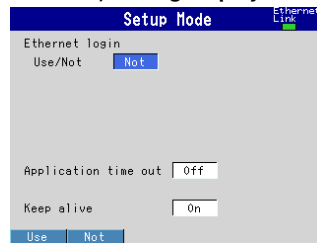

CX 2000 Communication (Control -Login, Timeout-) setting display

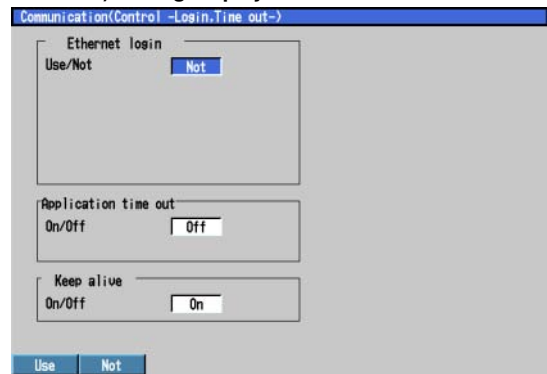

Enabling/Disabling the Login Function of the CX (Use/Not)

5. Use the arrow keys to move the cursor to the [Use/Not] box.

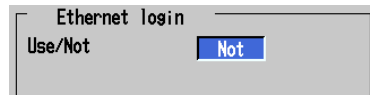

6. Press the [Use] or [Not] soft key.
If you selected [Use] proceed to step 7; if you selected [Not] proceed to step 20.



Registering Users

• **Selecting the user level**

7. Use the arrow keys to move the cursor to the [Level] box.

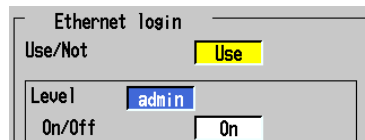

8. Press one of the soft keys from [admin] to [user6] to select the user level.
To set the user level to ADMINISTRATOR, select [admin]; To set the user level to USER, select [user1] to [user6].



2.7 Setting the Login and Timeout Functions of Ethernet Communications

- **Selecting whether to register (On/Off)**

9. Use the arrow keys to move the cursor to the [On/Off] box under Level.

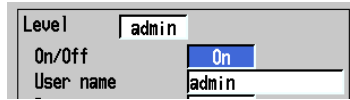

Level	admin
On/Off	On
User name	admin

10. Press the [On] or [Off] soft key.

If you selected [On] proceed to step 11; if you selected [Off] proceed to step 19.

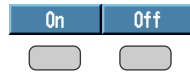

On	Off
----	-----

○ ○

- **Setting the user name**

11. Use the arrow keys to move the cursor to the [User name] box.

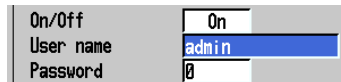

On/Off	On
User name	admin
Password	

12. Press the [Input] soft key. An entry box (numeric value input pop-up window) appears.



Input

○

13. Enter the user name in the entry box.

14. Press the DISP/ENTER key. On the CX1000, select [ENT] and then press the DISP/ENTER key.

The user name that you entered appears in the [User name] box.

- **Set the password**

15. Use the arrow keys to move the cursor to the [Password] box.



User name	admin
Password	

16. Press the [Input] soft key. An entry box appears.



Input

○

17. Enter the password in the entry box.

18. Press the DISP/ENTER key. On the CX1000, select [ENT] and then press the DISP/ENTER key.

The password that you entered is displayed in the [Password] box.

19. To register other users, repeat steps 7 to 18.

Setting the Application Time Out

- **Enabling/Disabling communication timeout (On/Off)**

20. Use the arrow keys to move the cursor to the [On/Off] box under Application time out.

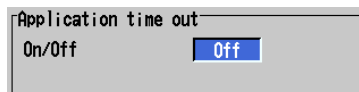

Application time out	
On/Off	Off

21. Press the [On] or [Off] soft key.

If you selected [On] proceed to step 22; if you selected [Off] proceed to step 26.



On	Off
----	-----

○ ○

- **Setting the application time out**

22. Use the arrow keys to move the cursor to the [Time] box.

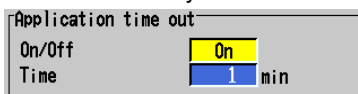

23. Press the [Input] soft key. An entry box appears.



24. Enter the application time out time in the entry box.

25. Press the DISP/ENTER key. On the CX1000, select [ENT] and then press the DISP/ENTER key. The application time out time that you entered appears in the [Time] box.

Enabling/Disabling Keep Alive (On/Off)

26. Use the arrow keys to move the cursor to the [On/Off] box under Keep alive.

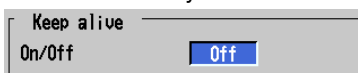

27. Press the [On] or [Off] soft key.



Confirming or Canceling the Settings

28. To confirm the new settings, press the DISP/ENTER key. To cancel the settings, press the ESC key.
For a detailed procedure in confirming or canceling settings, see "Setup Procedure Using Operation Keys" on page ix.

Saving the Settings

29. Press the ESC key several times to display the basic setting menu.
30. Press the [End] soft key. A dialog box appears for you to select whether to save the settings.



31. To save the settings, select [Yes]. To not save the settings, select [No]. To return to the basic setting menu, select [Cancel]. Then, press the DISP/ENTER key.

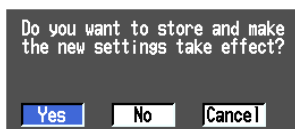

2.8 Displaying the Error, Communication, and FTP Log Screens

Explanation

Displaying the Error Log Screen

The error log screen shows a log of the past 50 operation error messages. Logs older than the past 50 are not saved. For the meaning of the messages, see appendix 7, "Messages."

CX2000 screen example

(002/002) Time	No.	Message
Jan. 06. 2000 06:12:01	282	"FTP control connection error."
Jan. 06. 2000 06:12:01	210	"Media has not been inserted."

↑ Date/time when the error occurred ↑ Error code ↑ Error message
 The section of messages that exceeds the number of characters above is displayed as ",".

Displaying the Communication Log Screen

The communication log screen shows a log of the past 200 communication commands/responses. Logs older than the past 200 are not saved. For the meaning of the messages, see "Communication Log" in section 7.2.

CX2000 screen example

(007/007) Time	ID	User Name	I/O Message	Link
Jan. 06. 2000 18:52:23	1	user	< (Logout)	
Jan. 06. 2000 18:52:23	1	user	> CC 0	
Jan. 06. 2000 18:51:48	1	user	< (259)	
Jan. 06. 2000 18:51:48	1	user	> FD 0,001,010	← Message (up to 20 characters)
Jan. 06. 2000 18:51:41	1	user	< E0	
Jan. 06. 2000 18:51:41	1	user	> B0 0	
Jan. 06. 2000 18:51:37	1	user	< (Login)	

↑ Date/time the CX was accessed ↑ ID ↑ Name of the user who accessed the CX (user name registered in section 2.7)
 ↑ Number identifying the connected user (See "Communication Log" in section 7.2)
 ↑ Input/output signal (>: input, <: output)

Displaying the FTP Log Screen

The FTP log screen shows a log of the past 50 FTP file transfers. Logs older than the past 50 are not saved. For the meaning of the messages, see appendix 7, "Messages."

CX2000 screen example

(005/005) Time	No.	Code	Flag	File Name
Jan. 01. 2000 01:50:22	282	HOSTNAME	S	10101500.DDS
Jan. 01. 2000 01:50:22	282	UNREACH	P	10101500.DDS
Jan. 01. 2000 01:49:32			P	10101490.DDS ← File name (8 characters)
Jan. 01. 2000 01:48:51			P	10101480.DDS
Jan. 01. 2000 01:48:27			P	CX_FTPC.TXT

↑ Date/time when file was transferred ↑ Error code ↑ FTP connection destination (P: primary, S: secondary)

Displaying the Web Browser Operation Log Screen

The Web browser operation log screen shows a log of the past 50 Web browser operations. Logs older than the past 50 are not saved. For the meaning of the messages, see “Web Operation Log” in section 7.2.

CX2000 screen example

<004/004>	Time	Request	No.	Parameter
Jan. 07. 2001	01:19:12	Message	155	2:stop
Jan. 07. 2001	01:18:29	Message		1:start
Jan. 07. 2001	01:18:15	Key		UP
Jan. 07. 2001	01:17:58	Screen		DIGITAL GROUP=1

↑ Date/time when the operation was carried out on the Web screen.
 ↑ Operation type
 ↑ Error code (see *User's Manual IM 04L31A01-01E*)
 ↑ Operation information

Displaying the E-mail Log Screen

The e-mail log screen shows a log of the past 50 e-mail transmissions. Logs older than the past 50 are not saved. For the meaning of the messages, see “E-mail Log” in section 7.2.

CX2000 screen example

<010/010>	Time	Type	No.	Recipient / Error
Jan. 05. 2000	01:08:58	Error	1+2	Yokogawa Satoh
Jan. 05. 2000	01:08:45	Test	1	Yokogawa
Jan. 05. 2000	01:06:30	Full	1+2	Yokogawa Satoh
Jan. 05. 2000	01:00:01	Time	1	Yokogawa
Jan. 05. 2000	00:26:01	Report	1+2	Yokogawa Satoh
Jan. 05. 2000	00:23:33	Alarm	1	Yokogawa
Jan. 05. 2000	00:23:29	Alarm	1	Yokogawa
Jan. 05. 2000	00:22:00	Test	2	Satoh
Jan. 05. 2000	00:21:51	Test	266	2 Ethernet cable is not connected.
Jan. 05. 2000	00:19:37	Test	1	Yokogawa

↑ Date/time
 ↑ Mail type
 ↑ Recipient No.
 ↑ Recipient address
 ↑ Error code (see appendix 7)

Note

- There is also a log screen that shows a log of login/logout operations. For a description of how to display this screen, see the *user's manual IM04L31A01-01E* or *IM04L31A01-03E*.
- You can also use commands to output the error, communication, FTP, Web operation, and e-mail log data. For the output format, see section 7.2.

Procedure

Displaying the Error Log Screen

1. Press the FUNC key.
The FUNC menu appears. The structure of the FUNC menu varies depending on the basic settings and options.
2. Press the [Log] soft key.
The log screen selection menu appears.



3. Press the [Error] soft key.
The error log screen appears.



Displaying the Communication Log Screen

1. Press the FUNC key.
The FUNC menu appears. The structure of the FUNC menu varies depending on the basic settings and options.
2. Press the [Log] soft key.
The log screen selection menu appears.



3. Press the [Commu] soft key.
The communication log screen appears.



Displaying the FTP Log Screen

1. Press the FUNC key.
The FUNC menu appears. The structure of the FUNC menu varies depending on the basic settings and options.
2. Press the [Log] soft key.
The log screen selection menu appears.



3. Press the [FTP] soft key.
The FTP log screen appears.



Displaying the Web Browser Operation Log Screen

1. Press the FUNC key.
The FUNC menu appears. The structure of the FUNC menu varies depending on the basic settings and options.
2. Press the [Log] soft key.
The log screen selection menu appears.



3. Press the [Web] soft key. The Web operation log screen appears.



Displaying the E-mail Log Screen

1. Press the FUNC key.
The FUNC menu appears. The structure of the FUNC menu varies depending on the basic settings and options.
2. Press the [Log] soft key.
The log screen selection menu appears.



3. Press the [E-Mail] soft key.
The E-mail log screen appears.



2.9 Setting the Web Server Function

Explanation

To use the Web server function, set the following parameters in addition to those described in section 2.3.

Enabling/Disabling the Web Server Function

Select [Use] or [Not] (don't use).

Page Type (Type of Screen to Be Displayed)

- **Monitor**

- The screen displayed on the CX is displayed.
- The following information can be displayed.
 - Alarm summary
 - Measurement/computation channel values
 - Control channel values
 - Log (error message log, login/logout log, FTP file transfer log, e-mail transmission log, and Web browser operation log)
- For screen examples, see section 2.10.

- **Operator**

The following operations can be carried out in addition to the functions available on the monitor page.

- Switch the screen on the CX using the display selection menus.
- Operate the DISP/ENTER key and arrow keys on the CX.
- Set messages on the CX and write them.
- For screen examples, see section 2.10.

Monitor Page

- **Selecting whether to use the monitor page**

- **On**

The monitor page can be displayed on a Web browser.

- **Off**

Disables the use of the monitor page.

- **Selecting whether use the access control**

- **On**

Enables the use of access control. You must enter the user name and password to display the monitor page.

- **Off**

Disables the use of access control.

- **Setting the user name**

Set the user name using up to 16 alphanumeric characters.

- **Setting the password**

Set the password using up to six alphanumeric characters.

Operator Page

- **Selecting whether to use the operator page**

- **On**

The operator page can be displayed on a Web browser.

- **Off**

Disables the use of the operator page.

- **Selecting whether to use command input**
 - **On**
Enables the use of message setting/writing commands.
 - **Off**
Disables the use of message setting/writing commands.
- **Selecting whether to use access control**
 - **On**
Enables the use of access control. You must enter the user name and password to display the operator page.
 - **Off**
Disables the use the access control.
- **Setting the user name**
Enter the user name using up to 16 characters.
- **Setting the password**
Set the password using up to six alphanumeric characters.

Saving the Settings

To activate the settings that have been changed in the basic setting mode, the settings must be saved. Otherwise, the settings that existed before the change are activated.

Setting the Time Difference from Greenwich Mean Time

See section 3.7, “Changing the Time Zone” in the *user’s manual IM 04L31A01-01E* or *IM 04L31A01-03E*.

2.9 Setting the Web Server Function

Procedure

For the basic flow of operation, see “Setup Procedure Using Operation Keys” on page ix. For the procedure of entering characters and numbers, see the *user’s manual IM 04L31A01-01E* or *IM 04L31A01-03E*.

1. Press the MENU key.
The setting mode (control) display appears.
2. Press the FUNC key for approximately 3 s.
The basic setting menu appears.
3. Press the [#8] (Web, E-Mail) soft key ([#10] (Web, E-Mail) soft key on the CX1000).
The Web, Email setting menu appears.
4. Press the [#1] (Web) soft key.
The Web, Email (Web) setting display appears.

CX1000 Web setting display

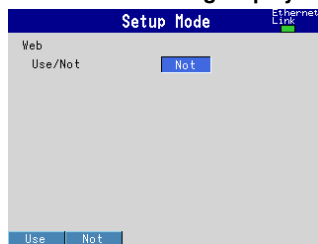

CX2000 Web, E-mail (Web) setting display

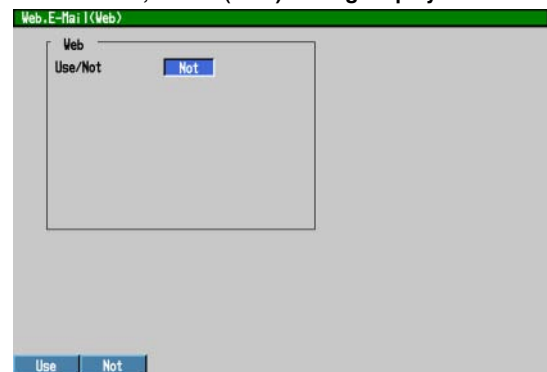

Enabling/Disabling the Web Server Function

5. Use the arrow keys to move the cursor to the [Use/Not] box.

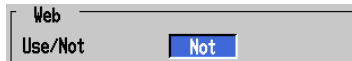

6. Press the [Use] or [Not] soft key. If you selected [Use] proceed to step 7; if you selected [Not] proceed to step 28.



Selecting the Page Type

7. Use the arrow keys to move the cursor to the [Page type] box.

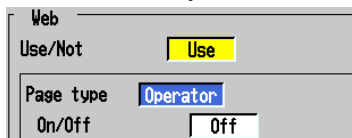

8. Press the [Operator] or [Monitor] soft key. If you selected [Operator] proceed to step 9; if you selected [Monitor] proceed to step 23.

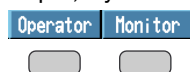

Setting the Operator Page**• Turning On/Off the operator page**

9. Use the arrow keys to move the cursor to the [On/Off] box.

Web	
Use/Not	Use
Page type	Operator
On/Off	Off

10. Press the [On] or [Off] soft key. If you selected [On] proceed to step 11; if you selected [Off] proceed to step 28.

On	Off
<input type="radio"/>	<input type="radio"/>

• Turning On/Off the use of command input

11. Use the arrow keys to move the cursor to the [Command] box.

Page type	Operator
On/Off	On
Command	Off
Access control	Off

12. Press the [On] or [Off] soft key.

On	Off
<input type="radio"/>	<input type="radio"/>

• Turning On/Off access control

13. Use the arrow keys to move the cursor to the [Access control] box.

Page type	Operator
On/Off	On
Command	Off
Access control	Off

14. Press the [On] or [Off] soft key. If you selected [On] proceed to step 15; if you selected [Off] proceed to step 28.

On	Off
<input type="radio"/>	<input type="radio"/>

• Setting the user name

15. Use the arrow keys to move the cursor to the [User name] box.

Access control	On
User name	
Password	

16. Press the [Input] soft key. An entry box (numeric value input pop-up window) appears.

Input
<input type="text"/>

17. Enter the user name in the entry box.

18. Press the DISP/ENTER key. On the CX1000, select [ENT] and then press the DISP/ENTER key.

The user name that you entered appears in the [User name] box.

• Setting the password

19. Use the arrow keys to move the cursor to the [Password] box.

Access control	On
User name	
Password	

2.9 Setting the Web Server Function

20. Press the [Input] soft key. An entry box appears.



21. Enter the password in the entry box.
22. Press the DISP/ENTER key. On the CX1000, select [ENT] and then press the DISP/ENTER key.
The password that you entered is displayed in the [Password] box.

Setting the Monitor Page

- **Turning On/Off the monitor page**

23. Use the arrow keys to move the cursor to the [On/Off] box.

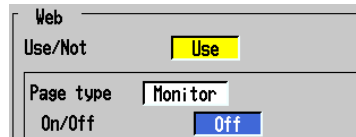

24. Press the [On] or [Off] soft key.
If you selected [On] proceed to step 25; if you selected [Off] proceed to step 28.



- **Turning On/Off access control**

25. Follow the procedures of steps 13 and 14.

- **Setting the user name**

26. Follow the procedures of steps 15 through 18.

- **Setting the password**

27. Follow the procedures of steps 19 through 22.

Confirming or Canceling the Settings

28. To confirm the new settings, press the DISP/ENTER key. To cancel the settings, press the ESC key.
For a detailed procedure in confirming or canceling settings, see "Setup Procedure Using Operation Keys" on page ix.

Saving the Settings

29. Press the ESC key several times to display the basic setting menu.
30. Press the [End] soft key. A dialog box appears for you to select whether to save the settings.



31. To save the settings, select [Yes]. To not save the settings, select [No]. To return to the basic setting menu, select [Cancel]. Then, press the DISP/ENTER key.



2.10 Using the Monitor Page and Operator Page

Explanation

This section describes how to display the monitor page and operator page and the operation on each page.

Web Browsers That Can Be Used

Operations have been confirmed on the following Web browsers.

- Microsoft Internet Explorer 4.0 to 5.5

Setting the URL

Set the URL (Uniform Resource Locator) appropriately according to the network environment that you are using. You can access the CX by setting the URL as follows:

http://host name.domain name/file name

- http: Protocol used to access the server. HTTP stands for HyperText Transfer Protocol.
- Host name.domain name: Host name and domain name of the CX. You can also use the IP address in place of the host name and domain name.
- File name: File name of the monitor page and operator page of the CX.

File name of the monitor page: **monitor.htm**

File name of the operator page: **operator.htm**

Omitting the file name is equivalent to specifying the monitor page. However, if the monitor page is disabled, it is equivalent to specifying the operator page.

Example

To display the operator page using Internet Explorer on a PC in the same domain as the CX (the domain name, host name, and IP address are assumed to be good.com, CX, and 123.456.789.123, respectively).

Address: **http://CX.good.com/operator.htm** or

Address: **http://123.456.789.123/operator.htm**

Contents of the Monitor Page

CX2000 screen example

The screenshot displays the CX2000 monitor page with the following data:

Process	Mode	PV (°C)	SP (°C)	OUT (%)
TIC-101	MAN	0.01	77.00	0.0
TIC-102	MAN	25.4	600.0	0.0
TIC-103	MAN	+*****	51.50	0.0
TIC-104	MAN	+*****	61.0	0.0
TIC-105	MAN	+*****	115.9	0.0
TIC-001	MAN	244.6		

Labels in the image point to the 'Auto refresh' and 'Zoom in/out' controls at the top, the 'Display menu section' (Refresh, Alarm Summary, Meas.Math Channels, Control Channels, Log) below the menu, and the 'Monitor screen' area containing the data grid.

2.10 Using the Monitor Page and Operator Page

- **Screen displayed by the CX**

- If the CX is in the operation mode,* the monitor screen displayed on the CX (control, trend, digital, bar graph, overview, alarm summary, message summary, memory summary, report, or historical trend) is displayed on the monitor page.
- If the CX is in the setting mode* or basic setting mode,* the monitor screen cannot be displayed. An error message is displayed in the message area at the top section of the monitor screen.

* For a description of the modes, see the *user's manual IM04L31A01-01E or IM04L31A01-03E*.

- **Refreshing the Monitor Page**

The monitor page can be refreshed automatically or manually.

- **Auto Refresh ON**

The monitor page is refreshed at a refresh rate of approximately 30 s.

- **Auto Refresh OFF**

Monitor page is not automatically refreshed. You can refresh the page manually. Within 30 s of the last refreshing, the page is not refreshed even if you attempt to refresh the page manually.

- **Zooming in or out of the screen**

The CX screen that is displayed on the monitor page can be reduced to 75% in size (expanded to 200% on the CX1000).

- **Displaying the alarm summary**

You can display the alarm summary. Click the “Refresh” button to refresh the data.

Refresh the data

Refresh		Close		Creation date : Jan.03.2001 00:18:11			
Channel	Type	Alarm IN Time		Alarm OUT Time			
7	2L	Jan.03.2001 00:17:51					
9	2L	Jan.03.2001 00:17:42					
4	1H	Jan.03.2001 00:16:15		Jan.03.2001 00:17:55			
2	1H	Jan.03.2001 00:16:15		Jan.03.2001 00:17:55			

- **Displaying measured/computed data**

You can display the measured/computed data (excluding measurement channels set to skip and computation channels set to Off). Click the “Refresh” button to refresh the data.

Refresh		Close		Creation date : Jan.01.2001 02:22:03					
Channel	Alarm status	1				Reading	Units		
		1	2	3	4				
1	H H L L					-0.798	V		
2	H L					-0.797	V		
3	R r					-0.796	V		
4	H H					-0.796	V		
5	L L					-0.795	V		

- **Displaying control data**

You can display the control data (excluding internal and external loops that are turned off). Click the “Refresh” button to refresh the data.

Refresh		Close		Creation date : Jan.07.2000 16:29:19					
Channel	Alarm status	1				Reading	Units		
		1	2	3	4				
INT-01.PV	H					-0.381	V		
INT-01.SP	L					-0.386	V		
INT-01.OUT	R					-0.390	V		
INT-02.PV	T					-0.396	V		

Note

The “o” set on the CX is displayed as “^” on the Web browser.

• **Displaying the log**

You can display the communication command log, error message log, FTP file transfer log, login/logout log, Web browser operation log, and e-mail transmission log. Click the “Refresh” button to refresh the data.

Communication Command

Date	Message	User
Jan.01.2001 02:29:03	2 stop	[Communication]
Jan.01.2001 02:28:48	1 start	[Communication]

Select the log.
Refresh the data.

Error Message

Date	No.	Message
Jan.01.2001 02:25:00	210	Media has not been inserted.
Jan.01.2001 02:25:00	282	FTP control connection error.

FTP File Transfer

Date	No. / Code	Flag	File Name
Jan.01.2001 02:25:00	282 HOSTNAME	S	10102240.DDS
Jan.01.2001 02:25:00	283 USER	P	10102240.DDS

Login/logout

Date	L/O	No.	User Name
Jan.01.2001 02:27:08	In	01	user1
Jan.01.2001 02:24:10	In	01	user1

E-mail Transmission

Date	Type	No.	Recipient / Error
Jan.03.2001 00:09:36	Alarm		1 Haruo_Saitou
Jan.03.2001 00:09:31	Error	264	1+2 Some recipients' addresses are invalid.

2.10 Using the Monitor Page and Operator Page

Web Browser Operation

LOG			
WEB			
Refresh	Close	Creation date : Jan.01.2001 02:34:40	
Date	Request	No.	Parameter
Jan.01.2001 02:34:28	Key		DISP/ENTER
Jan.01.2001 02:31:23	Key		UP

Contents of the Operator Page CX2000 screen example

Auto refresh Zoom in/out

Display menu section

- Refresh the display
- Alarm summary display
- Measured/computed data display
- Control data display
- Log display
- Set/write messages

Displayed when command input on the operator page is turned On in #8 Web, Email setting (#10 on the CX1000) of the basic setting mode.

Display switching operation section

Arrow keys and the DISP/ENTER key

Display reduced to 75%

The monitor screen section is reduced.

On the operator page, the following operations can be carried out in addition to the information available on the monitor page.

- **Switching displays**

You can switch the monitor screen on the CX by specifying the group that is displayed on the trend, numerical, bar graph, controller, faceplate, and hybrid displays. On models with the program control option (/PG1 or /PG2), you can also switch to the program selection display (when program control is stopped) and the program control display (when program control is running).

- **Operating the CX using the DISP/ENTER key and arrow keys on the operator page**

If the CX is in the operation mode, you can use the DISP/ENTER key and arrow keys on the operator page to carry out the same operations as the DISP/ENTER key and arrow keys on the CX. However, you cannot perform operations related to the control function such as switching modes and running/stopping operations.

- **Setting and writing messages**

You can set the message string for messages 1 through 8 on the CX (16 alphanumeric characters) and, at the same time, display them on the trend display and write them to the internal memory. Existing messages are overwritten.

Using the Monitor Page

This section gives an overview of the operations. Follow the operating procedures on your PC.

Procedure

1. Start the Web browser and open the monitor page of the CX. If access control is specified, proceed to step 2. Otherwise, proceed to step 5.

Note

The monitor page can be displayed when the CX is in the operation mode. An error message is displayed when the CX is in the setting mode or basic setting mode. For details on the operation mode, setting mode and basic setting mode, see the *user's manual IM 04L31A01-01E* or *IM 04L31A01-03E*.

Entering the User Name and Password

- **Entering the user name**

2. A window appears for you to enter the user name and password. Enter the user name in the [User Name] box.

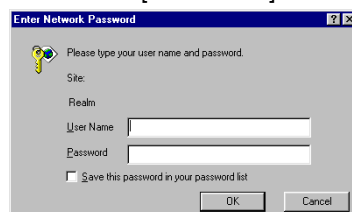

- **Entering the password**

3. Enter the password.
All characters are displayed as asterisks (*).
If the "Save the password" check box is selected, the window appears with the saved password entered the next time (all characters are displayed as asterisks (*)).
4. Click [OK] to display the monitor page.

Auto Refreshing the Display

5. Click the [Auto Refresh] box to specify [ON] or [OFF].

Refreshing the Display Manually

6. Click [Refresh] in the display menu section to refresh the page.

2.10 Using the Monitor Page and Operator Page

Zooming in or out of the Display

7. Click [Zoom] to specify [100%] or [75%] ([200%] on the CX1000).

Displaying the Alarm Summary

8. Click [Alarm Summary] in the display menu section to display the alarm summary.
Click [Refresh] to refresh the alarm summary information.
Click [Close] to close the alarm summary window.

Displaying Measurement/Computation Channel Information or Control Channel Information

9. Click [Meas-Math Channels] or [Control Channels] in the display menu section to display the measured/computed data or control data, respectively.
Click [Refresh] to refresh the measured/computed/control data.
Click [Close] to close the measured/computed/control data window.

Displaying the Log

10. Click [Log] in the display menu section to display the log.
Click the box used to select the log type. The selected type of log is displayed.
Click [Refresh] to refresh the log information.
Click [Close] to close the log window.

Using the Operator Page

This section gives an overview of the operations. Follow the operating procedures on your PC.

Procedure

1. Start the Web browser and open the operator page of the CX.

Note

Operator page can be displayed when the CX is in the operation mode. An error message is displayed when the CX is in the setting mode or basic setting mode. For details on the operation mode, setting mode and basic setting mode, see the *user's manual IM 04L31A01-01E* or *IM 04L31A01-03E*.

The following operations are the same as the monitor page. See “Using the Monitor Page.”

Entering the User Name and Password

Auto Refreshing the Display

Refreshing the Display Manually

Zooming in or out of the Display

Displaying the Alarm Summary

Displaying Measured/Computed Data

Displaying the Log

Operations Only on the Operator Page

• Setting/Modifying and writing messages

[Message] in the display menu section appears only when the use of command input is enabled in the operator page settings.

11. Click [Message] in the display/operation menu section to display the Active Message window.

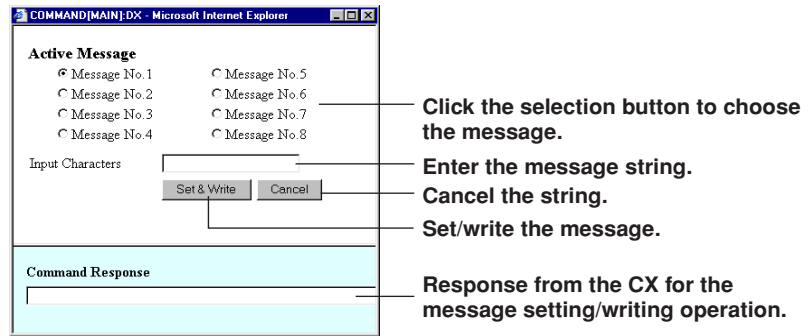

12. Click the message number button to select the message.
13. Enter the message string (up to 16 alphanumeric characters) in the message box and click [Set & Write].
The message on the CX is set, and the message appears on the trend display on the CX. The message is also written to the internal memory.
To cancel the operation, click [Cancel].

Note

- The message is displayed on the trend display and written to the internal memory only when the data write operation to the internal memory is in progress on the CX (the message is set regardless of whether or not the data write operation to the internal memory is in progress).
- The response to the message setting and writing operations is displayed in the command response section.

Switching Displays

14. Click [Select group] of the trend, digital, bar graph, controller, faceplate, or hybrid display in the display switch section to select the group. The CX screen changes to the specified display. The operator page is also refreshed. On models with the program control option (/PG1 or /PG2), you can also switch to the program selection display and the program control display.

CX2000 screen example

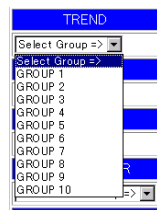

Switching Displays Using the DISP/ENTER Key and Arrow Keys

You can switch the trend, digital, bar graph, controller, faceplate, and hybrid displays.

15. Click the DISP/ENTER key or arrow keys that are displayed on the operator page to operate the CX in the same fashion as the corresponding keys on the CX. The operator page is also refreshed.

2.11 Setting the E-mail Transmission Function

Explanation

To use the e-mail transmission function, set the following parameters in addition to those described in section 2.3.

Basic Settings of E-mail

- **SMTP* server name**
If the DNS is specified (see section 2.3), you can set the SMTP server name using up to 64 alphanumeric characters. You can also set the IP address of the SMTP server.
* Simple Mail Transfer Protocol
- **Port number**
Set the port number to be used. The initial value is 25.
- **Recipient 1**
Set the recipient of the e-mail message using up to 150 alphanumeric characters. You can specify multiple addresses by delimiting the addresses using spaces.
- **Recipient 2**
Set the recipient of the e-mail message using up to 150 alphanumeric characters. You can specify multiple addresses by delimiting the addresses using spaces.
- **Sender**
Set the e-mail address that has been provided by the network administrator using up to 64 alphanumeric characters. If omitted, the sender is set to the first address specified as the recipient.

Settings for Transmitting Alarm Information

The alarm information is sent when either the control or measurement alarm occurs.

- **Recipient 1, Recipient 2**
You can turn On/Off the function for each recipient.
 - **On**
Transmits e-mail messages to the recipient.
 - **Off**
Does not transmit e-mail messages to the recipient.
- **Alarm number for sending the alarm information via e-mail (alarm 1, alarm 2, alarm 3, and alarm 4)**
You can turn On/Off the function for each alarm number. This setting applies to all channels.
 - **On**
If the status of any one of the alarms assigned to the alarm number changes (alarm occurrence or release), an e-mail message is transmitted.
 - **Off**
The alarm information of the alarm number is not transmitted.
- **Contents of the transmitted mail**
 - **Including instantaneous values**
 - **On**
The instantaneous values of all channels are included in the e-mail message.
 - **Off**
The instantaneous values are not included in the e-mail message.
 - **Including the source URL (Uniform Resource Locator)**
 - **On**
If the Web server function is specified on the CX, the URL of the CX is attached to the e-mail.
 - **Off**
The URL of the CX is not attached to the e-mail.

- **Subject**
Set the subject of the e-mail message using up to 32 alphanumeric characters. The default value is "(CX)Alarm_summary."
- **Header 1**
Set the string to be attached to the e-mail message using up to 64 alphanumeric characters.
- **Header 2**
Set the string to be attached to the e-mail message using up to 64 alphanumeric characters.

Settings When Transmitting E-mail Messages at the Specified Time

- **Recipient 1, Recipient 2**
You can turn On/Off the function for each recipient.
 - **On**
Transmits e-mail messages to the recipient.
 - **Off**
Does not transmit e-mail messages to the recipient.
- **Interval**
Time interval used to repeat the e-mail transmission starting from the [Ref.time].
Select from the following:
OFF, 1h, 2h, 3h, 4h, 6h, 8h, 12h, and 24h
- **Ref. time**
Set the time "hour:minute" to transmit the e-mail message. The e-mail transmission is repeated every interval from this point. Specify the time in the following range for each recipient.
00:00 to 23:59
Example: If Reference time is 17:15 and Interval is 8h, e-mail messages are transmitted at 17:15, 01:15, and 09:15.
- **Contents of the transmitted mail**
 - **Including instantaneous values**
 - **On**
Includes the instantaneous values of all channels at the time of e-mail transmission in the e-mail message.
 - **Off**
The instantaneous values are not included in the e-mail message.
 - **Including the source URL (Uniform Resource Locator)**
 - **On**
If the Web server function is specified on the CX, the URL of the CX is attached to the e-mail.
 - **Off**
The URL of the CX is not attached to the e-mail.
- **Subject**
Set the subject of the e-mail message using up to 32 alphanumeric characters. The default value is "(CX)Periodic_data."
- **Header 1**
Set the string to be attached to the e-mail message using up to 64 alphanumeric characters.
- **Header 2**
Set the string to be attached to the e-mail message using up to 64 alphanumeric characters.

Settings When Transmitting E-mail Messages at the Time of Recovery from a Power Failure (System E-Mail Settings)

- **Recipient 1, Recipient 2**

You can turn On/Off the function for each recipient.

 - **On**

Transmits e-mail messages to the recipient.
 - **Off**

Does not transmit e-mail messages to the recipient.
- **Contents of the transmitted mail**
 - **Including the source URL (Uniform Resource Locator)**
 - **On**

If the Web server function is specified on the CX, the URL of the CX is attached to the e-mail.
 - **Off**

The URL of the CX is not attached to the e-mail.
 - **Subject**

Set the subject of the e-mail message using up to 32 alphanumeric characters. The default value is "(CX)System_warning."
 - **Header 1**

Set the string to be attached to the e-mail message using up to 64 alphanumeric characters.
 - **Header 2**

Set the string to be attached to the e-mail message using up to 64 alphanumeric characters.

Settings When Transmitting E-mail Messages at the Time of Reports Are Created (Only on Models with the Computation Function Option (/M1))

- **Recipient 1, Recipient 2**

You can turn On/Off the function for each recipient.

 - **On**

Transmits e-mail messages to the recipient.
 - **Off**

Does not transmit e-mail messages to the recipient.
- **Contents of the transmitted mail**
 - **Including the source URL (Uniform Resource Locator)**
 - **On**

If the Web server function is specified on the CX, the URL of the CX is attached to the e-mail.
 - **Off**

The URL of the CX is not attached to the e-mail.
 - **Subject**

Set the subject of the e-mail message using up to 32 alphanumeric characters. The default value is "(CX)Report_data."
 - **Header 1**

Set the string to be attached to the e-mail message using up to 64 alphanumeric characters.
 - **Header 2**

Set the string to be attached to the e-mail message using up to 64 alphanumeric characters.

Saving the Settings

To activate the settings that have been changed in the basic setting mode, the settings must be saved. Otherwise, the settings that existed before the change are activated.

Note

The "o" set on the CX is displayed as "^" on the Web browser.

Procedure

For the basic flow of operation, see “Setup Procedure Using Operation Keys” on page ix. For the procedure of entering characters and numbers, see the *user's manual IM 04L31A01-01E* or *IM 04L31A01-03E*.

1. Press the MENU key.
The setting mode (control) display appears.
2. Press the FUNC key for approximately 3 s.
The basic setting menu appears.
3. Press the [#8] (Web, E-Mail) soft key ([#10] (Web, E-Mail) soft key on the CX1000).
The Web, E-mail setting menu appears.

Setting [Basic E-Mail settings]

4. Press the [#2] (Basic E-Mail settings) soft key .
The Web, Email (Basic E-Mail settings) display appears.

CX1000 Basic E-Mail settings display

CX2000 Web, Email (Basic E-Mail settings) display

• Setting the SMTP server name

5. Use the arrow keys to move the cursor to the [SMTP server name] box.

6. Press the [Input] soft key. An entry box (numeric value input pop-up window) appears.

7. Enter the SMTP server name in the entry box.
8. Press the DISP/ENTER key. On the CX1000, select [ENT] and then press the DISP/ENTER key. The SMTP server name that you entered appears in the [SMTP server name] box.

• Setting the port number

9. Use the arrow keys to move the cursor to the [Port number] box.

2.11 Setting the E-mail Transmission Function

10. Press the [Input] soft key. An entry box appears.



11. Enter the port number in the entry box.
12. Press the DISP/ENTER key. On the CX1000, select [ENT] and then press the DISP/ENTER key.
The port number that you entered appears in the [Port number] box.

• Setting Recipient 1

13. Use the arrow keys to move the cursor to the [Recipient 1] box.



14. Press the [Input] soft key. An entry box appears.



15. Enter the recipient address in the entry box.
When entering multiple address, delimit each address with a space.
16. Press the DISP/ENTER key. On the CX1000, select [ENT] and then press the DISP/ENTER key.
The addresses that you entered are displayed in the [Recipient 1] box.

• Setting Recipient 2

17. Use the arrow keys to move the cursor to the [Recipient 2] box.
18. Set the recipient 2 addresses in the same fashion as the recipient 1 addresses.

• Setting the sender address

19. Use the arrow keys to move the cursor to the [Sender] box.



20. Press the [Input] soft key. An entry box appears.



21. Enter the sender address in the entry box.
22. Press the DISP/ENTER key. On the CX1000, select [ENT] and then press the DISP/ENTER key.
The addresses that you entered are displayed in the [Sender] box.

• Confirming or Canceling the Settings

23. To confirm the new settings, press the DISP/ENTER key. To cancel the settings, press the ESC key.
For a detailed procedure in confirming or canceling settings, see "Setup Procedure Using Operation Keys" on page ix.
Proceed to step 24.

Setting [Alarm], [Scheduled], [System], and [Report]

24. Press the ESC key to return to the Web, E-mail setting menu.
Press the soft key corresponding to the item you wish to set.
The respective setting display appears.
Setting [Alarm E-Mail settings]: Proceed to step 25.
Setting [Scheduled E-Mail settings]: Proceed to step 42.
Setting [System E-Mail settings]: Proceed to step 54.
Setting [Report E-Mail settings]: Proceed to step 59.

Setting [Alarm E-Mail settings]**• Setting the e-mail recipient**

25. Use the arrow keys to move the cursor to the [Recipient 1] or [Recipient 2] box.
The respective recipient address appears.

26. Press the [On] or [Off] soft key.

• Specifying the alarm number for sending the alarm information using e-mail

27. Use the arrow keys to move the cursor to one of the [Alarm1] to [Alarm4] boxes.

28. Press the [On] or [Off] soft key.

• Selecting to include instantaneous values (contents of the transmitted e-mail)

29. Use the arrow keys to move the cursor to the [Include INST] box.

30. Press the [On] or [Off] soft key.

• Selecting to include the source URL (contents of the transmitted e-mail)

31. Use the arrow keys to move the cursor to the [Include source URL] box.

32. Press the [On] or [Off] soft key.

2.11 Setting the E-mail Transmission Function

- **Setting the e-mail subject (contents of the transmitted e-mail)**

33. Use the arrow keys to move the cursor to the [Subject] box.



34. Press the [Input] soft key. An entry box appears.



35. Enter the e-mail subject in the entry box.

36. Press the DISP/ENTER key. On the CX1000, select [ENT] and then press the DISP/ENTER key.

The subject that you entered is displayed in the [Subject] box.

- **Setting the e-mail header**

37. Use the arrow keys to move the cursor to the [Header1] or [Header2] box.



38. Press the [Input] soft key. An entry box appears.



39. Enter the header in the entry box.

40. Press the DISP/ENTER key. On the CX1000, select [ENT] and then press the DISP/ENTER key.

The subject that you entered is displayed in the selected [Header] box.

- **Confirming or Canceling the Settings**

41. To confirm the new settings, press the DISP/ENTER key. To cancel the settings, press the ESC key.

For a detailed procedure in confirming or canceling settings, see “Setup Procedure Using Operation Keys” on page ix.

Setting [Scheduled E-Mail settings]

- **Setting the e-mail recipient**

42. Follow the procedures of steps 25 and 26.

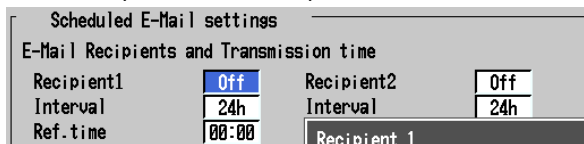

- **Setting the interval**

43. Use the arrow keys to move the cursor to the [Interval] box.



44. Press the soft key corresponding to the interval you wish to select.



- **Setting the Ref.time**

45. Use the arrow keys to move the cursor to the [Ref.time] box.

Recipient1	Off	Recipient2	Off
Interval	24h	Interval	24h
Ref.time	00:00	Ref.time	00:00

46. Press the [Input] soft key. An entry box appears.

Input

47. Enter the reference time in the entry box.
48. Press the DISP/ENTER key. On the CX1000, select [ENT] and then press the DISP/ENTER key.
The reference time that you entered is displayed in the [Ref.time] box.

- **Selecting to include instantaneous values (contents of the transmitted e-mail)**

49. Follow the procedures of steps 29 and 30.

- **Selecting to include the source URL (contents of the transmitted e-mail)**

50. Follow the procedures of steps 31 and 32.

- **Setting the e-mail subject (contents of the transmitted e-mail)**

51. Follow the procedures of steps 33 through 36.

- **Setting the e-mail header (contents of the transmitted e-mail)**

52. Follow the procedures of steps 37 through 40.

- **Confirming or Canceling the Settings**

53. To confirm the new settings, press the DISP/ENTER key. To cancel the settings, press the ESC key.
For a detailed procedure in confirming or canceling settings, see "Setup Procedure Using Operation Keys" on page ix.

Setting [System E-Mail settings]

- **Setting the e-mail recipient**

54. Follow the procedures of steps 25 and 26.

- **Selecting to include the source URL (contents of the transmitted e-mail)**

55. Follow the procedures of steps 31 and 32.

- **Setting the e-mail subject (contents of the transmitted e-mail)**

56. Follow the procedures of steps 33 through 36.

- **Setting the e-mail header (contents of the transmitted e-mail)**

57. Follow the procedures of steps 37 through 40.

2.11 Setting the E-mail Transmission Function

- **Confirming or Canceling the Settings**

58. To confirm the new settings, press the DISP/ENTER key. To cancel the settings, press the ESC key.

For a detailed procedure in confirming or canceling settings, see "Setup Procedure Using Operation Keys" on page ix.

Setting [Report E-Mail settings]

- **Setting the e-mail recipient**

59. Follow the procedures of steps 25 and 26.

- **Selecting to include the source URL (contents of the transmitted e-mail)**

60. Follow the procedures of steps 31 and 32.

- **Setting the e-mail subject (contents of the transmitted e-mail)**

61. Follow the procedures of steps 33 through 36.

- **Setting the e-mail header (contents of the transmitted e-mail)**

62. Follow the procedures of steps 37 through 40.

- **Confirming or Canceling the Settings**

63. To confirm the new settings, press the DISP/ENTER key. To cancel the settings, press the ESC key.

For a detailed procedure in confirming or canceling settings, see "Setup Procedure Using Operation Keys" on page ix.

Saving the Settings

64. Press the ESC key several times to display the basic setting menu.

65. Press the [End] soft key.

A dialog box appears for you to select whether to save the settings.



66. To save the settings, select [Yes]. To not save the settings, select [No]. To return to the basic setting menu, select [Cancel]. Then, press the DISP/ENTER key.



2.12 E-mail Transmission Test

Explanation

You can transmit test e-mail messages to recipient 1 or recipient 2 that you specified in section 2.11 to confirm whether e-mail messages can be transmitted.

Items to Check before Performing This Test

- Connect the Ethernet cable correctly. For the connection procedure, see section 2.2.
- Check that the Ethernet interface settings are correct. For the procedure, see section 2.3 or 2.5.
- Check that the e-mail settings are correct. For the procedure, see section 2.11.

When setting the Ethernet interface or e-mail, check the settings with your system or network administrator.

Checking the Results of the E-mail Transmission Test

- The result of the e-mail transmission test can be confirmed by displaying the e-mail log (displayed on the CX (see section 2.8)) or Web screen (see section 2.10) or by outputting the result using the FL command (see section 6.11).
- If an error message is displayed on the CX, see appendix 7, "Messages."

Contents of the Test E-mail Message

The figure below shows the contents of the test e-mail message. If a message is specified, <Message> is written under <Time>

Test mail example

```
From: CX@good.com
Date: Sat, 23 Dec 2000 07:25:20 +0900 (JST)
Subject: (CX) Test_mail
To: user1@good.com

Test mail.
<Host name>
CX

<Time>
Dec.23 07:25:20
```

Procedure

Performing the E-mail Transmission Test

1. Press the FUNC key.
The FUNC menu appears. The structure of the FUNC menu varies depending on the basic settings and options.

2. Press the [E-Mail test] soft key.
A menu appears for you to select the recipient for the e-mail transmission test.



3. Press the [Recipient 1] or [Recipient 2] soft key.
The e-mail transmission test to the selected recipient is executed.



2.13 Starting/Stopping E-mail Transmissions

Explanation

Starting/Stopping E-mail Transmissions

- If the e-mail transmission is started, the e-mail transmission function is activated.
- If the e-mail transmission is stopped, e-mail transmission is disabled. Unsent e-mail messages are cleared.

Note

- If the CX enters the basic setting mode while the e-mail transmission is started, the e-mail transmission is stopped. If the CX returns to the operation mode from the basic setting mode, the condition that existed before entering the basic setting mode is resumed.
- If e-mail transmission fails, the message is retransmitted up to twice at 30-s intervals. If retransmission fails, the e-mail message is discarded.

Contents of the E-mail Message

The figure below shows examples of an e-mail messages.

Alarm e-mail

From: CX@good.com Date: Sun, 24 Dec 2000 13:08:23 +0900 (JST) Subject: (CX) Alarm_summary To: user1@good.com, user2@good.com	Subject
LOOP1 TEMPERATURE	Header1 Header2
Alarm summary. <Host name> CX	
<CH>03 <Type>1R <On>Dec.24 13:05:16 <Off>Dec.24 13:08:17	Channel no. Alarm no./type Alarm occurrence/ release date/time
<Inst. value> Dec.24 13:08:17 01=-0.312V 02=-0.267V 03=-0.245V . . 29=-0.645V 30=-0.649V	Instantaneous values (when included) • Date/Time • Channel number • Inst. value
Access the following URL in order to look at http://CX.good.com/	Sender URL (when included)

Report e-mail

From: CX@good.com Date: Sat, 23 Dec 2000 23:00:09 +0900 (JST) Subject: (CX) Report_data To: user1@good.com, user2@good.com	Subject
LOOP1 DAILY RAW MATERIAL	Header1 Header2
Hourly report. <Host name> CX	
Dec.23 23:00:00 <CH>01 <Ave>-0.226 <Max>0.698 <Min>-0.972 <Sum>-1.537000E+01 <Unit>V	Date/time Channel no. Report data • Average • Maximum • Minimum • Sum • Unit
<CH>02 <Ave>-0.225 <Max>0.700 <Min>-0.971 .	

Scheduled e-mail

From: CX@good.com Date: Sat, 23 Dec 2000 01:00:09 +0900 (JST) Subject: (CX) Periodic_data To: user1@good.com	Subject
LOOP1 Scheduled	Header1 Header2
Periodic data. <Host name> CX	
<Time> Dec.23 01:00:01	

System e-mail (power recoery)

From: CX@good.com Date: Sat, 23 Dec 2000 07:31:58 +0900 (JST) Subject: (CX) System_warning To: user1@good.com, user2@good.com	Subject
LOOP1 RAW MATERIAL	Header1 Header2
Power failure. <Host name> CX	Cause of e-mail transmission
<Power fail>Dec.23 07:30:12 <Power on>Dec.23 07:31:32	Details

Procedure**Starting the E-mail Transmission**

1. Press the FUNC key.
The FUNC menu appears. The structure of the FUNC menu varies depending on the basic settings and options.
2. Press the [E-Mail START] soft key.
The e-mail transmission function is enabled. An e-mail transmission function icon is displayed in the status indication section of the CX.

**Stopping the E-mail Transmission**

1. Press the FUNC key.
The FUNC menu appears. The structure of the FUNC menu varies depending on the basic settings and options.
2. Press the [E-Mail STOP] soft key. E-mail transmission is stopped. The e-mail transmission function icon disappears from the status indication section of the CX.

**Note**

[E-Mail START] and [E-Mail STOP] appears in the FUNC key menu, if recipient 1 or recipient 2 is On in Alarm E-Mail settings, Scheduled E-Mail settings, System E-Mail settings, or Report E-Mail settings.

2.14 Processing during Recovery of the DO/Internal Switch Communication Buffer

Set the operation to be performed for recovery of the control output DO/internal switch communication buffer when turning the power ON, or when returning to operation mode from basic setting mode. The communication buffer is the internal area that stores the DO/internal switch ON/OFF setting status through communications.

Continue [1]: Holds the status of the control output DO and internal switches

Clear: Clears the status of the control output DO and internal switches

Procedure

1. Press the MENU key.
The setting mode (control) display appears.
2. Press the FUNC key for approximately 3 s.
The basic setting menu appears.
3. Press the [#7] (Communication) soft key ([#9] (Communication) soft key on the CX1000).
Communication setting menu appears.
4. Press the [#5] (AUX) soft key ([#9] (AUX) soft key on the CX1000).
Communication (AUX) setting display appears.

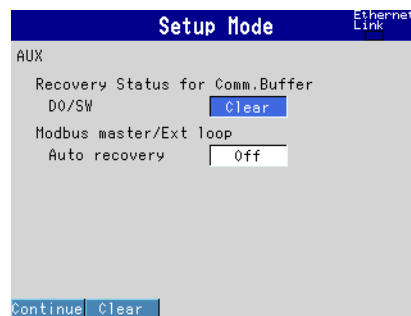

5. Use the arrow keys to move the cursor to the [DO/SW] box.
6. Press the [Continue] or [Clear] soft key.

Confirming or Canceling the Settings

7. To confirm the new settings, press the DISP/ENTER key. To cancel the settings, press the ESC key.
For a detailed procedure in confirming or canceling settings, see "Setup Procedure Using Operation Keys" on page ix.

Saving the Settings

8. Press the ESC key several times to display the basic setting menu.
9. Press the [End] soft key. A dialog box appears for you to select whether to save the settings.
10. To save the settings, select [Yes]. To not save the settings, select [No]. To return to the basic setting menu, select [Cancel]. Then, press the DISP/ENTER key.



3.1 Serial Interface Specifications

The specifications of the two types of serial interfaces (options), RS-232 and RS-422/485, of the CX are given below.

RS-232 Specifications

Connector type	D-Sub 9-pin plug
Electrical and mechanical specifications	Conforms to EIA-574 (9-pin EIA-232 (RS-232))
Connection	Point-to-point
Transmission mode	Half-duplex
Synchronization	Start-stop synchronization
Baud rate	Select from 1200, 2400, 4800, 9600, 19200, and 38400 [bps].
Start bit	Fixed to 1 bit
Data length	Select 7 or 8 bits
To output data in BINARY format, make sure to set the data length to 8 bits.)	
Parity	Select Odd, Even, or None (no parity).
Stop bit	Fixed to 1 bit
Hardware handshaking	Select whether to set the RS and CS signals to TRUE always or use them as control lines.
Software handshaking	Select whether to use the X-ON and X-OFF signals to control the transmission data or both transmission and reception data. X-ON (ASCII 11H) and X-OFF (ASCII 13H)
Received buffer length	2047 bytes

RS-422/485 Specifications

Terminal block type	Number of terminals: 6, terminal attachment screws: ISO M4/nominal length of 6 mm
Electrical and mechanical specifications	Conforms to EIA-422 (RS-422) and EIA-485 (RS-485)
Connection	Multidrop For a four-wire system 1:32 For a two-wire system 1:31
Transmission mode	Half-duplex
Synchronization	Start-stop synchronization
Baud rate	Select from 1200, 2400, 4800, 9600, 19200, and 38400 [bps].
Start bit	Fixed to 1 bit
Data length	Select 7 or 8 bits
Parity	Select Odd, Even, or None (no parity).
Stop bit	Fixed to 1 bit
Received buffer length	2047 bytes
Escape sequence	Open and close
Electrical characteristics	6 points consisting of FG, SG, SDB, SDA, RDB, and RDA The SG, SDB, SDA, RDB, and RDA terminals and the internal circuitry of the CX are functionally isolated. The FG terminal is the frame ground.
Communication distance	Up to 1.2 km
Terminator	External: Recommended resistance is 120 Ω , 1/2 W

3.2 Connector Pin Arrangement and Signal Names, Connection Procedure, and Handshaking Methods of the RS-232 Interface

Connector Pin Arrangement and Signal Names

Connector Pin Arrangement

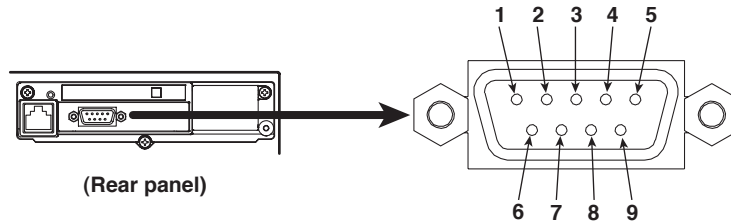

Pin No.	Signal Name	Meaning
2	RD (Received Data)	Received data from the PC. Input signal to the CX.
3	SD (Send Data)	Transmitted data to the PC. Output signal from the CX.
5	SG (Signal Ground)	Signal ground.
7	RS (Request to Send)	Handshaking signal when receiving data from the PC. Output signal from the CX.
8	CS (Clear to Send)	Handshaking signal when transmitting data to the PC. Input signal to the CX.

* Pins 1, 4, 6, and 9 are not used.

Serial (RS-232) Standard Signals and Their JIS and ITU-T Abbreviations

Pin No. (9-pin connector)	Abbreviation			Description
	RS-232	ITU-T	JIS	
5	AB (GND)	102	SG	Signal ground
3	BA (TXD)	103	SD	Transmitted data
2	BB (RXD)	104	RD	Received data
7	CA (RTS)	105	RS	Request to send
8	CB (CTS)	106	CS	Clear to send

Connection Procedure

Signal Direction

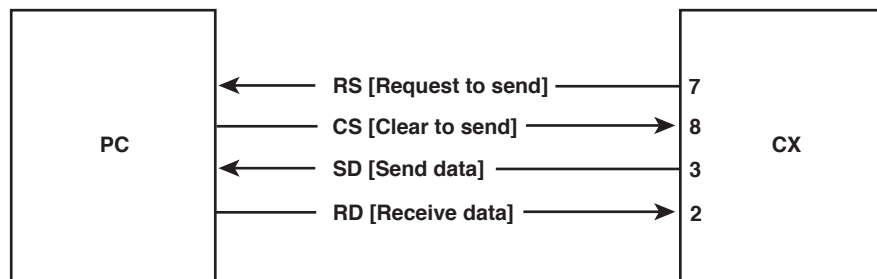

Connection Examples

• OFF-OFF/XON-XON

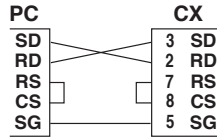

• CS-RS(CTS-RTS)

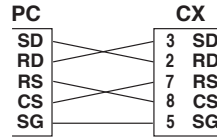

• XON-RS(XON-RTS)

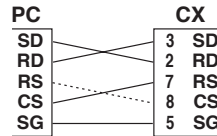

The RS on the PC side and the CX on the CX side do not need to be connected for control. However, it is recommended that you do so, so that the cable can be connected in either direction.

Note

To reduce noise, use shielded cables (STP) for making connections.

Handshaking

When using the RS-232 interface for transferring data, it is necessary for equipment on both sides to agree on a set of rules to ensure the proper transfer of data. The set of rules is called handshaking. Because there are various handshaking methods that can be used between the CX and the PC, one must make sure that the same method is chosen by both the CX and the PC.

You can choose any of the four methods on the CX in the table below.

Table of Handshaking Methods (Yes: indicates that it is supported)

Handshaking Method	Data Transmission Control (Control used to send data to a PC)			Data Reception Control (Control used to receive data from a PC)		
	Software handshaking	Hardware handshaking	No handshaking	Software handshaking	Hardware handshaking	No handshaking
	Stops transmission when X-OFF is received. Resume when X-ON is received.	Stops transmission when CB (CTS) is false. Resume when it is true.		Send X-OFF when the received data buffer is 3/4th filled. Send X-ON when the received data buffer becomes 1/4th filled.	Set CA (RTS) to False when the received data buffer is 3/4th filled. Set to True when the received data buffer becomes 1/4th filled.	
OFF-OFF			Yes			Yes
XON-XON	Yes			Yes		
XON-RS	Yes				Yes	
CS-RS		Yes			Yes	

OFF-OFF

- Data transmission control
There is no handshaking between the CX and the PC. The “X-OFF” and “X-ON” signals received from the PC are treated as data, and the CS signal is ignored.
- Data reception control
There is no handshaking between the CX and the PC. When the received buffer becomes full, all of the data that overflows are discarded.
RS = True (fixed).

3.2 Connector Pin Arrangement and Signal Names, Connection Procedure, and Handshaking Methods

XON-XON

- Data Transmission Control
Software handshaking is performed between the CX and the PC. When an “X-OFF” code is received while sending data to the PC, the CX stops the data transmission. When the CX receives the next “X-ON” code, the CX resumes the data transmission. The CS signal received from the PC is ignored.
- Data Reception Control
Software handshaking is performed between the CX and the PC. When the free area of the received buffer decreases to 1537 bytes, the CX sends an “X-OFF” code. When the free area increases to 511 bytes, the CX sends an “X-ON” code. RS = True (fixed).

XON-RS

- Data Transmission Control
Software handshaking is performed between the CX and the PC. When an “X-OFF” code is received while sending data to the PC, the CX stops the data transmission. When the CX receives the next “X-ON” code, the CX resumes the data transmission. The CS signal received from the PC is ignored.
- Data Reception Control
Hardware handshaking is performed between the CX and the PC. When the free area of the received buffer decreases to 1537 bytes, the CX sets “RS=False.” When the free area increases to 511 bytes, the CX sets “RS=True.”

CS-RS

- Data Transmission Control
Hardware handshaking is performed between the CX and the PC. When the CS signal becomes False while sending data to the PC, the CX stops the data transmission. When the CS signal becomes True, the CX resumes the data transmission. The “X-OFF” and “X-ON” signals are treated as data.
- Data Reception Control
Hardware handshaking is performed between the CX and the PC. When the free area of the received buffer decreases to 1537 bytes, the CX sets “RS=False.” When the free area increases to 511 bytes, the CX sets “RS=True.”

Note

- The PC program must be designed so that the received buffers of both the CX and the PC do not become full.
 - If you select XON-XON, send the data in ASCII format.
-

3.3 Terminal Arrangement and Signal Names and the Connection Procedure of the RS-422/485 Interface

Terminal Arrangement and Signal Names

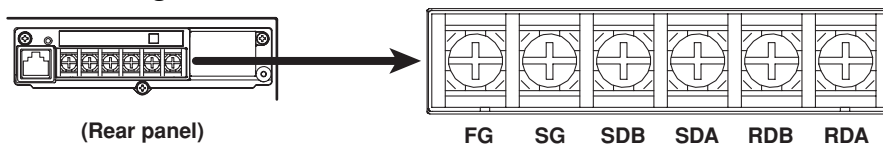

FG (Frame Ground)	Case ground of the CX.
SG (Signal Ground)	Signal ground.
SDB (Send Data B)	Send data B (+)
SDA (Send Data A)	Send data A (-)
RDB (Received Data B)	Receive data B (+)
RDA (Received Data A)	Receive data A (-)

Connection Procedure

Cable

There are two types of cables available, the four-wire cable and the two-wire cable (used only for the Modbus protocol). The cable should meet the following specifications.

Cable	Shielded twisted pair cable 3 pairs 24AWG or more (four-wire), 2 pair 24AWG or more (two-wire)
Characteristic impedance	100 Ω
Capacitance	50 pF/m
Cable length	Up to 1.2 km*

* The transmission distance of the RS-422/485 interface is not the straight-line distance, but rather the total length of the (shielded twisted-pair) cable.

Connecting the Cable

As shown in the following figure, attach a crimp-on lug with isolation sleeves for 4 mm screws to the end of the cable. Keep the exposed section from the end of the shield within 5 cm.

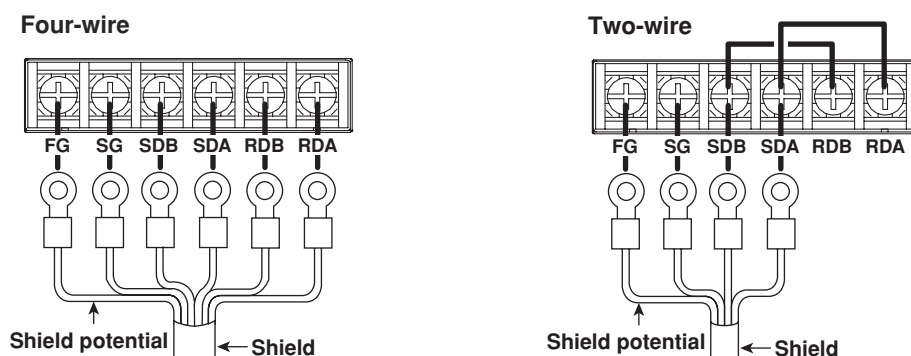

WARNING

To prevent the possibility of electric shock, connect the cables with the power turned OFF.

Note

- As shown on the next page, connect the RD pin to the SD (TD) pin on the PC (converter) side and the SD pin to the RD pin on the PC side.
- The two-wire cable can be used only when using the Modbus protocol.

3.3 Terminal Arrangement and Signal Names and the Connection Procedure of the RS-422/485 Interface

Connection Example with the Other Instruments

You can connect the CX as a host to multiple Green series controllers or connect the CX to a host computer such as a PC.

- If the host uses an RS-232 interface, use a converter. For recommended converters, see the latter section “Serial Interface Converter.”
- The two-wire cable can be used only when using the Modbus protocol. For the configuration procedure, see section 3.5.

Four-Wire System

In general, the instrument and the host computer are connected with the transmission and reception lines crossed. Terminal instruments are connected to each other using straight connections.

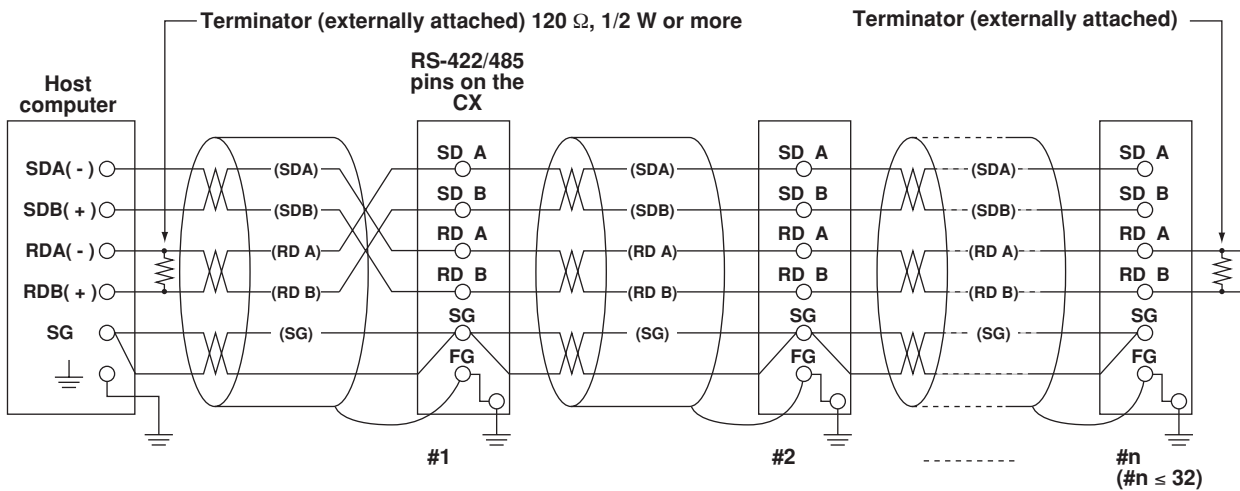

Do not connect terminators to #1 through #n-1.

The following diagram illustrates the case when the host computer's interface is RS-232.

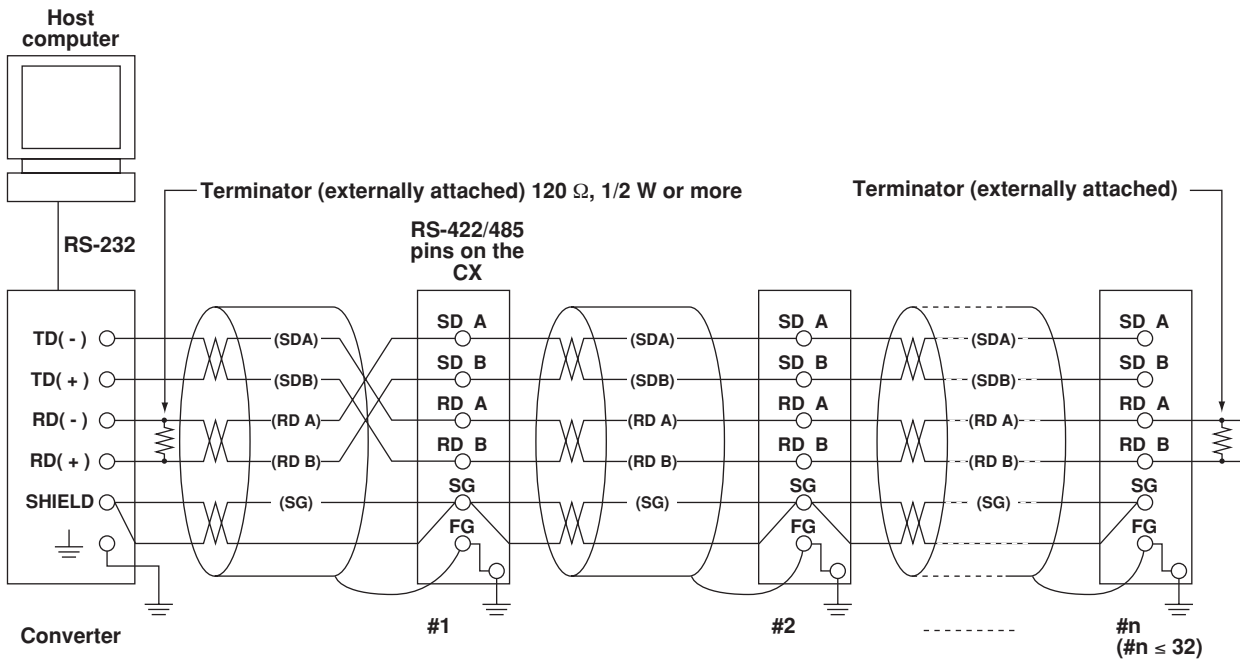

Do not connect terminators to #1 through #n-1.

3.3 Terminal Arrangement and Signal Names and the Connection Procedure of the RS-422/485 Interface

Two-Wire System

Connect the transmission and reception signals with the same polarity on the RS-422/485 terminal block. The two-wire cable can be used only when using the Modbus protocol. Connect terminators ($120\ \Omega$ 1/2 W or more) to the signal line of the host computer and the terminal at the of the chain.

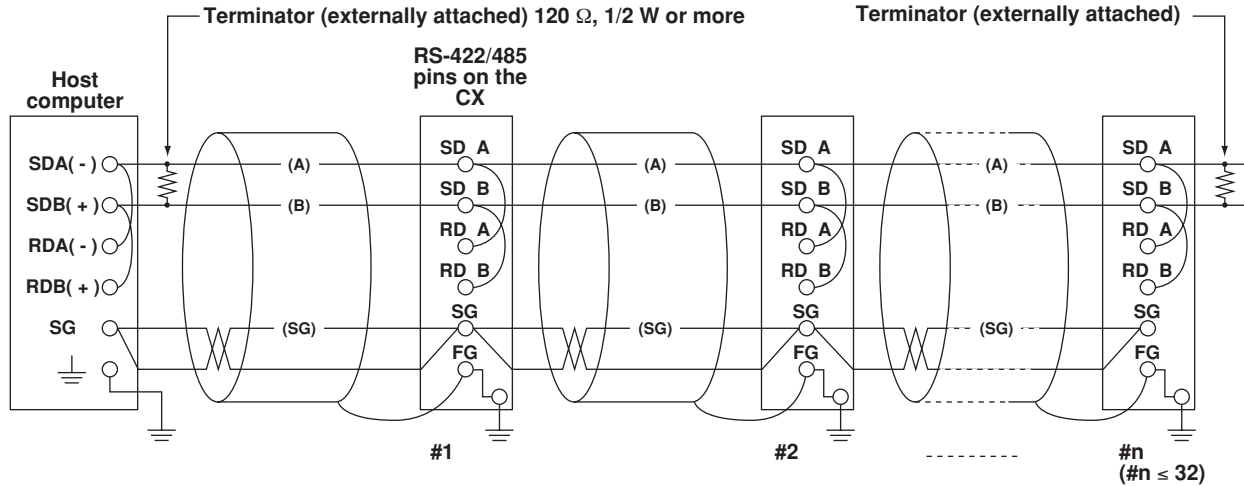

Do not connect terminators to #1 through #n-1.

The following diagram illustrates the case when the host computer's interface is RS-232.

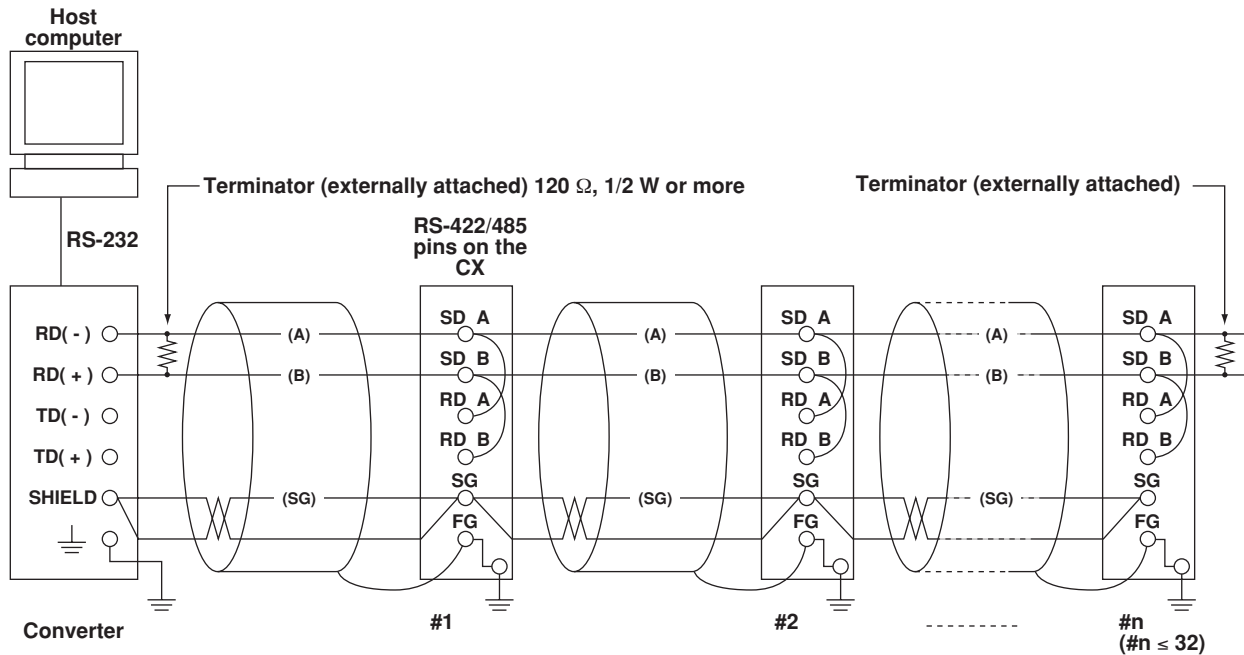

Do not connect terminators to #1 through #n-1.

Note

- The method used to eliminate noise varies depending on the situation. In the connection example, the shield of the cable is connected only to the FG terminal (ground) (one-sided grounding). This is effective when there is a difference in the electric potential between the host computer's ground and the CX's ground. This may be the case for long distance communications. If there is no difference in the electric potential between the host computer's ground and the CX's ground, the method of connecting the shield also to the host computer's ground may be effective (two-sided grounding). In addition, in some cases, using two-sided grounding with a capacitor connected in series on one side is effective. Consider these possibilities to eliminate noise.
- When using the two-wire interface (Modbus protocol), the 485 driver must be set to high impedance within 3.5 characters after the last data byte is sent by the host computer.
- There is no problem of connecting a $220\text{-}\Omega$ terminator at either end if YOKOGAWA's PLCs or temperature controllers are also connected to the communication line.

Serial Interface Converter

Recommended converter

SYSMEX RA CO.,LTD./MODEL RC-770X, LINE EYE/SI-30FA, YOKOGAWA/ML2



CAUTION

Some converters not recommended by Yokogawa have FG and SG pins that are not isolated. In this case, do not follow the diagram on the previous page (do not connect anything to the FG and SG pins). Especially in the case of long distance communications, the potential difference that appears may damage the CX or cause communication errors. For converters that do not have the SG pin, they can be used without using the signal ground. For details, see the manual that came with the converter.

On some non-recommended converters, the signal polarity may be reversed (A/B or +/- indication). In this case, reverse the connection.

For a two-wire system, the host computer must control the transmission driver of the converter in order to prevent collisions of transmit and received data. When using the recommended converter, the driver is controlled using the RS (RTS) signal on the RS-232.

When Instruments That Support Only the RS-422 Interface Exist in the System

When using the four-wire system, up to 32 CXs can be connected to a single host computer. However, this may not be true if instruments that support only the RS-422 interface exist in the system.

When YOKOGAWA's Recorders That Support Only the RS-422 Interface Exist in the System

The maximum number of connection is 16. Some of YOKOGAWA's conventional recorders (HR2400 and mR, for example) only support the RS-422 driver. In this case, only up to 16 units can be connected.

Note

In the RS-422 standard, 10 is the maximum number of connections that are allowed on one port (for a four-wire system).

Terminator

When using a multidrop connection (including a point-to-point connection), connect a terminator only to the CX on the end of the chain. Do not connect terminators to CXs in the middle of the chain. In addition, turn the terminator on the host computer ON (see the computer's manual). If a converter is being used, turn ON its terminator. The recommended converters require an external terminator to be attached. However, some converters have built-in terminators.

3.4 The Bit Structure of One Character and the Operation of the Receive Buffer

The Bit Structure of One Character

The serial interface on the CX communicates using start-stop synchronization. In start-stop synchronization, a start bit is added every time a character is transmitted. The start bit is followed by the data bits, parity bit, and stop bit. (See the figure below.)

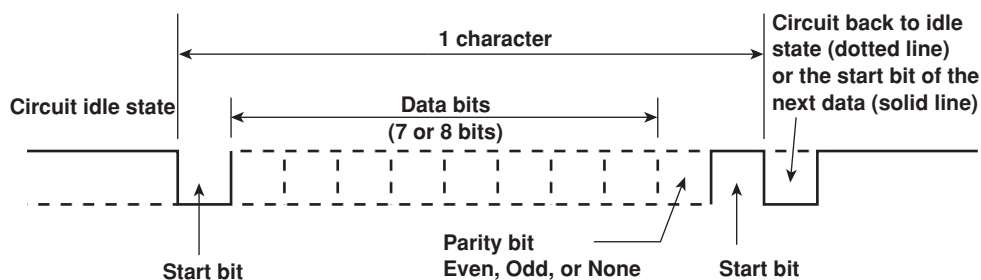

Receive Buffer and Received Data

The data received from the PC is first placed in the receive buffer of the CX. Depending on the available free space in the receive buffer, the received data is processed as shown below. When the received buffer becomes full, all of the data that overflows are discarded.

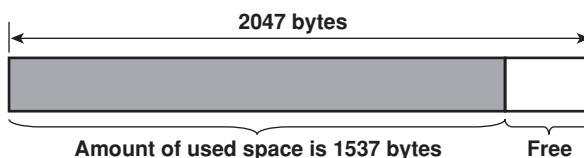

When handshaking is used, the CX stops data reception when data in the buffer cannot be processed fast enough and the amount of used space reaches 1537 bytes.

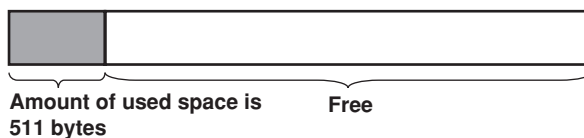

After the data reception is stopped as described above, data in the buffer continues to be passed to the internal program. When the amount of used space falls to 511 bytes, it resumes data reception.

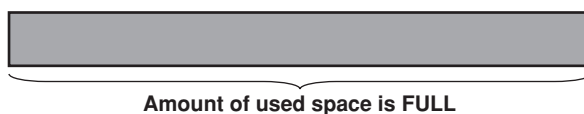

If the buffer becomes full in spite of the handshaking control, all overflow data are discarded.

3.5 Configuring the Serial Interface

Explanation

Selecting the Baud Rate

Select the baud rate from the following:
1200, 2400, 4800, 9600, 19200, and 38400

Setting the Data Length

Select the data length from the following. To output data in BINARY format, make sure to set the data length to 8 bits.
7 and 8

Selecting the Parity Check

Select the parity check from the following:
Odd, Even, and None

Selecting the Handshaking Method

Select the handshaking method from the following. This setting is valid only for the RS-232 interface.
Off:Off, XON:XON, XON:RS, and CS:RS

Selecting the Address

Select the address from the following values. This setting is valid for the RS-422/485 interface and the Modbus protocol.
1 to 32

Selecting the Protocol

Select the protocol from the following:
Normal, Modbus, Modbus-M, and Ladder

Selecting the Communication Type Used to Output the Data in the Internal Memory and Files on the External Storage Medium

- Select the communication type used to output the data in the internal memory of the CX (display, event, TLOG, manual sample, and report data) and the files on the external storage medium using output commands (ME, MI, and MO commands). Since Ethernet communications and serial communications cannot be used simultaneously, either one must be selected.
- To use the serial interface, select [Serial].

Saving the Settings

To activate the settings that have been changed in the basic setting mode, the settings must be saved. Otherwise, the settings that existed before the change are activated.

Procedure

For the basic flow of operation, see “Setup Procedure Using Operation Keys” on page ix.

1. Press the MENU key.
The setting mode (control) display appears.
2. Press the FUNC key for approximately 3 s.
The basic setting menu appears.
3. Press the [#7] (Communication) soft key ([#9] (Communication) soft key on the CX1000).
The communication function setting menu appears.
4. Press the [#1] (Ethernet, Serial) soft key ([#6] (Serial, Memory out) soft key on the CX1000).
The Communication setting display appears.

CX1000 Communication (Serial, Memory out) setting display **CX2000 Communication (Ethernet, Serial) setting display**

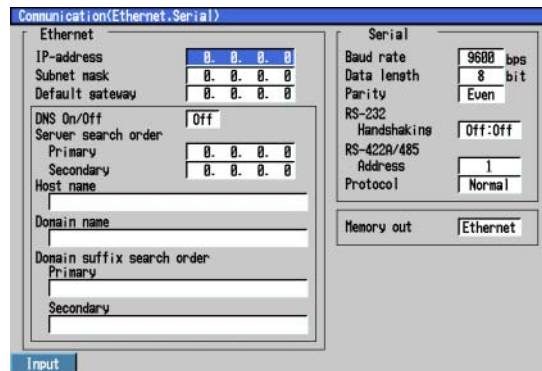
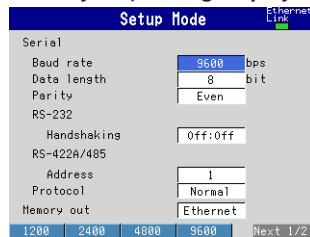

Selecting the Baud Rate

5. Use the arrow keys to move the cursor to the [Baud rate] box.

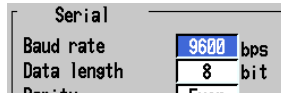

6. Press one of the soft keys from [1200] to [38400] to select the baud rate.



Selecting the Data Length

7. Use the arrow keys to move the cursor to the [Data length] box.



8. Press the [7] or [8] soft key to select the data length.



3.5 Configuring the Serial Interface

Selecting the Parity Check

9. Use the arrow keys to move the cursor to the [Parity] box.

Data length	8 bit
Parity	Even
RS-232	

10. Press one of the soft keys from [Odd] to [None] to select the parity.

Odd	Even	None
<input type="radio"/>	<input type="radio"/>	<input type="radio"/>

Selecting the Handshaking

(This setting is valid only for the RS-232 interface.)

11. Use the arrow keys to move the cursor to the [Handshaking] box.

Parity	Even
RS-232	
Handshaking	Off:Off
RS-422A/485	

12. Press one of the soft keys from [Off:Off] to [CS:RS] to select the handshaking.

Off:Off	XON:XON	XON:RS	CS:RS
<input type="radio"/>	<input type="radio"/>	<input type="radio"/>	<input type="radio"/>

Selecting the Address

(This setting is valid for the RS-422/485 interface and the Modbus protocol.)

13. Use the arrow keys to move the cursor to the [Address] box.

RS-422A/485	
Address	1
Protocol	Normal

14. Press one of the soft keys from [1] to [32] to select the address.

1	2	3	4	5	6	Next 1/6
<input type="radio"/>	<input type="radio"/>	<input type="radio"/>	<input type="radio"/>	<input type="radio"/>	<input type="radio"/>	<input type="radio"/>

Selecting the Protocol

15. Use the arrow keys to move the cursor to the [Protocol] box.

RS-422A/485	
Address	1
Protocol	Normal

16. Press one of the soft keys from [Normal] to [Ladder] to select the baud rate. The display varies depending on the options you specified at the time of purchase.

Normal	Modbus	Modbus-M
<input type="radio"/>	<input type="radio"/>	<input type="radio"/>

or

Normal	Modbus	Ladder
<input type="radio"/>	<input type="radio"/>	<input type="radio"/>

Selecting the Communication Type Used to Output the Data in the Internal Memory and Files on the External Storage Medium

17. Use the arrow keys to move the cursor to the [Memory output] box.



18. Press the [Ethernet] or [Serial] soft key. To use the serial interface, press the [Serial] soft key.

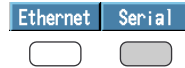

Confirming or Canceling the Settings

19. To confirm the new settings, press the DISP/ENTER key. To cancel the settings, press the ESC key.
For a detailed procedure in confirming or canceling settings, see "Setup Procedure Using Operation Keys" on page ix.

Saving the Settings

20. Press the ESC key several times to display the basic setting menu.

21. Press the [End] soft key.

A dialog box appears for you to select whether to save the settings.



22. To save the settings, select [Yes]. To not save the settings, select [No]. To return to the basic setting menu, select [Cancel]. Then, press the DISP/ENTER key.

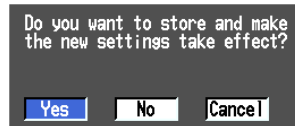

3.6 Automatic Recovery Settings

Explanation

You can select whether or not to automatically recover communications with modbus mice and temperature meters. If you select automatic recovery, you can also specify the recovery interval. You can select one of the following intervals: 1 min, 2 min, 5 min, 10 min, 20 min, 30 min, or 60 min.

Procedure

1. Press the MENU key.
The setting mode (control) display appears.
2. Press the FUNC key for approximately 3 s.
The basic setting menu appears.
3. Press the [#7] (Communication) soft key ([#9] (Communication) soft key on the CX1000).
The communication function setting menu appears.
4. Press the [#5] (AUX) soft key ([#9] (AUX) soft key on the CX1000).
Communication (AUX) setting display appears.

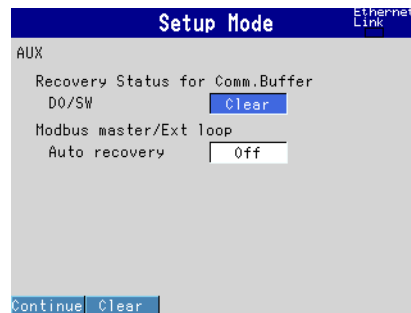

5. Use the arrow keys to move the cursor to the [Auto recovery] box.
6. Press the [On] or [Off] soft key.

Confirming or Canceling the Settings

7. To confirm the new settings, press the DISP/ENTER key. To cancel the settings, press the ESC key.
For a detailed procedure in confirming or canceling settings, see "Setup Procedure Using Operation Keys" on page ix.

Saving the Settings

8. Press the ESC key several times to display the basic setting menu.
9. Press the [End] soft key. A dialog box appears for you to select whether to save the settings.
10. To save the settings, select [Yes]. To not save the settings, select [No]. To return to the basic setting menu, select [Cancel]. Then, press the DISP/ENTER key.

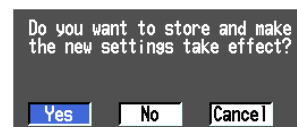

4.1 Modbus Protocol Specifications

The Modbus protocol can be used over the serial interface (RS-232 or RS-422/485).

The Modbus specifications of the CX are as follows.

Specifications	Description
Transmission media	RS-232 or RS-422/485
Control (Flow control is not available.)	RS-232: None only RS-422/485: None only
Baud rate	1200, 2400, 4800, 9600, 19200, and 38400
Start bit	Fixed to 1 bit
Stop bit	Fixed to 1 bit
Parity	Select Odd, Even, or None (no parity).
Transmission mode	RTU (Remote Terminal Unit) mode only <ul style="list-style-type: none"> • Data length 8 bits • Data interval 24 bits or less* • Error detection Uses CRC-16 * Determines message termination with a time interval equal to 3.5 characters or more.
Slave address	RS-232: 1 to 32 RS-422/485: 1 to 32

The function codes of Modbus protocol that are supported by the CX are as follows

Master Function

Function Code	Function	Operation
3	Reads the hold register (4xxxx and 4xxxxx)	The CX reads the data in the hold register of another device.
4	Reads the hold register (3xxxx and 3xxxxx)	The CX reads the data in the input register of another device.

Slave Function

Function Code	Function	Operation
3	Reads the hold register (4xxxx)	The master device can read the communication input data written using function codes 6 and 16.
4	Reads the input register (3xxxx)	The master device reads the computed, measured, control, and time data of the CX.
6	Single-write to the hold register (4xxxx)	The master device writes to the register of the CX.
8	Loopback test	The master device performs a loopback test of the CX. The CX only supports message return (test code 0x00*).
16	Writes to the hold register (4xxxx)	The master device writes to the communication input data of the CX.

* Hexadecimal "00".

4.2 Configuring the Modbus Protocol

Explanation

Selecting the Baud Rate

Select the baud rate from the following:
1200, 2400, 4800, 9600, 19200, and 38400

Selecting the Parity Check

Select the parity check from the following:
Odd, Even, and None

Selecting the Slave Address (valid when operating as a Modbus slave)

Select the address from the following values.
1 to 32

Selecting the Modbus Protocol

Select [Modbus] if you wish to communicate using the Modbus slave protocol.
Select [Modbus-M] if you wish to communicate using the Modbus master protocol.

Selecting the Communication Type Used to Output the Data in the Internal Memory and Files on the External Storage Medium

Select [Ethernet] when using output commands (ME, MI, and MO commands) to output the data in the internal memory of the CX (display, event, TLOG, manual sample, and report data) and the files on the external storage medium.
[Serial], even if selected, is invalid.

Saving the settings

To activate the settings that have been changed in the basic setting mode, the settings must be saved. Otherwise, the settings that existed before the change are activated.

Note

The data length and handshaking settings are invalid in the configuration of the Modbus protocol.

Procedure

For the basic flow of operation, see “Setup Procedure Using Operation Keys” on page ix.

1. Press the MENU key.
The setting mode (Control) display appears.
2. Press the FUNC key for approximately 3 s.
The basic setting menu appears.
3. Press the [#7] (Communication) soft key ([#9] (Communication) soft key on the CX1000).
The communication function setting menu appears.
4. Press the [#1] (Ethernet, Serial) soft key ([#6] (Serial, Memory out) soft key on the CX1000).
The Communication setting display appears.

CX1000 Communication (Serial, Memory out) setting display

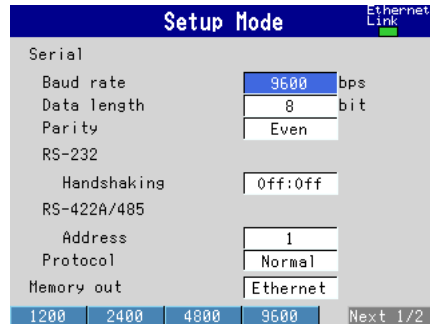

CX2000 Communication (Ethernet, Serial) setting display

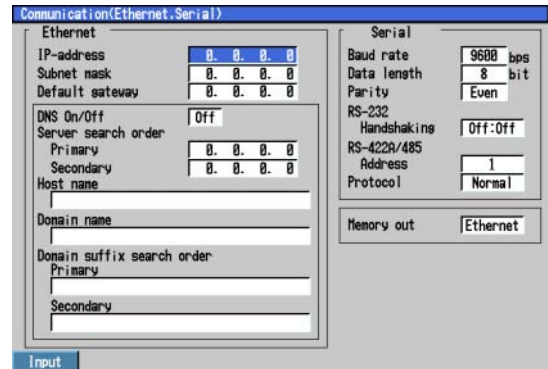

Selecting the Baud Rate

5. Use the arrow keys to move the cursor to the [Baud rate] box.

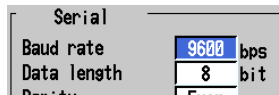

6. Press one of the soft keys from [1200] to [38400] to select the baud rate.



Selecting the Parity Check

7. Use the arrow keys to move the cursor to the [Parity] box.

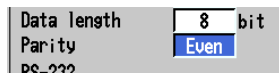

8. Press one of the soft keys from [Odd] to [None] to select the parity.



4.2 Configuring the Modbus Protocol

Selecting the Slave Address (valid when operating as a Modbus slave)

9. Use the arrow keys to move the cursor to the [Address] box.

RS-422A/485	
Address	1
Protocol	Normal

10. Press one of the soft keys from [1] to [32] to select the address.

1	2	3	4	5	6	Next 1/6
<input type="radio"/>	<input type="radio"/>	<input type="radio"/>	<input type="radio"/>	<input type="radio"/>	<input type="radio"/>	<input type="radio"/>

Selecting the Protocol

11. Use the arrow keys to move the cursor to the [Protocol] box.

RS-422A/485	
Address	1
Protocol	Normal

12. To use the Modbus slave protocol, press the [Modbus] soft key; to use the Modbus master protocol, press the [Modbus-M] soft key.

Normal	Modbus	Modbus-M	Ladder
<input type="radio"/>	<input type="radio"/>	<input type="radio"/>	<input type="radio"/>

Selecting the Communication Type Used to Output the Data in the Internal Memory and Files on the External Storage Medium

13. Use the arrow keys to move the cursor to the [Memory output] box.

Memory out	Ethernet
------------	----------

14. To use the Ethernet interface, press the [Ethernet] soft key. [Serial], even if selected, is invalid.

Ethernet	Serial
<input type="radio"/>	<input type="radio"/>

Confirming or Canceling the Settings

15. To confirm the new settings, press the DISP/ENTER key. To cancel the settings, press the ESC key.

For a detailed procedure in confirming or canceling settings, see "Setup Procedure Using Operation Keys" on page ix.

Saving the Settings

16. Press the ESC key several times to display the basic setting menu.

17. Press the [End] soft key.

A dialog box appears for you to select whether to save the settings.

End

18. To save the settings, select [Yes]. To not save the settings, select [No]. To return to the basic setting menu, select [Cancel]. Then, press the DISP/ENTER key.

Do you want to store and make the new settings take effect?		
Yes	No	Cancel

4.3 Setting the Modbus Master Function

Explanation

Selecting the Read Cycle

The cycle at which data is read from other devices. Select the read cycle from the following:

125 ms, 250 ms, 500 ms, 1 s, 2 s, 5 s, 10 s, 15 s, 20 s, and 30 s

Selecting the Timeout Time

Timeout occurs if a response is not received from the specified slave device within the time specified here (timeout time) after a command is sent from the CX. The CX repeats the operation of sending a command and waiting for a response for the number of times specified by the retrieval (see below) value. If there is no response from the slave device after the specified number of retrievals, the CX stops sending commands to the slave device.

Operation when time out occurs (Example in which the retrieval is set to 2)

↓ : Command transmission from the CX (Transmitted at the read cycle)

Yes : Response received from the specified slave device

No : No response from the specified slave device

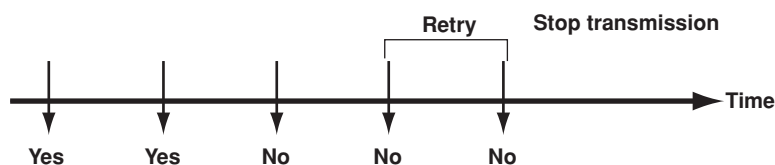
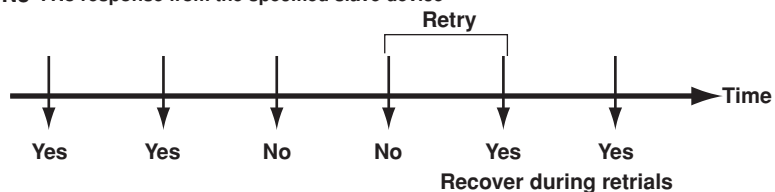

Select the timeout time from the following:

125 ms, 250 ms, 500 ms, 1 s, 5 s, 2 s, 10 s, and 1 min

Selecting the Number of Retrials

The number of times to retransmit the command when there is no response from the specified slave device. If there is no response from the slave device after the specified number of retrievals, the CX stops sending commands to the slave device.

Select the number of retrievals from the following:

Off (0 times), 1, 2, 3, 4, 5, 10, and 20

Setting the Commands

The commands are used to read the data in the register of slave devices as communication input data of the CX at the selected read cycle. Data of consecutive registers of the same data type in a slave device can be registered as a single group and read as consecutive communication input data.

• Turning On/Off the commands

Turn [On] the command registration lines to be used. Up to eight commands can be registered.

4.3 Setting the Modbus Master Function

- **Commu. Data (First, Last)**

Specify which communication input data will be assigned the data that is read from the slave device (C01 to C30).

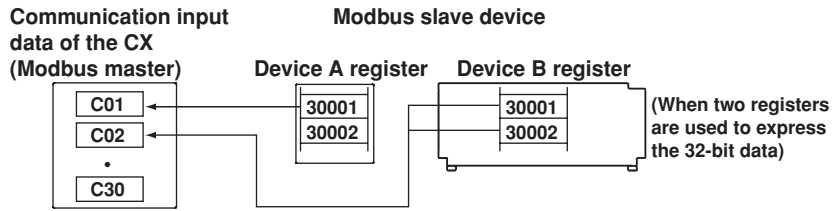

- **Address**

Specify the address of the slave device from the following:

1 to 247

- **Registers**

Specify the register number of the slave device. Since 32-bit data is assigned to two registers, specify the smaller register number (see the "Type" item below).

Input registers: 30001 to 39999, 300001 to 365535

Hold registers: 40001 to 49999, 400001 to 465535

- **Type**

Specify the type of data that is assigned to the Modbus register of the slave device (the CX reads all data as floating point data).

- **INT16**

Specify this type when a "16-bit signed integer" is assigned to the Modbus register.

Communication input data of the CX

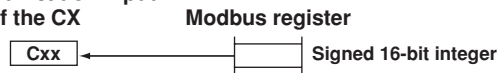

- **UINT16**

Specify this type when a "16-bit unsigned integer" is assigned to the Modbus register.

- **INT32_B**

Specify this type when a "32-bit signed integer" is assigned to the Modbus register in the order upper 16 bits followed by the lower 16 bits.

Specify the smaller register number (the higher register number in this case) in [Registers].

Communication input data of the CX

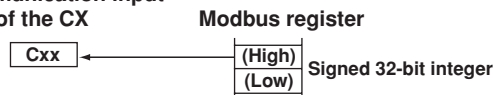

- **INT32_L**

Specify this type when a "32-bit signed integer" is assigned to the Modbus register in the order lower 16 bits followed by the upper 16 bits.

Specify the smaller register number (the lower register number in this case) in [Registers].

Communication input data of the CX

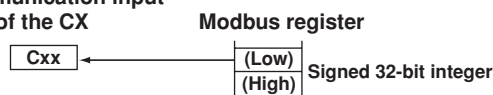

- **UINT32_B**
Specify this type when a “32-bit unsigned integer” is assigned to the Modbus register in the order upper 16 bits followed by the lower 16 bits.
Specify the smaller register number (the higher register number in this case) in [Registers].
- **UINT32_L**
Specify this type when a “32-bit unsigned integer” is assigned to the Modbus register in the order lower 16 bits followed by the upper 16 bits.
Specify the smaller register number (the lower register number in this case) in [Registers].
- **FLOAT_B**
Specify this type when a “32-bit floating-point data” is assigned to the Modbus register in the order upper 16 bits followed by the lower 16 bits.
Specify the smaller register number (the higher register number in this case) in [Registers].
- **FLOAT_L**
Specify this type when a “32-bit floating-point data” is assigned to the Modbus register in the order lower 16 bits followed by the upper 16 bits.
Specify the smaller register number (the lower register number in this case) in [Registers].

Example (Read multiple points of data using a single command)

If you enter the following settings, the values of register 30001 and register 30002 (both INT16 type) are read into C01 and C02, respectively.

Command settings		Commu.	Data	Address	Slave	Registers	Type
	First	Last					
1	On	C01	/ C02	← 1	30001		INT16

Displaying the Read Data

The data that is read can be specified by writing a computing equation using C01 through C30 on a computation channel (/M1 option). The decimal point position and the unit of the register data depend on the slave device. Correct the data that is read using a computing equation on the CX (see the example below). For information on how to use the computation channel, see the *user's manual IM 04L31A01-01E* or *IM 04L31A01-03E*.

Example (Assign communication input data C01 to computation channel 31)

When reading the INT16 data of register 30001 of a slave device at address 1 as communication input data C01, setting two digits to the right of the decimal point (multiplying by 0.01), and setting the unit to “V”

- Setting the command
First: 01, Last: 01, Address: 1, Registers: 30001, Type: INT16
- Setting the computation channel
Computing equation of CH31: C01*K01
Unit of CH31: V
Constant: K01=0.01

4.3 Setting the Modbus Master Function

Procedure

For the basic flow of operation, see “Setup Procedure Using Operation Keys” on page ix. For the procedure of entering characters and numbers, see the *user’s manual IM 04L31A01-01E* or *IM 04L31A01-03E*.

1. Press the MENU key.
The setting mode (Control) display appears.
2. Press the FUNC key for approximately 3 s.
The basic setting menu appears.
3. Press the [#7] (Communication) soft key ([#9] (Communication) soft key on the CX1000).
The communication function setting menu appears.
4. Press the [#4] (Modbus master) soft key ([#7] (Modbus master (BASIC)) soft key on the CX1000).
The Communication setting display appears.

CX1000 Communication (Modbus master (BASIC)) setting display

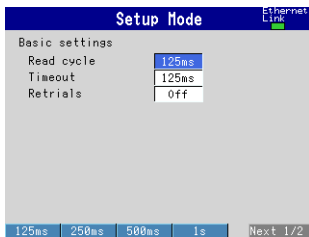

CX2000 Communication (Modbus master) setting display



Selecting the Read Cycle

5. Use the arrow keys to move the cursor to the [Read cycle] box.

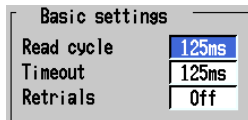

6. Press one of the soft keys from [125ms] to [10s] to select the data cycle.

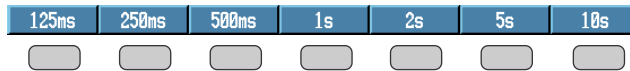

Selecting the Timeout Time

7. Use the arrow keys to move the cursor to the [Timeout] box.

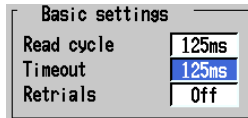

8. Press one of the soft keys from [125ms] to [1min] to select the timeout.

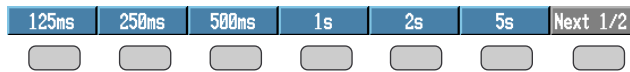

Selecting the Number of Retrials

- Use the arrow keys to move the cursor to the [Retrials] box.

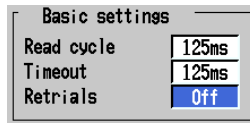

- Press one of the soft keys from [Off] to [20] to select the number of retrials.

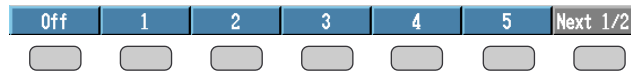

On the CX1000, confirm the settings here.

To confirm the new settings, press the DISP/ENTER key. To cancel the settings, press the ESC key.

For a detailed procedure in confirming or canceling settings, see “Setup Procedure Using Operation Keys” on page ix.

Setting Commands

• **Turning On/Off the command**

On the CX1000, if you confirmed the settings in step 10, press the ESC key to return to the communication function setting menu of step 4. Then, press the [#8 (Modbus master (COMMAND))] soft key.

- Use the arrow keys to move the cursor to the [On/Off] box.

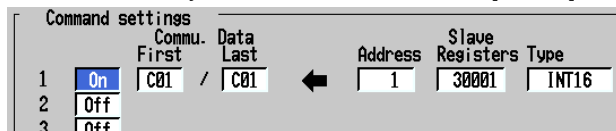

- Press the [On] or [Off] soft key.

If you selected [On] proceed to step 13; if you selected [Off] proceed to step 24.

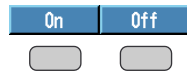

• **Setting the communication input data (First, Last) to read the data in**

- Use the arrow keys to move the cursor to the [First] box.



- Press one of the soft keys from [C01] to [C30] to select the first channel.



- Set the last channel in the similar fashion as described in step 14.



• **Setting the address of the slave device**

- Use the arrow keys to move the cursor to the [Address] box.



- Press the [Input] soft key. An entry box (numeric value input pop-up window) appears.



- Enter the address in the entry box.

- Press the DISP/ENTER key. On the CX1000, select [ENT] and then press the DISP/ENTER key.

The address that you entered appears in the [Address] box.

4.3 Setting the Modbus Master Function

- **Setting the register number of the slave device**

20. Use the arrow keys to move the cursor to the [Registers] box.



21. Press the [Input] soft key. An entry box appears.



22. Enter the register number in the entry box.

23. Press the DISP/ENTER key. On the CX1000, select [ENT] and then press the DISP/ENTER key.

The register number that you entered appears in the [Registers] box.

- **Setting the data type assigned to the register of the slave device**

24. Use the arrow keys to move the cursor to the [Type] box.



25. Press one of the soft keys from [INT16] to [FLOAT_L] to select the baud rate.



Confirming or Canceling the Settings

26. To confirm the new settings, press the DISP/ENTER key. To cancel the settings, press the ESC key.

For a detailed procedure in confirming or canceling settings, see "Setup Procedure Using Operation Keys" on page ix.

Saving the Settings

27. Press the ESC key several times to display the basic setting menu.

28. Press the [End] soft key. A dialog box appears for you to select whether to save the settings.



29. To save the settings, select [Yes]. To not save the settings, select [No]. To return to the basic setting menu, select [Cancel]. Then, press the DISP/ENTER key.

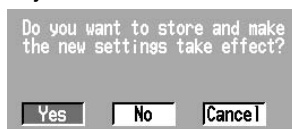

4.4 Checking the Operation Status of the Modbus Master Function

Explanation

”MODBUS STATUS” Display

You can check the operation status of the Modbus master function on the “MODBUS STATUS” screen.

CX2000 screen example

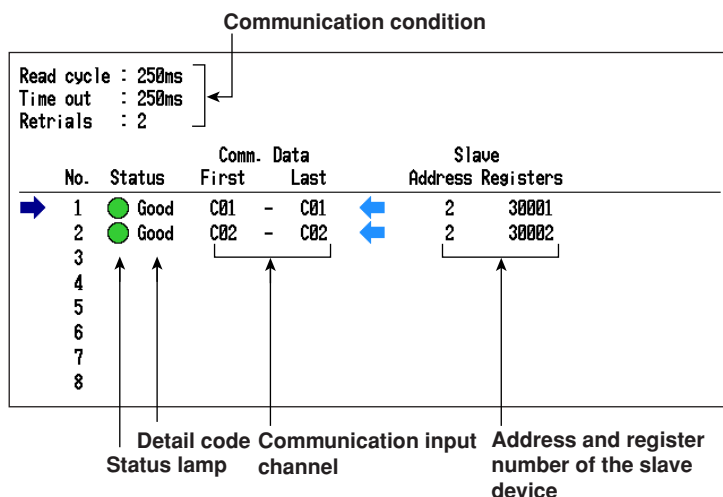

Communication Status

The communication status is displayed using the status lamp and the detail code.

Status Lamp	Detail Code	Meaning
Green	GOOD	Communication is operating normally.
Yellow		Retrying.
Red		Communications stopped since communications did not recover after the specified number of retrials.
	NONE	No response from the slave device.
	FUNC	The slave device cannot execute the command from the CX.
	REGI	The slave device does not have the specified register.
	ERR	There is an error in the response data from the slave device.
	(Space)	The detail code is not displayed until the status is confirmed when communication is started.

Resuming Command Transmission

You can use the front panel keys to resume command transmission to the slave device to which command transmission is stopped.

Data during Retrial and When Communication Is Stopped

The communication input data is held at the previous value during retrial. When command transmission is stopped, communication input data becomes error data. In this case, computation channels display “+*****.”

Data Dropout

Data drop occurs when the commands from 1 to 8 do not complete within the read cycle (see appendix 5). When a data dropout occurs, the communication input data is held at the previous value. Take measures such as making the read cycle longer or reducing the number of commands.

4.4 Checking the Operation Status of the Modbus Master Function

Procedure

Displaying the “Modbus Master Status” Screen

1. Press the FUNC key. The FUNC menu appears. The structure of the FUNC menu varies depending on the basic settings and options.
2. Press the [Modbus master] soft key. The MODBUS STATUS screen appears.



Data Dropout

When a data dropout occurs, the message “Data dropout” is displayed on the MODBUS STATUS screen.



Press an arrow key to clear the message.

Resuming Command Transmission to the Slave Device to Which Command Transmission Is Stopped due to Timeout

1. Using the up and down arrow keys, select the command corresponding to the slave device to which transmission will be resumed.

CX2000 screen example

No.	Status	Comm. Data		Slave Address Registers	
		First	Last		
1	● Good	C01	- C01	←	2 30001
2	● Good	C02	- C02	←	2 30002
→ 3	● None	C03	- C03	←	3 30001
4					
5					

A message “Push [right arrow] key to refresh” appears.



2. Press the right arrow key to start command transmission to the specified slave device.

4.5 Communications as a Modbus Slave

This section explains the command messages used when setting the CX to Modbus slave and communicating with a Modbus master device. By sending a command message from a Modbus master device, the input registers of the CX can be read and the hold registers can be read or written.

Command Message Construction

Below is the construction of command messages sent from a Modbus master device to the CX.

Slave Address	Function Code	Data	Error Check
---------------	---------------	------	-------------

Slave Address

Specify the address of the Modbus slave device to communicate with. The slave address on the CX is set in the range of 1 to 32 (selected in the serial interface settings). The command messages from a master device are received by all the Modbus slave devices that are connected. However, only the slave device with the matching address reads the message and returns data.

Function Code

Specifies the command (function code) from the Modbus master.

Data

Specifies parameters such as the internal register (D register) number and quantity according to the function code.

Error Check

Error check is performed using cyclic redundancy check (CRC-16).

Specifying the Register Number

Following the function code, data that is required by the Modbus slave device in executing the function is transmitted. The data includes the register number to which a read or write operation is to be executed.

The following table shows the assignment of the reference number to each register on the CX.

Item	Reference Number
Input register	3xxxx
Hold register	4xxxx

If the Modbus master device is to specify the input register or the hold register using a command message, the register is specified using a relative number with respect to the reference number. If the reference number of the item to be specified is 4xxxx, the relative number with respect to this reference number is the number obtained by subtracting 40001 from 4xxxx. For example, if the reference number of the input register to be specified is 30100, the relative number is 99.

Reference Number	Relative Number
30100	30100-30001 = 99

Note

For information on the contents of the input registers and hold registers, see appendix 6.

Broadcast Request

Broadcast request is a function used to write the same data collectively to the hold registers of all the Modbus slave devices connected to the Modbus master device.

- Broadcast request is achieved by setting the slave address number of a command message to “00.”
- The command message that specifies this address functions regardless of the slave address.
- The broadcast request can be used only on function codes 6 (write to single hold register) and 16 (write to multiple hold registers).
- The CX does not return a response.

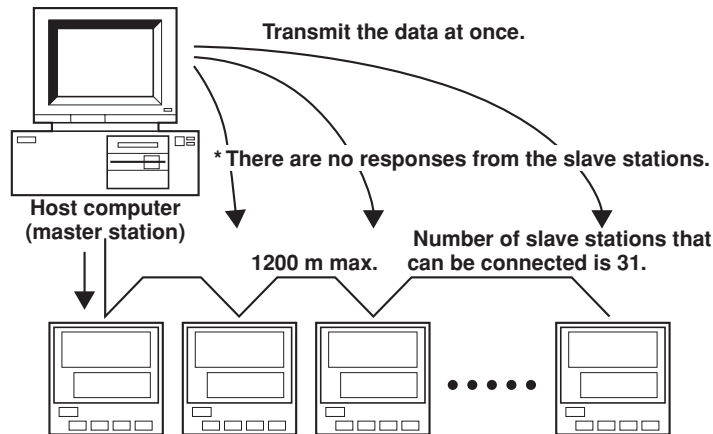

Function Code

Modbus master devices use function codes to make the Modbus slave devices execute the commands. The Modbus slave function of the CX supports the following function codes.

Code	Command
3	Read the hold register (4xxxx)
4	Read the input register (3xxxx)
6	Write to single hold register (4xxxx)
8	Loopback test (However, the CX only returns test code 0x00.)
16	Write to multiple hold registers (4xxxx)

- Writing is not performed on read-only registers and forbidden registers
- Broadcasting request is allowed on function codes 6 and 16.

Read Multiple Hold Registers (Function Code 3)/Read Multiple Input Registers (Function Code 4)

Reads the specified number of points consecutively from the registers from the specified register number. The maximum number of points that can be read at once is 125.

• Command message

Slave address	Function code	Register start number (High)	Register start number (Low)	Number of registers (High)	Number of registers (Low)	Error check
---------------	---------------	------------------------------	-----------------------------	----------------------------	---------------------------	-------------

• Response

Slave address	Function code	Byte counter	Register content (High)	Register content (Low)	••••	Register content (High)	Register content (Low)	Error check
---------------	---------------	--------------	-------------------------	------------------------	------	-------------------------	------------------------	-------------

Write to Multiple Hold Registers (Function Code 16)

Writes the specified number of points of data consecutively to the registers from the specified register number. The maximum number of points that can be written at once is 100. Broadcast request (setting the slave address to 00) is possible.

• Command message

Slave address	Function code	Register start number (High)	Register start number (Low)	Number of registers (High)	Number of registers (Low)	Byte counter	Data (High)	Data (Low)	••••	Error check
---------------	---------------	------------------------------	-----------------------------	----------------------------	---------------------------	--------------	-------------	------------	------	-------------

• Response

Slave address	Function code	Register start number (High)	Register start number (Low)	Number of registers (High)	Number of registers (Low)	Error check
---------------	---------------	------------------------------	-----------------------------	----------------------------	---------------------------	-------------

Write to Single Hold Register (Function Code 6)

Writes the data to the specified number. Only a single data point is written at once. Broadcast request (setting the slave address to 00) is possible.

• Command message

Slave address	Function code	Number of registers (High)	Number of registers (Low)	Written data (High)	Written data (Low)	Error check
---------------	---------------	----------------------------	---------------------------	---------------------	--------------------	-------------

• Response

Slave address	Function code	Number of registers (High)	Number of registers (Low)	Written data (High)	Written data (Low)	Error check
---------------	---------------	----------------------------	---------------------------	---------------------	--------------------	-------------

Loopback Test (Function Code 8)

This command is used to check the connection. An arbitrary value can be selected for the transmitted data, and the same value is returned as a response.

• Command message

Slave address	Function code	00 (High)	00 (Low)	Transmitted data (High)	Transmitted data (Low)	Error check
---------------	---------------	-----------	----------	-------------------------	------------------------	-------------

• Response

Slave address	Function code	00 (High)	00 (Low)	Same as transmitted data (High)	Same as transmitted data (Low)	Error check
---------------	---------------	-----------	----------	---------------------------------	--------------------------------	-------------

4.6 Modbus Slave Error Responses

Message Format for Errors

If an invalid command other than those determined as communication error is found in the message, the CX does not process the message and returns a message in the following format.

Slave Address	Function Code	Error code	Error Check
---------------	---------------	------------	-------------

Response Error Codes

The meaning of the error codes in error messages is shown below.

Error Code	Meaning	Reason
01	Function code error	The function code does not exist.
02	Register address error	Address outside the range was specified.
03	Register number error	Number outside the range was specified.
07	Not executable	Data to be written is outside the range, etc. The process specified by the function code cannot be executed due to reasons other than error codes 01 to 03.

When Responses Are Not Received

If there is no response when a message is sent, the possible reasons are as follows:

- Transmission error is detected (overrun, framing, parity, or CRC-16 error).
- The slave address of the command message is incorrect.
- The spacing of the data constructing the message is greater than 1 s.
- The command message is a broadcast request (slave address set to 00).

Provide a timeout procedure on the communication function or communication program of the Modbus master to handle the above situation.

5.1 Ladder Communication Protocol Specifications

The ladder communication protocol can be used over the serial interface (RS-232 or RS-422/485).

The ladder communication specifications of the CX are as follows.

Specifications	Description
Transmission media	RS-232 or RS-422/485
Control (Flow control is not available)	RS-232: None only RS-422/485: None only
Baud rate	1200, 2400, 4800, 9600, 19200, and 38400
Start bit	Fixed to 1 bit
Stop bit	Fixed to 1 bit
Parity	Select Odd, Even, or None (no parity).
Communication address	1 to 32

5.2 Setting the Ladder Communication Protocol

Explanation

The CX supports the ladder communication protocol. Multiple CXs can be connected to Programmable Logic Controllers (PLCs) that are capable of ladder communications.

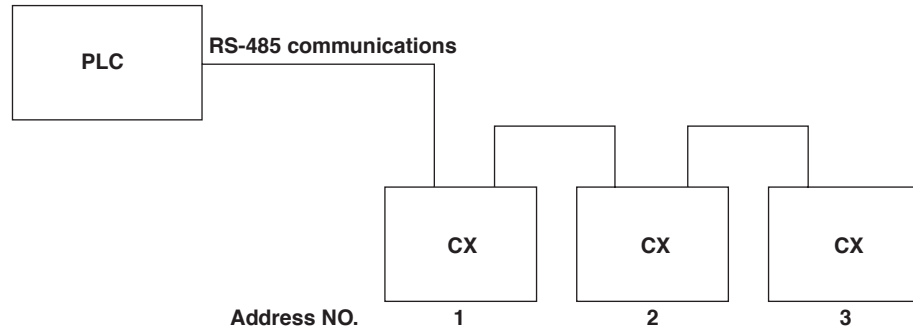

To support ladder communications on the CX, the following parameters must be set on the serial interface. Set the parameter values to match those of the PLC. The description of the procedures of setting the parameters starts on the next page.

Baud Rate

Below are the selectable baud rates.
1200, 2400, 4800, 9600, 19200, and 38400

Parity Check

Select the parity check from the following:
Odd, Even, and None

Communication Address

Select an arbitrary address in the range of 1 to 32. The address of the CX connected to a single PLC must be unique.

Protocol

Select [Ladder] if you wish to communicate using the ladder communication protocol.

Selecting the Communication Type Used to Output the Data in the Internal Memory and Files on the External Storage Medium

Select [Ethernet] when using output commands (ME, MI, and MO commands) to output the data in the internal memory of the CX (display, event, TLOG, manual sample, and report data) and the files on the external storage medium.
[Serial], even if selected, is invalid.

Note

The data length and handshaking settings are invalid in the configuration of the ladder communication protocol.

Procedure

For the basic flow of operation, see “Setup Procedure Using Operation Keys” on page ix.

1. Press the MENU key.
The setting mode (Control) display appears.
2. Press the FUNC key for approximately 3 s.
The basic setting menu appears.
3. Press the [#7] (Communication) soft key ([#9] (Communication) soft key on the CX1000).
The communication function setting menu appears.
4. Press the [#1] (Ethernet, Serial) soft key ([#6] (Serial, Memory out) soft key on the CX1000).
The communication setting display appears.

CX1000 Communication (Serial, Memory out) setting display

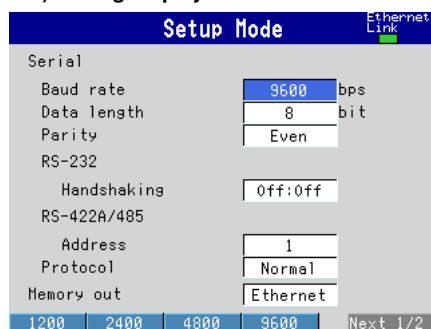

CX2000 Communication (Ethernet, Serial) setting display

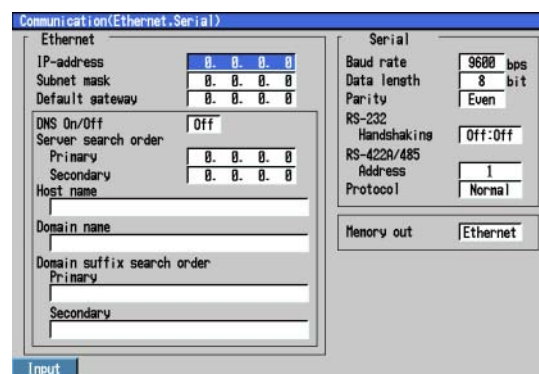

Selecting the Baud Rate

5. Use the arrow keys to move the cursor to the [Baud rate] box.



6. Press one of the soft keys from [1200] to [38400] to select the baud rate.



Selecting the Parity Check

7. Use the arrow keys to move the cursor to the [Parity] box.



8. Press one of the soft keys from [Odd] to [None] to select the parity.



Selecting the Address

9. Use the arrow keys to move the cursor to the [Address] box.

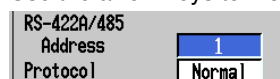

5.2 Setting the Ladder Communication Protocol

10. Press one of the soft keys from [1] to [32] to select the address.
This value is the station number of the ladder communication commands.



Selecting the Protocol

11. Use the arrow keys to move the cursor to the [Protocol] box.

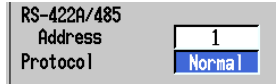

12. Press the [Ladder] soft key.

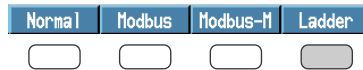

Selecting the Communication Type Used to Output the Data in the Internal Memory and Files on the External Storage Medium

13. Use the arrow keys to move the cursor to the [Memory output] box.



14. To use the Ethernet interface, press the [Ethernet] soft key.
[Serial], even if selected, is invalid.

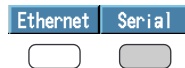

Confirming or Canceling the Settings

15. To confirm the new settings, press the DISP/ENTER key. To cancel the settings, press the ESC key.
For a detailed procedure in confirming or canceling settings, see "Setup Procedure Using Operation Keys" on page ix.

Saving the Settings

16. Press the ESC key several times to display the basic setting menu.

17. Press the [End] soft key.
A dialog box appears for you to select whether to save the settings.



18. To save the settings, select [Yes]. To not save the settings, select [No]. To return to the basic setting menu, select [Cancel]. Then, press the DISP/ENTER key.

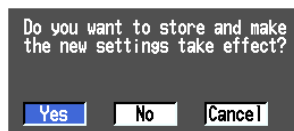

Note

To activate the settings that have been changed in the basic setting mode, the settings must be saved. Otherwise, the settings that existed before the change are activated.

5.3 Communications with PLCs

When performing ladder communications, make sure the PLC (host) first sends a command to the CX. When the CX receives a command from a PLC, the CX executes the specified operation, provided that no errors are present in the received command, and returns a response to the PLC. If an error is present in the command, the CX returns an error code corresponding to the error type to the PLC.

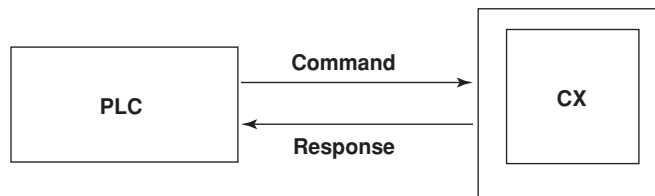

The PLCs that the CX can communicate with are those that support the ladder communication protocol.

Connectable PLCs are indicated below.

Distributor	Product Name	Requirements
YOKOGAWA	FA500	With communication module (RZ91-0N)
	FA-M3	With communication module (F3RZ91-0N)
Mitsubishi Electric Corporation	MELSEC-A Series and others	With computer link module
Others	PLCs that can use the non-procedural mode	With module for RS-232 or RS-422/485

For information on the PLCs, contact the respective distributor. For details, refer to the instruction manual for the PLC to be connected.

Command Construction

The figure below illustrates the construction of the commands that PLCs transmit.

Number of Bytes	Number of BCD Digits	Command Element
1	2	Station number
1	2	CPU number (01)
2	4	D register number
1	1	0
	1	5th digit
1	1	R/W
	1	+/-
2	4	Read and write data
1	2	CR
1	2	LF

- **Station number (1-32)**

The number used by the PLC to identify the communication destination. The serial interface address of the CX to which commands are sent is specified here.

- **CPU number**

Fixed to "01".

- **D register number**

The D register number is specified using a 4-digit BCD value excluding the "D".

Note

In ladder communications, the D register number is specified using BCD codes. BCD is a method of using 4 bits to represent the decimal digits 0 through 9. For example, the value 99 expressed using 1-byte BCD code is "10011001" (not "01100011").

5.3 Communications with PLCs

- **0**
This position is fixed to 0.
- **5th digit**
The most significant digit when using 5-digit notation.
- **R/W**
Specifies whether the command is a write command or a read command.
0: Read
1: Write
- **+/-**
0: Positive data (+)
1: Negative data (-)
- **Read and write data**
Specifies the number of data points to be read when reading.
Specifies the data to be written using 4-digit BCD excluding the decimal point when writing.
- **CR, LF**
Control code indicating the end of a command.

Response

The following figure illustrates the construction of responses that the CX returns.

Response against a read command

Number of Bytes	Number of BCD Digits	Command Element
1	2	Station number
1	2	CPU number (01)
2	4	D register number
1	1	0
	1	5th digit
1	1	0
	1	+/-
2	4	Data 1
1	1	0
	1	5th digit
1	1	0
	1	+/-
2	4	Data 2
:	:	:
1	1	0
	1	5th digit
1	1	0
	1	+/-
2	4	Data n
1	2	CR(0D)
1	2	LF(0A)

Example

Command for reading the 3rd channel (D register 0003) of the communication register data of station number 01

010100030000000010D0A

Response when the measured value of 200 (BCD code) is returned against the command above

01010003000002000D0A

Response against a write command

Number of Bytes	Number of BCD Digits	Command Element
1	2	Station number
1	2	CPU number (01)
2	4	D register number
1	1	0
	1	5th digit
1	1	1
	1	+/-
2	4	dddd
1	2	CR(0D)
1	2	LF(0A)

Example

Command for writing data 200 to the 1st target setpoint (D register 1101) of CX station number 01

```
01011101001002000D0A
```

Response that returns the same data value 200 (BCD code) as a result of a successful command execution

```
01011101001002000D0A
```

Response When Errors Occur

The table below shows the error responses that the PLC receives when errors occur.

Error Status	PLC Transmission data (Command)	PLC Reception data (Response When an Error Occurs)
When a non-existing parameter number is transmitted	0101 0000 0000 0001 0D0A 0000: Wrong parameter number	0101 0000 0000 FFFF 0D0A ("FFFF" is returned.)
When a parameter other than the station number is transmitted using characters other than BCD code.	0101 0123 0000 000B 0D0A 0101 0123 000B 0000 0D0A 0101 0123 0B00 0000 0D0A 0101 012B 0000 0000 0D0A	0101 FFFF FFFF FFFF 0D0A
When a parameter other than the station number is transmitted using the LF code (0A).	0101 0123 0000 000A 0D0A 0101 0123 000A 0000 0D0A 0101 0123 0A00 0000 0D0A 0101 010A 0000 0000 0D0A	No response.
When the station number is different from the device's station number.	01 03 0123 0000 0000 0D0A 0001 0123 0000 0000 0D0A 3301 0123 0000 0000 0D0A	No response.
When the number of registers to be read is outside the 1 to 64 range.	0101 0125 0000 0068 0D0A	0101 0125 0000 FFFF 0D0A
When writing fails		0101 0123 0011 F050 0D0A FXXX: Error code (where XXX is the error code number (see appendix 7)).
When the command length is not correct (command length is 10 bytes including CR and LF).	0101 0123 0000 00 0D0A 0101 0123 00 0000 0D0A 0101 0 0000 0000 0D0A	No response.
When a timeout occurs during transmission (timeout is 5 s).		No response.
When the transmission buffer overflows (buffer overflow is 200 bytes or more).		No response.
When a communication framing error or parity error occurs.		No response.

Note

If an attempt is made to read a parameter that does not exist in the D register list, the CX returns "0" instead of an error.

5.4 Communication Program for FA-M3

Below is a program example for communications between the CX and the FA-M3 Sequencer by YOKOGAWA. The FA-M3 uses the ladder communication module (F3RZ81-0N, F3RZ91-0N).

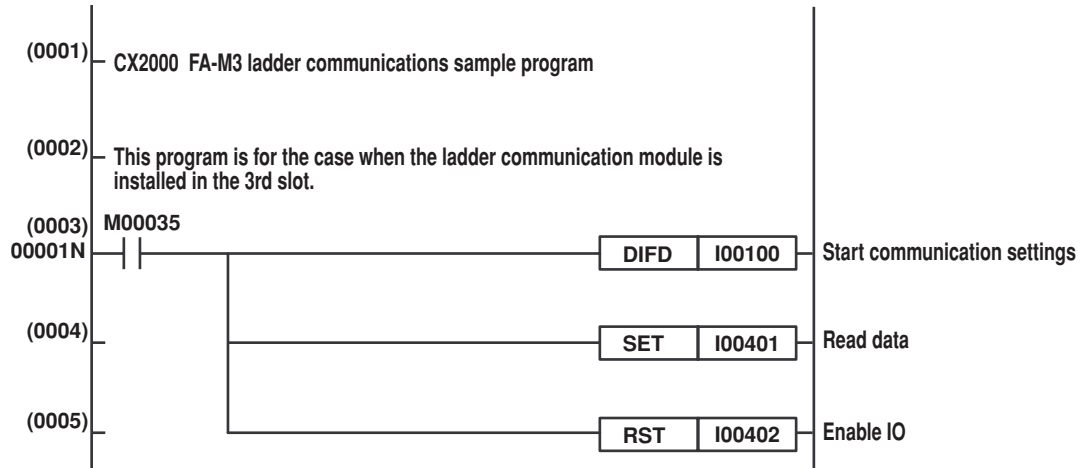

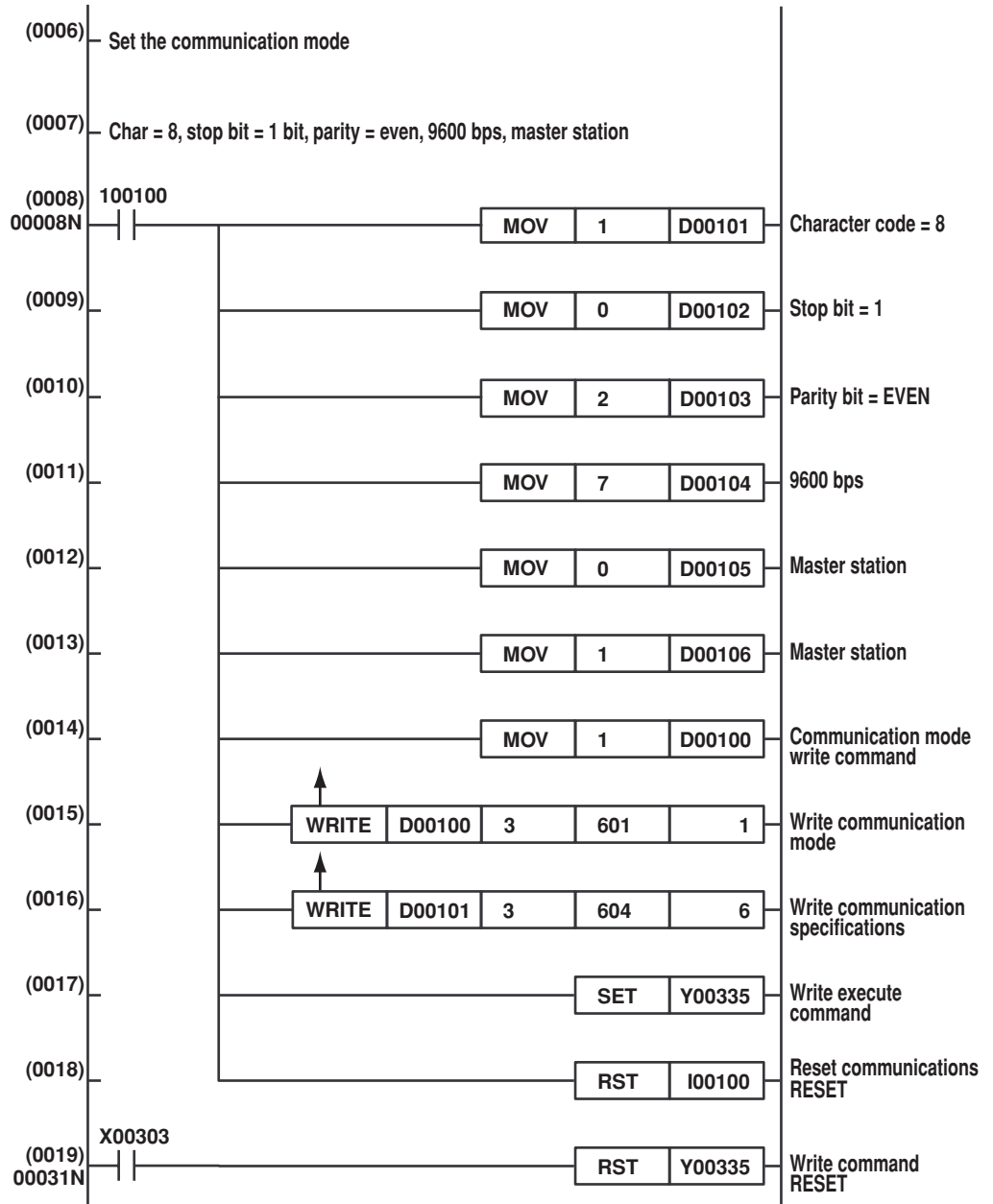

5.4 Communication Program for FA-M3

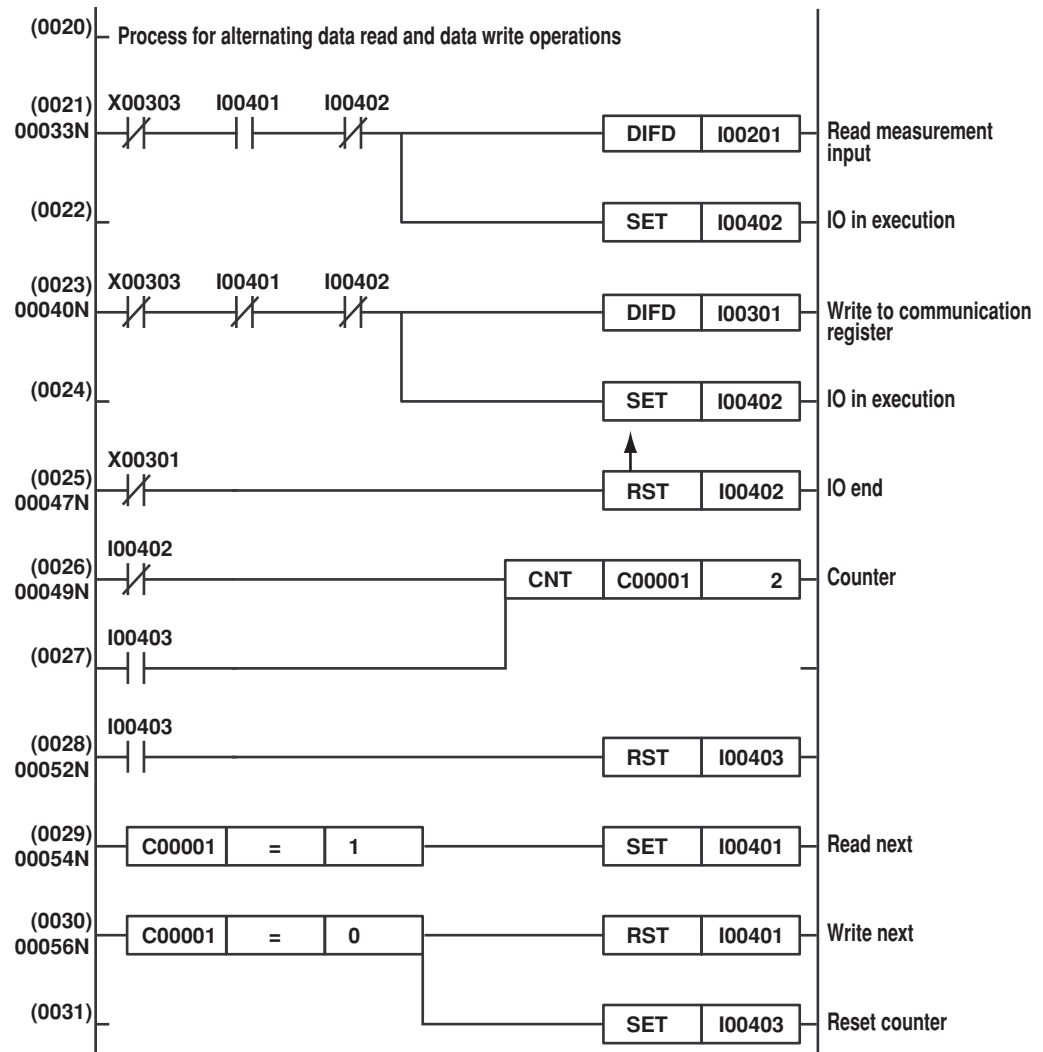

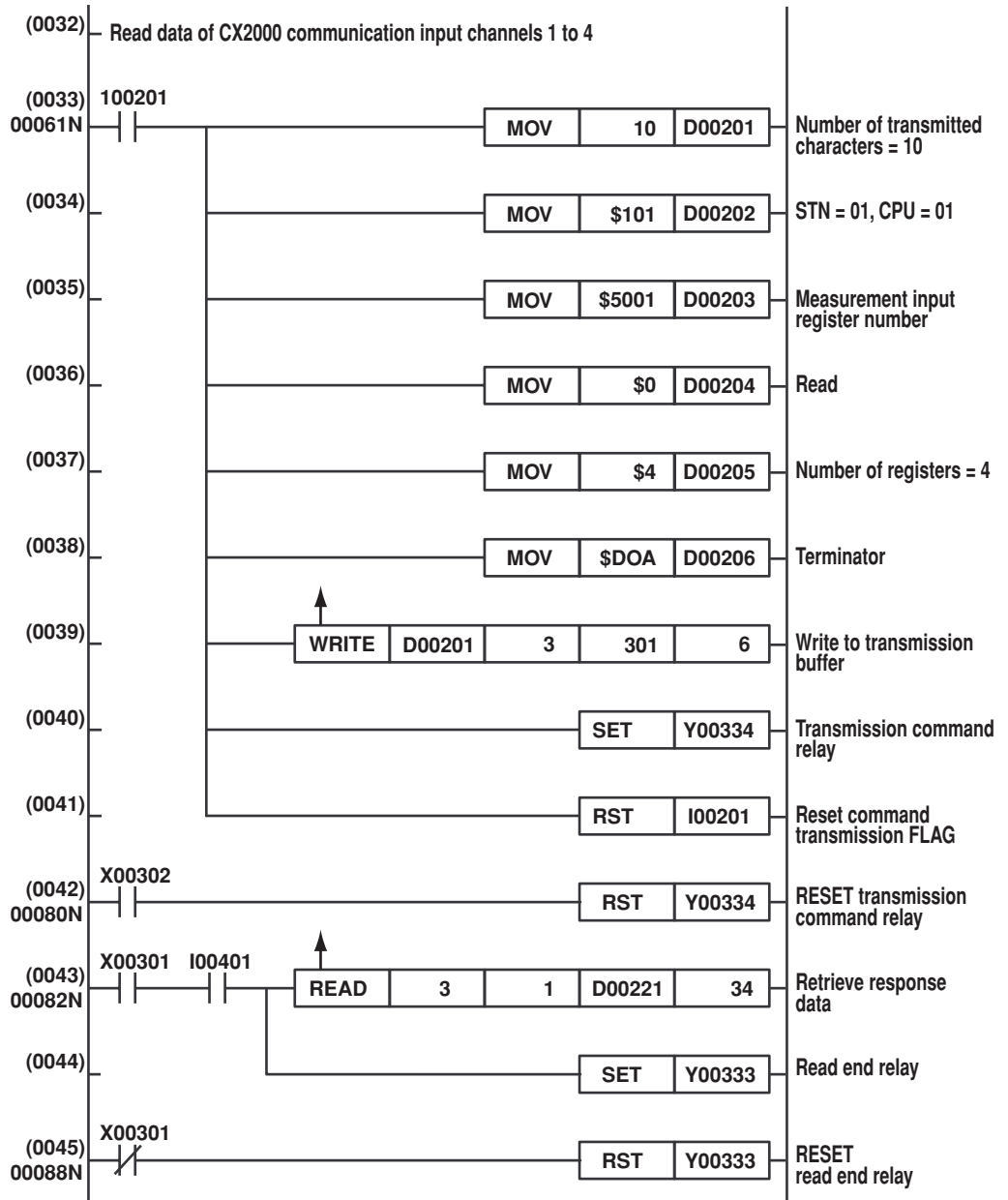

5.4 Communication Program for FA-M3

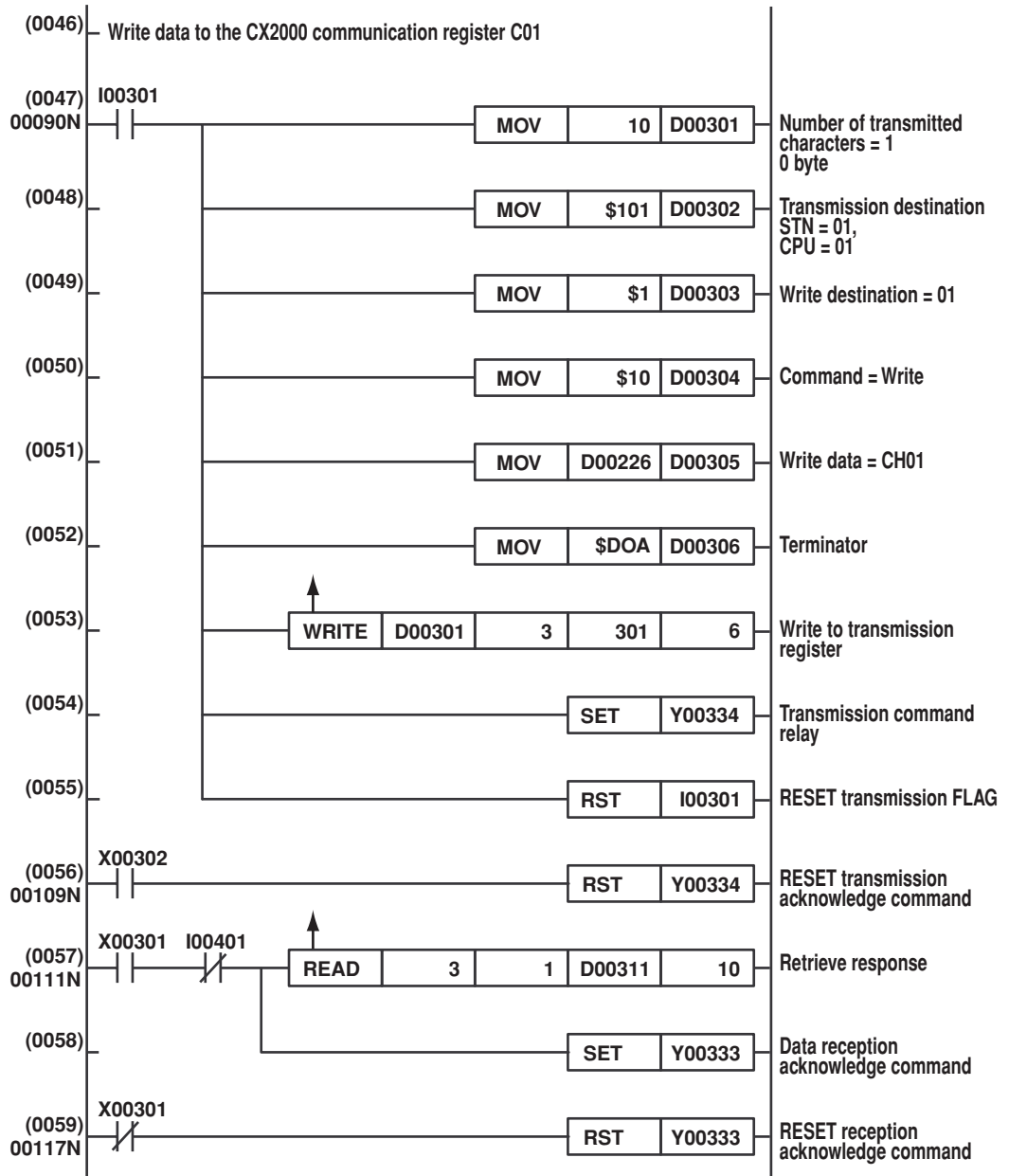

5.5 Communication Program for MELSEC

Below is a program example for communications between the CX and the MELSEC Q02HCPU sequencer made by Mitsubishi Electric Corporation.

Preparations before Communications

Devices Used

This sample program assumes that the QJ71C24 computer module (communication module) is installed into slot 2 of the Q02HCPU.

Connection

Connect the RS422 terminal of the QJ71C24 computer link unit to the CX according to the figure below.

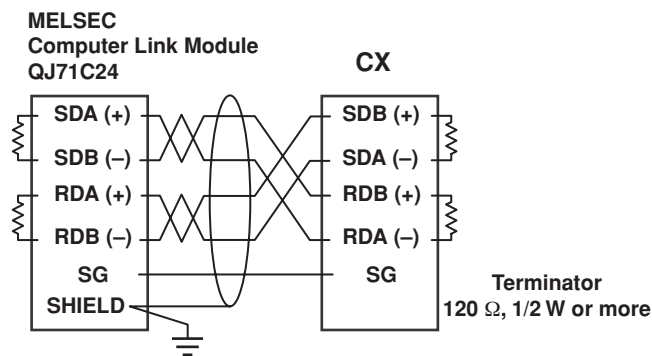

Use the PC software program for MELSEC and set the I/O assignments and their switch settings as follows:

I/O Assignments

Slot	Type	Model	Number of Points
CPU	CPU		
2(*-2)	Intelligent	QJ71C24	32

I/O Assignment Switch Setting

Slot	Type	Model	Switch 1	Switch 2	Switch 3	Switch 4	Switch 5
CPU	CPU						
2(*-2)	Intelligent	QJ71C24	0000	0000	0582	0006	0000

Program Example

- Transmission interval processing

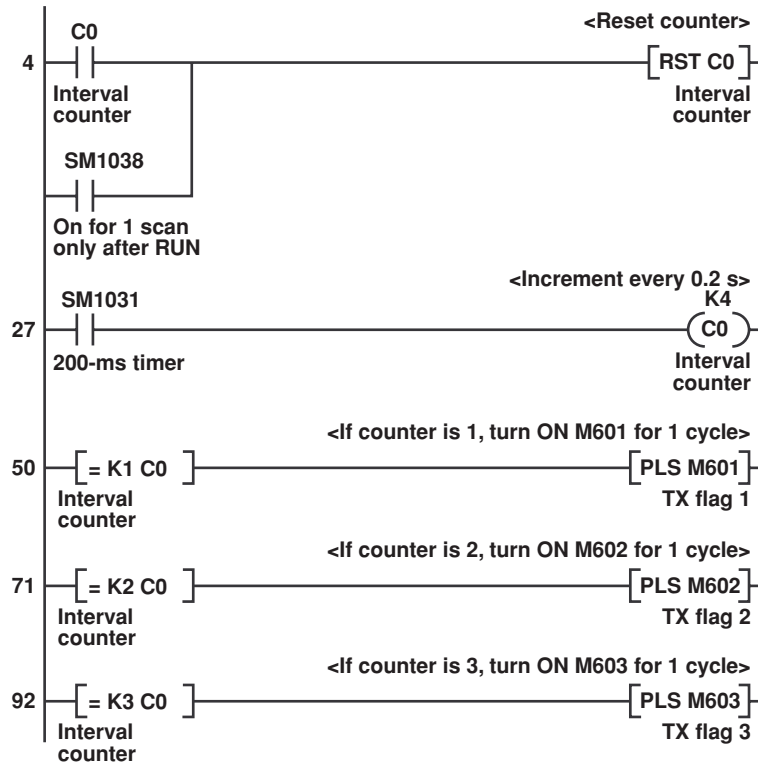

- Read command transmission processing: If M601 is ON, send a command to lead CH1 to 4.

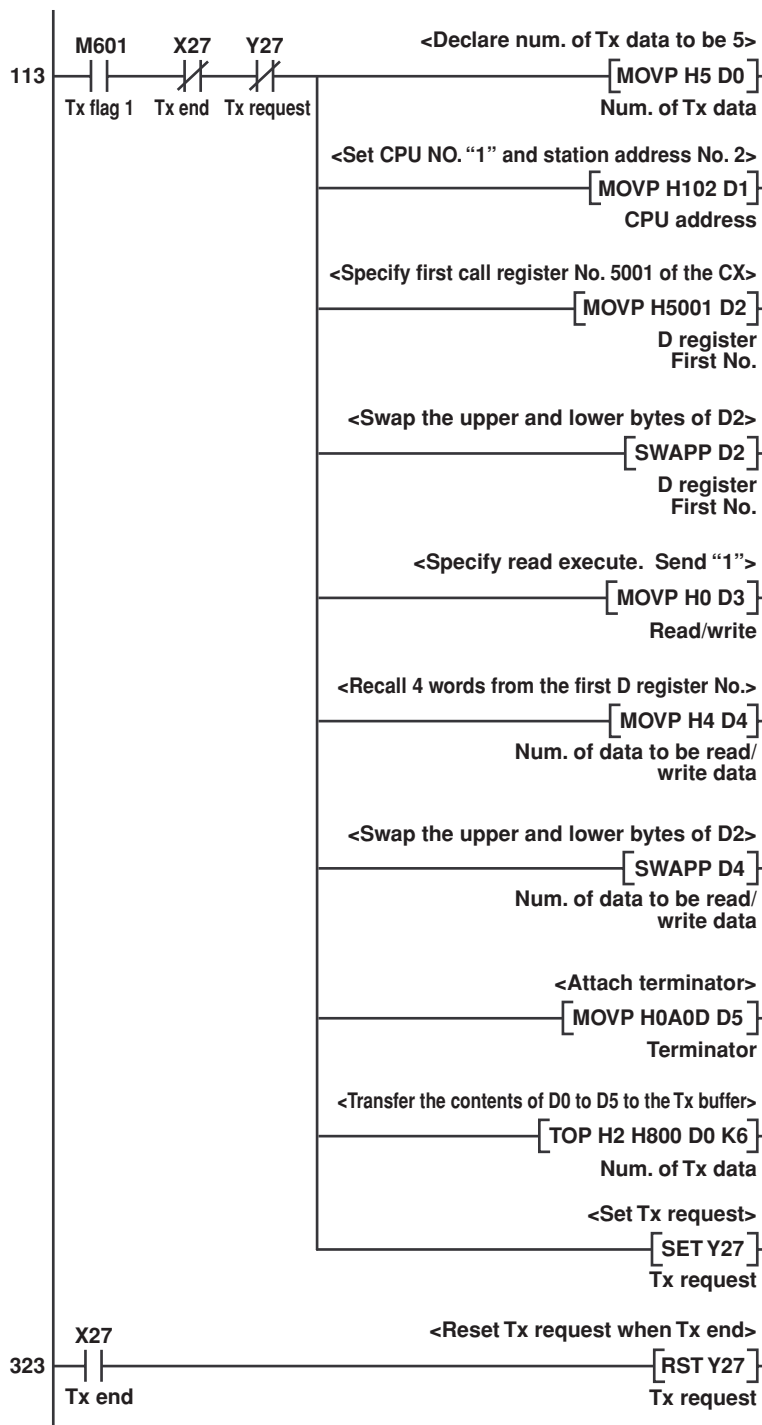

• Reception processing: Receive data of CH1 to 4.

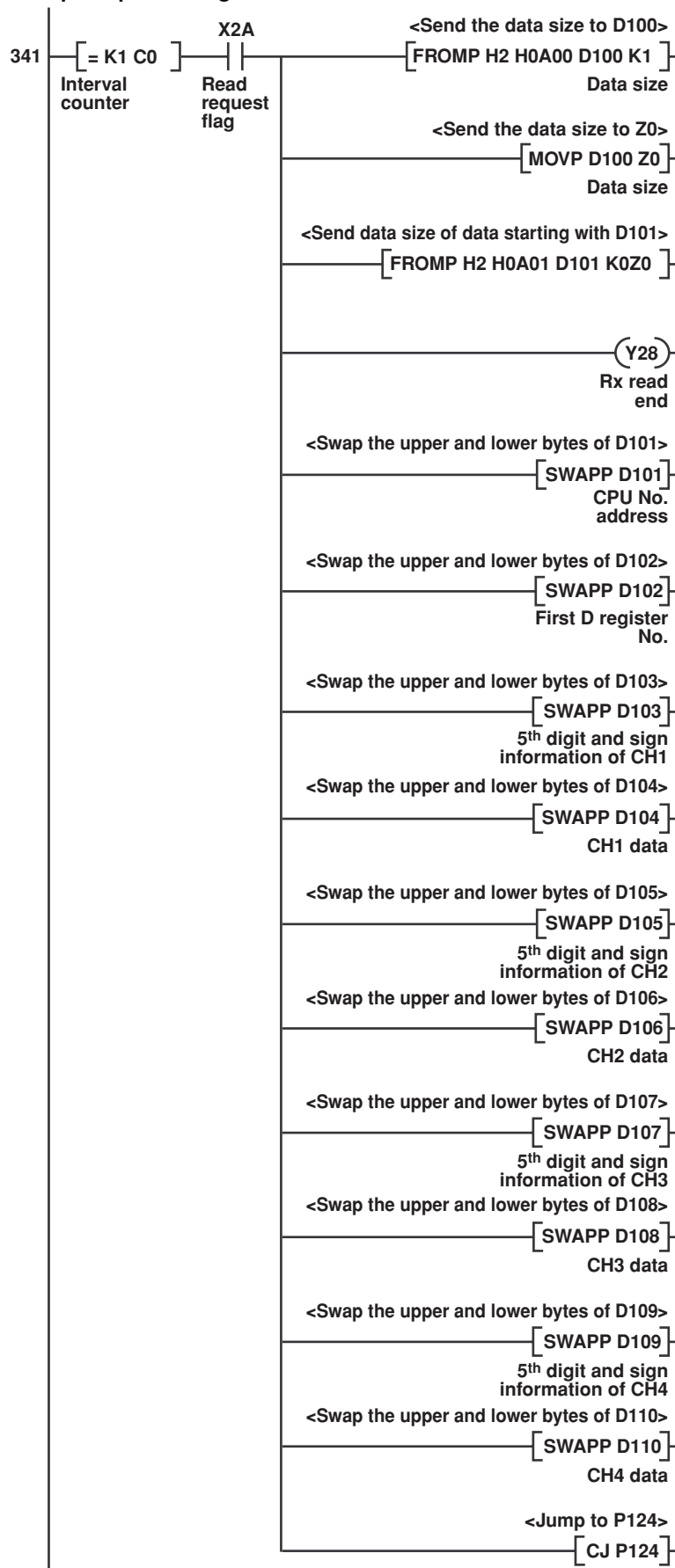

- Write processing: If M602 is set, write the CH1 data to communication register C1.

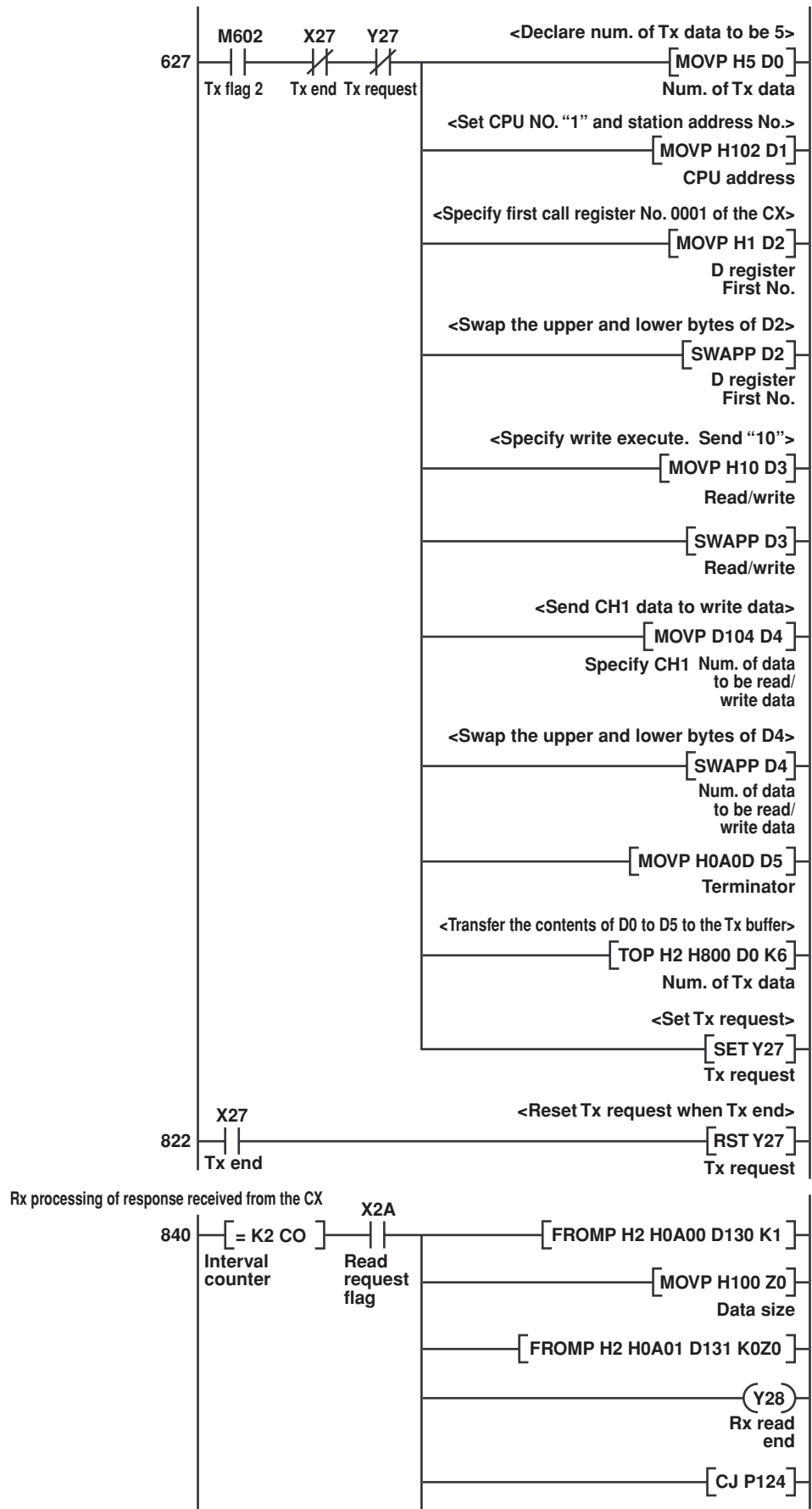

5.5 Communication Program for MELSEC

- Read command transmission processing: If M603 is ON, send a command to lead CH5 to 8.

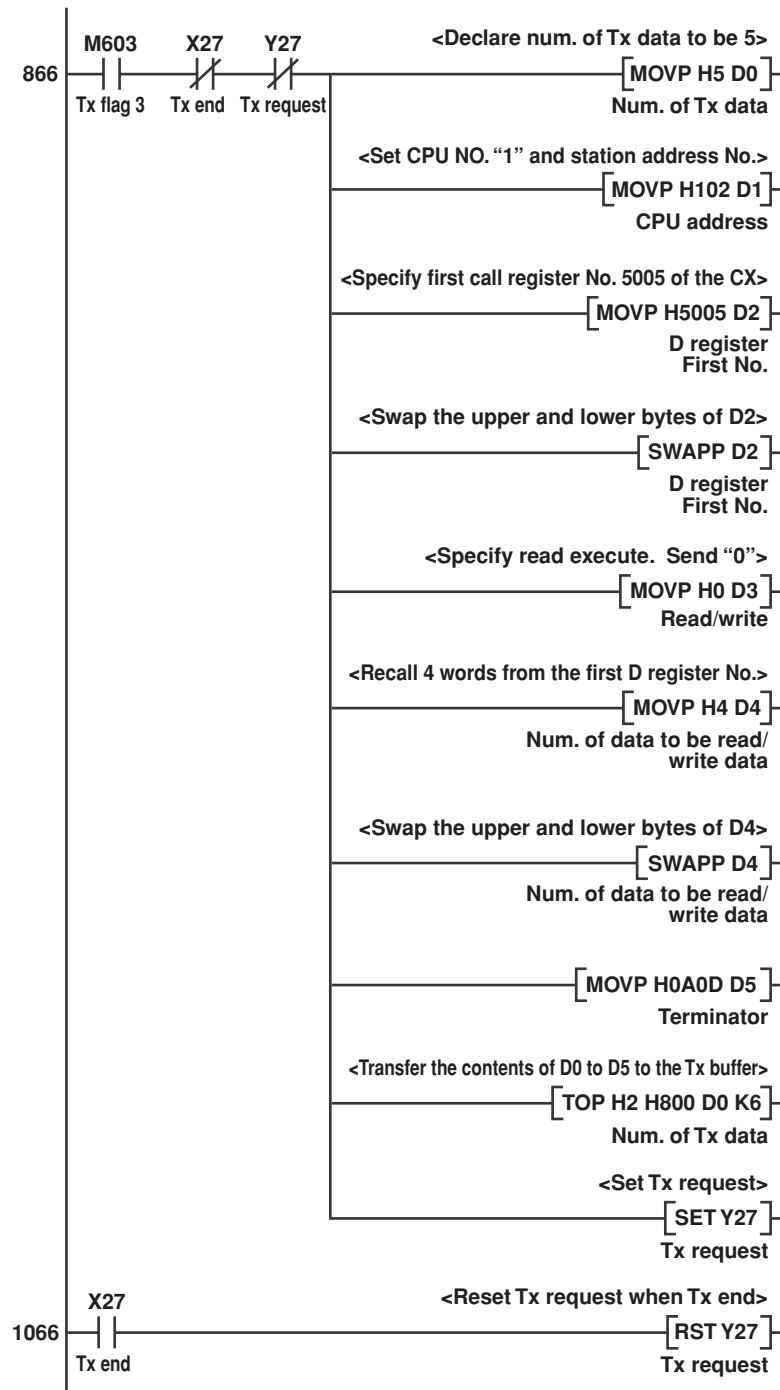

- Reception processing: Receive the data of CH5 to CH8.

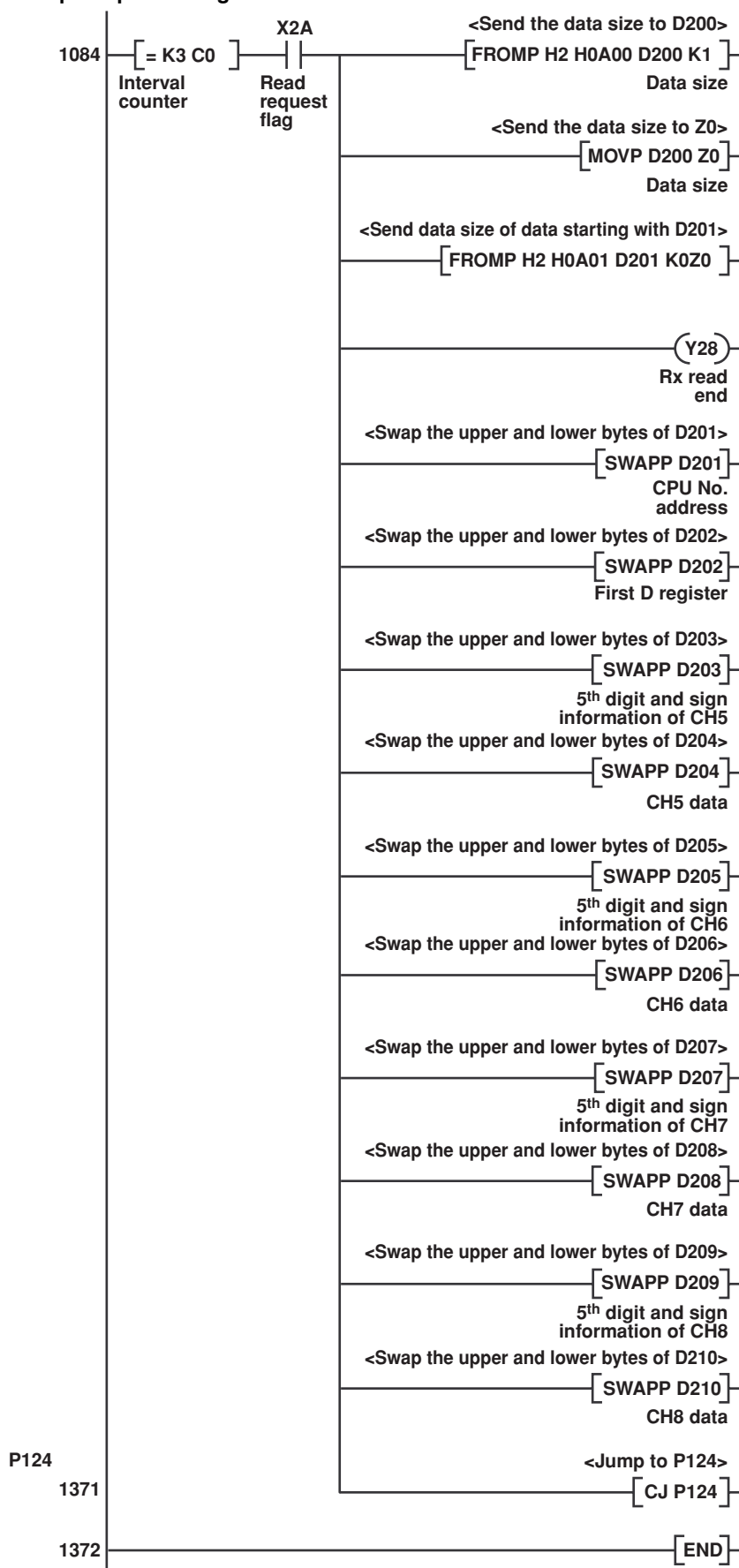

6.1 Command Syntax

Command Syntax

The syntax of the setting/basic setting/control/output commands (see sections 6.4 to 6.12) used by the CX is given below. ASCII codes (see appendix 1) are used for the character codes. For the syntax of the maintenance/test commands (see section 6.13) and instrument information output commands (see section 6.14), see the corresponding sections or the examples for each command.

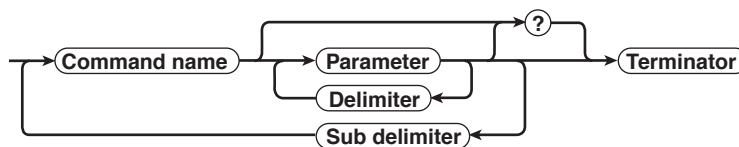

Command example

SR 02,SKIP;SR 03,VOLT,2V,-1500,1800

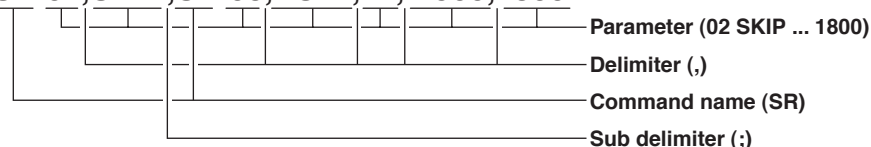

Command Name

Defined using two alphabet characters.

Parameters

- Command parameters.
- Set using alphabet characters or numerical values.
- Parameters are separated by delimiters (commas).
- All numerical values are specified using integers.
- When the parameter is a numerical value, the valid range of the value varies depending on the command.
- Spaces before and after of the parameter are ignored (except for parameters that are specified using an ASCII character string (unit), in which case spaces are valid.)
- You can omit the parameters that do not need to be changed from their current settings. However, delimiters cannot be omitted.

Example SR01,,2V<terminator>

If multiple parameters are omitted and delimiters occur at the end of the command, those delimiters can be omitted.

Example SR01,VOLT,,, <terminator> → SR01,VOLT<terminator>

- The number of digits of the following parameters is fixed. If the number is exceeded when entering the command, a syntax error results.
 - Date YY/MM/DD (8 characters)
 YY: Enter the lower two digits of the year.
 MM: Month
 DD: Day
 - Time HH:MM:SS (8 characters)
 HH: Hour
 MM: Minute
 SS: Second

6.1 Command Syntax

- Channel number
 - 01 to 20: Measurement channels (01 to 06 on the CX1000)
 - 31 to 60: Computation channels (31 to 42 on the CX1000)
 - 101 to 118: Internal control channels (101 to 106 on the CX1000)
 - Example Loop1 PV = 101
 - Loop1 SP = 102
 - Loop1 OUT = 103
 - 201 to 248: External control channels (201 to 212 on the CX1000)
 - Example Loop EXT1 PV = 201
 - Loop EXT1 SP=202
 - Loop EXT1 OUT = 203
- Relay number: 3 characters

Query

- A question mark is used to specify a query.
- By placing a query after a command or parameter, the setup information of the corresponding command can be queried. Some commands cannot execute queries. For the query syntax of each command, see sections 6.4 to 6.7.

Example 1 SR[p1]? SR? or SR p1? can be executed.

Example 2 SA[p1 [,p2]]? SA?, SA p1?, or SA p1 ,p2? can be executed.

Delimiter

- A comma is used as a delimiter.
- Parameters are separated by delimiters.

Sub Delimiter

- A semicolon is used as a sub delimiter.
- By separating each command with a sub delimiter, up to 10 commands can be specified one after another. However, the following commands and queries cannot be specified one after another. Use them independently.
 - Output commands other than BO, CS, and IF commands.
 - YO command
 - Queries

* If there are consecutive sub delimiters, they are considered to be single. In addition, sub delimiters at the front and at the end of the command are ignored.

Example ;SR01 ,VOLT; ;SR02 ,VOLT;<terminator> is taken to be
SR01 ,VOLT;SR02 ,VOLT<terminator>.

Terminator

Use either of the following two characters for the terminator.

- CR+LF (0DH 0AH in ASCII code)
- LF (0AH in ASCII code)

Note

- Do not specify a channel or relay number that is not available on the CX. An error will occur.
 - The total data length from the first character to the terminator must be less than or equal to 2047 bytes.
 - Commands are not case sensitive (with the exception of user-specified character strings).
 - All the commands that are listed using sub delimiters are executed even if any of the commands in the middle is erroneous.
 - Spaces that are inserted before and after a parameter are ignored. However, if spaces are inserted before a command, after a sub delimiter, or after a query, an error occurs.
-

Response

The CX returns a response (affirmative/negative response) to a command that is delimited by a single terminator.* The controller should follow the one command to one response format. When the command-response rule is not followed, the operation is not guaranteed. For the response syntax, see section 7.1.

* Commands dedicated to RS-422/485 (see section 6.12) and instrument information output commands (section 6.15) are exceptions.

6.2 A List of Commands

Setting Commands (Control)

Command Type	Command Name	Function	Execution mode	ADMINISTRATOR	USER	Page
Control Input Range						
	CR	Sets the control range	Operation mode	Yes	No	6-15
	MP	Control range settings (used during control computations)	Operation mode	Yes	No	6-16
	MB	Bias	Operation mode	Yes	No	6-16
	MF	Filter	Operation mode	Yes	No	6-17
	RS	Set the ratio	Operation mode	Yes	No	6-17
Control Alarm						
	AT	Sets the control alarm	Operation mode	Yes	No	6-17
	AV	Sets the control alarm value	Operation mode	Yes	No	6-17
Operation-related Parameters						
	HS	Sets the suppressing function	Operation mode	Yes	No	6-17
	HT	Sets the ramp-rate-time unit	Operation mode	Yes	No	6-17
	HH	Sets the SP ramp-up-rate	Operation mode	Yes	No	6-18
	HL	Sets the SP ramp-down-rate	Operation mode	Yes	No	6-18
	HM	Sets the loop tag and tag comment	Operation mode	Yes	No	6-18
	GC	Zone PID setting 1 (reference points)	Operation mode	Yes	No	6-18
	GD	Zone PID setting 2 (switching hysteresis)	Operation mode	Yes	No	6-18
	HW	Zone PID setting 3 (reference deviation)	Operation mode	Yes	No	6-18
PID Parameters						
	GO	Sets the target setpoint	Operation mode	Yes	No	6-18
	HP	Sets the proportional band	Operation mode	Yes	No	6-18
	HI	Sets the integral time	Operation mode	Yes	No	6-18
	HD	Sets the derivative time	Operation mode	Yes	No	6-19
	HO	Sets control-related parameters	Operation mode	Yes	No	6-19
Control Group Settings						
	FG	Sets the control group name	Operation mode	Yes	No	6-19
	GG	Sets the control group	Operation mode	Yes	No	6-19
Ten-segment Linearizer Input/Output						
	HA	Sets the ten-segment linearizer mode	Operation mode	Yes	No	6-20
	HE	Sets the ten-segment linearizer segment	Operation mode	Yes	No	6-20
Pattern Initial Setting						
	PB	Sets initial patterns	Operation mode	Yes	No	6-20
	PI	Operating loop settings	Operation mode	Yes	No	6-20
Wait Action Setting						
	PZ	Sets the wait zone	Operation mode	Yes	No	6-21
	PW	Sets the wait time	Operation mode	Yes	No	6-21
Program Initial Setting						
	PO	Sets the start setpoint	Operation mode	Yes	No	6-21
	PQ	Sets the start code	Operation mode	Yes	No	6-21
Program Operation Parameters						
	PD	Sets the ramp/soak select	Operation mode	Yes	No	6-21
	PM	Sets the final target setpoint	Operation mode	Yes	No	6-21
	PT	Sets the segment time	Operation mode	Yes	No	6-21
	PU	Sets the ramp-rate time unit/ramp	Operation mode	Yes	No	6-21
	PG	Segment PID group number	Operation mode	Yes	No	6-21
	PJ	Sets the segment shifting action and wait	Operation mode	Yes	No	6-21

Yes: Command usable

No: Command not usable

6.2 A List of Commands

Command Type	Command Name	Function	Execution mode	ADMINISTRATOR	USER	Page
Event Setting						
	ET	Sets the time event	Operation mode	Yes	No	6-21
	EP	Sets the PV event	Operation mode	Yes	No	6-22
Event Output Setting						
	EO	Sets the event output	Operation mode	Yes	No	6-22
	PA	Program pattern end signal	Operation mode	Yes	No	6-22
Repeat Action Setting						
	PR	Sets the repeating action	Operation mode	Yes	No	6-22
Program End						
	PE	End programming	Operation mode	Yes	No	6-22
Auto message for program Run/Reset						
	PK	Set the auto message for program run/reset	Operation mode	Yes	No	6-22
Program display position						
	PL	Set the program display position	Operation mode	Yes	No	6-22
Auto change to program run display						
	MQ	Auto change to program run display	Operation mode	Yes	No	6-22
Event display group						
	PV	Set the event display group	Operation mode	Yes	No	6-22
Detail Settings (Control Function Settings)						
	HF	Sets the setpoint	Operation mode	Yes	No	6-23
	GL	Sets the output velocity limiter	Operation mode	Yes	No	6-23
	GA	Sets the anti-reset windup function	Operation mode	Yes	No	6-23
Detail Settings (Hysteresis (Alarm, PV Event))						
	AP	Sets the alarm hysteresis	Operation mode	Yes	No	6-23
	PH	Sets the PV event hysteresis	Operation mode	Yes	No	6-23
Detailed settings (DIO operation monitoring and function settings)						
	DX	Set the DIO operation monitoring function	Operation mode	Yes	No	6-23
	DY	Set the DIO operation monitoring function tag and tag comment	Operation mode	Yes	No	6-24
	DZ	Set the DIO operation monitoring function label and display color	Operation mode	Yes	No	6-24
Detailed settings (DI/DO label settings)						
	DW	Set the DI/DO label	Operation mode	Yes	No	6-24
Control computation						
	MT	Se the equation	Operation mode	Yes	No	6-25
	MU	Se the computation error	Operation mode	Yes	No	6-25
	MV	Se the logic computation	Operation mode	Yes	No	6-25
	MX	Se the computation constant	Operation mode	Yes	No	6-25
	DU	Se the remote bias	Operation mode	Yes	No	6-25
External Loop Setting (PID Parameter)						
	DT	Sets the external loop PID parameter	Basic setting mode	Yes	No	6-26
External Loop Setting (Control Parameter)						
	DV	Sets the external loop control parameter	Basic setting mode	Yes	No	6-26

Yes: Command usable
No: Command not usable

6.2 A List of Commands

Setting Commands (Measurement)

Command Type	Command Name	Function	Execution mode	ADMINISTRATOR	USER	Page
Settings						
	SR	Sets the input range	Operation mode	Yes	No	6-27
	SO	Sets the computing equation	Operation mode	Yes	No	6-28
	SA	Setting the alarm	Operation mode	Yes	No	6-29
	SD	Sets the date and time	Operation mode	Yes	No	6-30
	SW	Sets the display update rate/auto-save interval	Operation mode	Yes	No	6-30
	SZ	Sets the zone	Operation mode	Yes	No	6-30
	SP	Sets the partial expanded display	Operation mode	Yes	No	6-30
	ST	Sets the tag	Operation mode	Yes	No	6-31
	SX	Sets the group	Operation mode	Yes	No	6-31
	SL	Sets the trip line	Operation mode	Yes	No	6-31
	SG	Sets the message	Operation mode	Yes	No	6-31
	SH	Sets the file header	Operation mode	Yes	No	6-31
	SE	Sets the display direction, background color, trend line width, trip line width, number of grids, and scroll time	Operation mode	Yes	No	6-31
	SB	Sets the number of scale divisions, base position of the bar graph, and the display position of the trend scale	Operation mode	Yes	No	6-32
	SV	Sets the moving average of the measured channel	Operation mode	Yes	No	6-32
	SC	Sets the channel display color	Operation mode	Yes	No	6-32
	SQ	Sets the LCD brightness and the screen backlight saver	Operation mode	Yes	No	6-32
	SY	Sets the 4 screen display	Operation mode	Yes	No	6-33
	SU	Sets the USER key	Operation mode	Yes	No	6-33
	SK	Sets the computation constant	Operation mode	Yes	No	6-33
	SI	Sets the rolling average of the computation channel	Operation mode	Yes	No	6-34
	SJ	Sets the TLOG timer	Operation mode	Yes	No	6-34
	SS	Set the date and time at which to switch the daylight savings time	Operation mode	Yes	No	6-34
	FR	Sets the interval for acquiring data to the FIFO buffer	Operation mode	Yes	No	6-35
	BA	Sets the application name, the supervisor name, and the manager name	Operation mode	Yes	No	6-35
	BB	Sets the batch number, the lot number, automatic increment of the lot number, and the displayed information	Operation mode	Yes	No	6-35
	BC	Sets the comment number and the character string	Operation mode	Yes	No	6-35
	BD	Sets the alarm delay	Operation mode	Yes	No	6-35

Yes: Command usable
No: Command not usable

Note

- There are two execution modes on the CX. If you attempt to execute a command in a mode that is different from the specification, a syntax error occurs. Use the DS command to switch to the appropriate execution mode, then execute the command. Query commands can be executed in either mode.
 - Basic setting mode
Measurement, computation, and control are stopped, and settings are changed in this mode.
 - Operation mode
As a general rule, commands other than those for the basic setting mode described above are used in this mode.
- The ADMINISTRATOR and USER specifications in the table indicate the user level that is specified using the login function for Ethernet communications. For details, see section 2.7.

Command Type	Command Name	Function	Execution mode	ADMINISTRATOR	USER	Page
Operation						
	UD	Switches the screen	Operation mode	Yes	No	6-36
	PS	Starts/Stops measurements	Operation mode	Yes	No	6-37
	AK	Confirms the alarm status (alarm acknowledge)	Operation mode	Yes	No	6-37
	EV	Saves the manual sample, manual trigger, snapshot, display data, saves the event data	Operation mode	Yes	No	6-37
	MS	Writes the message (display and save)	Operation mode	Yes	No	6-38
	TL	Starts/stops/resets computation (MATH) Clears the computation dropout status display	Operation mode	Yes	No	6-38
	DS	Switches execution modes (operation/basic setting)	All modes	Yes	No	6-38
	LO	Loads the setup data for setting commands	Operation mode	Yes	No	6-38
	LI	Saves the setup data	Operation mode	Yes	No	6-39
	CM	Sets the communication input data	Operation mode	Yes	No	6-39
	EM	Starts/Stops e-mail messages	Operation mode	Yes	No	6-39
	DL	Switches the operation mode for DIO operation monitoring	Operation mode	Yes	No	6-39
	DM	Sets the manual output value for DIO operation monitoring function	Operation mode	Yes	No	6-39
	DP	Starts/Stops e-mail messages	Operation mode	Yes	No	6-39

Yes: Command usable

No: Command not usable

Basic Setting Commands (Measurement)

- In order to activate the settings that are changed using the basic setting commands, the settings must be saved using the XE command. Make sure to save the settings with the XE command before changing from the basic setting mode to the operation mode. Otherwise, new settings will not be activated.
- The settings that are returned in response to a query in the basic setting mode will contain the new settings even if they are not saved with the XE command. However, the new settings will not be activated until they are saved. In order to activate the new settings, the XE command must be issued as described earlier. If the settings are not saved or cleared using the XE command and the execution mode is changed from the basic setting mode to the operation mode, the settings that are returned in the response to a query will contain the settings that existed before they were changed.

Note

- The settings that are changed using the YA/YK/YN/YQ/YS/YG/YL/YM command are activated after saving the new settings using the XE command and rebooting the CX.
- When the YO command executed, the communication is disconnected.

Command Name	Function	Execution mode	ADMINISTRATOR	USER	Page
XA	Sets alarm related settings	Basic setting mode	Yes	No	6-40
XI	Sets the A/D integral time	Basic setting mode	Yes	No	6-40
XB	Sets the burn out	Basic setting mode	Yes	No	6-40
XJ	Sets the RJC	Basic setting mode	Yes	No	6-40
XV	Sets the scan interval	Basic setting mode	Yes	No	6-41
XT	Selects the temperature unit	Basic setting mode	Yes	No	6-41
XS	Sets the channels to display the trend and acquire the data	Basic setting mode	Yes	No	6-41
XM	Sets the conditions used to acquire display/event data to the internal memory or save the data to the external storage medium	Basic setting mode	Yes	No	6-41
XU	Sets the channel identification display, memory alarm time, language, whether or not to use the partial expanded display function and the batch function	Basic setting mode	Yes	No	6-41
XR	Sets the remote action	Basic setting mode	Yes	No	6-42
XQ	Sets the timer	Basic setting mode	Yes	No	6-42
RO	Sets the report type and generation time	Basic setting mode	Yes	No	6-42
RM	Sets the report channel	Basic setting mode	Yes	No	6-43
XO	Selects the communication interface used to output data residing in the internal memory (display, event, TLOG, manual sampled, and report data) and files on the external storage medium using output commands (ME/MI/MO commands)	Basic setting mode	Yes	No	6-44
XH	Sets whether or not to use the key login, auto logout, and user ID functions	Basic setting mode	Yes	No	6-44
XE	Sets whether or not to store the basic settings	Basic setting mode	Yes	No	6-44
XG	Sets the time zone	Basic setting mode	Yes	No	6-44
XP	Sets the memory timeup date and time	Basic setting mode	Yes	No	6-44
YA	Sets the IP address, subnet mask, and default gateway	Basic setting mode	Yes	No	6-45
YK	Sets keep alive	Basic setting mode	Yes	No	6-45
YN	Sets the DNS	Basic setting mode	Yes	No	6-45
YQ	Sets the communication timeout	Basic setting mode	Yes	No	6-45
YS	Sets the serial interface	Basic setting mode	Yes	No	6-45

Command Name	Function	Execution mode	ADMINISTRATOR	USER	Page
YO	Loads setup data	Basic setting mode	Yes	No	6-46
YC	Clears the measured/computed data, initializes setup data	Basic setting mode	Yes	No	6-46
YT	Sets the FTP transfer timing	Basic setting mode	Yes	No	6-46
YG	Sets whether to use the Web server function	Basic setting mode	Yes	No	6-46
YL	Sets the operation of the Modbus master function	Basic setting mode	Yes	No	6-46
YM	Sets the command of the Modbus master function	Basic setting mode	Yes	No	6-46
YU	Sets the contents to be sent via e-mail	Basic setting mode	Yes	No	6-47
YV	Sets the e-mail recipient address	Basic setting mode	Yes	No	6-48
YW	Sets the e-mail sender address	Basic setting mode	Yes	No	6-48
YX	Sets the e-mail SMTP server name	Basic setting mode	Yes	No	6-48
ML	Sets the communication buffer recovery processing	Basic setting mode	Yes	No	6-48
MM	Sets the modbus mouse/temperature meter communication automatic recovery	Basic setting mode	Yes	No	6-48

Yes: Command usable
No: Command not usable

Basic Setting Commands (Control)

Command Type	Command Name	Function	Execution mode	ADMINISTRATOR	USER	Page
Control Action, Input Setting						
	GB	Sets the PID group number	Basic setting mode	Yes	No	6-49
	GI	Sets the control period	Basic setting mode	Yes	No	6-49
	HX	Sets control action parameters	Basic setting mode	Yes	No	6-49
	PY	Sets 6/4loop select (CX2000 only)	Basic setting mode	Yes	No	6-49
	HQ	Turns Off/On auto tuning	Basic setting mode	Yes	No	6-49
	PC	Sets the control mode	Basic setting mode	Yes	No	6-49
	PP	Turns Off/On the program control	Basic setting mode	Yes	No	6-49
	GM	Sets the PID control mode	Basic setting mode	Yes	No	6-49
	HB	Sets the burn out	Basic setting mode	Yes	No	6-49
	MK	Sets the burn out (when PV/SP computation is ON)	Basic setting mode	Yes	No	6-50
	HR	Sets the RJC	Basic setting mode	Yes	No	6-50
	MJ	Sets the RJC (when PV/SP computation is ON)	Basic setting mode	Yes	No	6-50
Contact Input Registration/AUX						
	GT	Registers contact inputs	Basic setting mode	Yes	No	6-50
	GS	Sets remote input	Basic setting mode	Yes	No	6-51
	HG	Sets the alarm mode	Basic setting mode	Yes	No	6-51
	HY	Sets the SP number selection source	Basic setting mode	Yes	No	6-51
	MY	Turns Off/On PV/SP computation	Basic setting mode	Yes	No	6-51
	MZ	Sets the CLOG error	Basic setting mode	Yes	No	6-51
Output Processing						
	GF	Sets the output processing	Basic setting mode	Yes	No	6-51
Relay						
	GR	Sets relay parameters	Basic setting mode	Yes	No	6-51
	GE	Sets relay action	Basic setting mode	Yes	No	6-51
Tuning Setting						
	GU	Turns Off/On the tuning item	Basic setting mode	Yes	No	6-52

6.2 A List of Commands

Command Type	Command Name	Function	Execution mode	ADMINISTRATOR	USER	Page
External Loop Setting (Basic Setting)						
	GJ	Specifies external loop	Basic setting mode	Yes	No	6-52
	GK	External loop parameter auto reading execute command	Basic setting mode	Yes	No	6-52
	GV	External loop parameter 4, parameter type/ decimal point position and unit	Basic setting mode	Yes	No	6-52
	GH	External loop parameter 1, control span lower/upper limit	Basic setting mode	Yes	No	6-53
	GQ	External loop parameter 3, control mode/ control output type	Basic setting mode	Yes	No	6-53
	GN	External loop parameter 2, alarm number/ alarm type	Basic setting mode	Yes	No	6-53
External Loop Setting (Parameter Address Setting)						
	GW	Sets the external loop parameter address	Basic setting mode	Yes	No	6-53

Yes: Command usable
No: Command not usable

Control Commands

Command Type	Command Name	Function	Execution mode	ADMINISTRATOR	USER	Page
Control Commands						
	CA	Switches between auto, manual, and cascade control	Operation mode	Yes	No	6-54
	OC	Switches run/stop	Operation mode	Yes	No	6-54
	RL	Switches remote/local	Operation mode	Yes	No	6-54
	OS	Stops/Starts control operation (common to all loops)	Operation mode	Yes	No	6-54
	SN	Switches target setpoint number	Operation mode	Yes	No	6-54
	PX	Resets/Runs program	Operation mode	Yes	No	6-54
	HU	Holds program operation	Operation mode	Yes	No	6-54
	AD	Advances program operation	Operation mode	Yes	No	6-54
	PN	Switches the pattern number	Operation mode	Yes	No	6-54
	HJ	Changes the manual output setting	Operation mode	Yes	No	6-54
	HV	Requests auto tuning	Operation mode	Yes	No	6-54

Yes: Command usable
No: Command not usable

Output Commands (Measurement)

Command Type	Command Name	Function	Execution mode	ADMINISTRATOR	USER	Page
Control						
	BO	Sets the byte output order.	All modes	Yes	Yes	6-55
	CS	Sets the check sum (usable only during serial communications)	All modes	Yes	Yes	6-55
	IF	Sets the status filter	All modes	Yes	Yes	6-55
	CC	Disconnects Ethernet connection (usable only during Ethernet communications)	All modes	Yes	Yes	6-55

Command Type	Command Name	Function	Execution mode	ADMINISTRATOR	USER	Page
Setup, Measurement, and computation Data Output						
	FC	Outputs the screen image data	All modes	Yes	Yes	6-55
	FE	Outputs the setup data	All modes	Yes	Yes	6-55
	FD	Outputs the newest measured/computed/control data	Operation mode	Yes	Yes	6-56
	FF	Outputs FIFO data	Operation mode	Yes	Yes	6-56
	FL	Outputs log, alarm summary, and message summary	All modes	Yes	Yes	6-56
	FS	Outputs alarm types and setting value for measurement/computation/control channel	All modes	Yes	Yes	6-57
	FT	Outputs max/min/decimal point of span for measurement/computation/control channel	All modes	Yes	Yes	6-57
	IS	Outputs status information	All modes	Yes	Yes	6-57
	FU	Outputs the user level	All modes	Yes	Yes	6-57
	ME	Outputs the data stored on the external storage medium (usable through either Ethernet or serial communications)	Operation mode	Yes	No	6-57
	MI	Outputs display data and event data in the internal memory (usable through either Ethernet or serial communications)	Operation mode	Yes	No	6-57
	MO	Outputs TLOG data, manual sample data, and report data in the internal memory (usable through either Ethernet or serial communications)	Operation mode	Yes	No	6-58
RS-422/485 Dedicated Commands						
	ESC O	Opens the device	All modes	Yes	Yes	6-59
	ESC C	Closes the device	All modes	Yes	Yes	6-59

Yes: Command usable
No: Command not usable

Output Commands (Control)

Command Type	Command Name	Function	Execution mode	ADMINISTRATOR	USER	Page
output commands						
	FP	Outputs the SP number and PID number.	All modes	Yes	Yes	6-59
	FM	Outputs the control mode.	All modes	Yes	Yes	6-59
	FH	Outputs the program operation mode.	All modes	Yes	Yes	6-59
	FJ	Outputs program pattern information that is currently in execution.	All modes	Yes	Yes	6-60
	FK	Outputs PV event/time event information.	All modes	Yes	Yes	6-60
	FN	Outputs the DI/DO data and internal switches status.	All modes	Yes	Yes	6-60
	FO	Outputs the status (active/inactive) of DIO operation monitoring function setting and operation mode (automatic/manual).	All modes	Yes	Yes	6-60
	FW	Outputs the information on pattern numbers, operation status, and assigned loops.	All modes	Yes	Yes	6-60
	DQ	Outputs the SP number and PID number of external loops.	All modes	Yes	Yes	6-60
	DR	Outputs the control mode of external loops.	All modes	Yes	Yes	6-60
	FV	Outputs the status of the program control end signal	All modes	Yes	Yes	6-61

Yes: Command usable
No: Command not usable

6.2 A List of Commands

Maintenance/Test Commands (Available when using the maintenance/test server function via Ethernet communications)

Command Name	Function	ADMINISTRATOR	USER	Page
close	Disconnects the connection between other devices	Yes	No	6-61
con	Outputs connection information	Yes	Yes	6-61
eth	Outputs Ethernet statistical information	Yes	Yes	6-62
help	Outputs help	Yes	Yes	6-62
net	Outputs network statistical information	Yes	Yes	6-62
quit	Disconnects the connection of the device being operated	Yes	Yes	6-62

Yes: Command usable

No: Command not usable

Instrument Information Output Commands (Available when using the instrument information server function via Ethernet communications)

Parameter	Function	Page
all	Outputs all information that are output using the parameters below	6-63
serial	Outputs the serial number	6-63
model	Outputs the manufacturer, model, and firmware version	6-63
host	Outputs the host name	6-63
ip	Outputs the IP address	6-63

6.3 Input Range Parameter

The following tables show which measurement ranges of the instrument correspond to the input types of the CR command (control input range setting command) and SR command (input range setting command), VOLT, TC, RTD, DI, and SQRT. The table also shows the ranges for the upper and lower limits of the span.

DC Voltage (VOLT) and Square Root Computation (SQRT)

Measurement Range	Parameter for the CR/SR Command	Upper and Lower Limits of the Span	Upper and Lower Limits of the Span for the CR/SR Command
20 mV	20mV	-20.00 to 20.00 mV	-2000 to 2000
60 mV	60mV	-60.00 to 60.00 mV	-6000 to 6000
200 mV	200mV	-200.0 to 200.0 mV	-2000 to 2000
2 V	2V	-2.000 to 2.000 V	-2000 to 2000
6 V	6V	-6.000 to 6.000 V	-6000 to 6000
20 V	20V	-20.00 to 20.00 V	-2000 to 2000
50 V	50V	-50.00 to 50.00 V	-5000 to 5000

Thermocouple (TC)

Measurement Range	Parameter for the CR/SR Command	Upper and Lower Limits of the Span	Upper and Lower Limits of the Span for the CR/SR Command
R	R	0.0 to 1760.0 °C	0 to 17600
S	S	0.0 to 1760.0 °C	0 to 17600
B	B	0.0 to 1820.0 °C	0 to 18200
K	K	-200.0 to 1370.0 °C	-2000 to 13700
E	E	-200.0 to 800.0 °C	-2000 to 8000
J	J	-200.0 to 1100.0 °C	-2000 to 11000
T	T	-200.0 to 400.0 °C	-2000 to 4000
N	N	0.0 to 1300.0 °C	0 to 13000
W	W	0.0 to 2315.0 °C	0 to 23150
L	L	-200.0 to 900.0 °C	-2000 to 9000
U	U	-200.0 to 400.0 °C	-2000 to 4000
PLATI	PLATI	0.0 to 1400.0 °C	0 to 14000
PR	PR	0.0 to 1900.0 °C	0 to 19000
WRe	WRe	0.0 to 2400.0 °C	0 to 24000

Resistance Temperature Detector (RTD)

Measurement Range	Parameter for the CR/SR Command	Upper and Lower Limits of the Span	Upper and Lower Limits of the Span for the CR/SR Command
Pt100 PT	-200.0 to 600.0 °C	-2000 to 6000	
JPt100	JPT	-200.0 to 550.0 °C	-2000 to 5500
Cu10 (GE)*	CU1	-200.0 to 300.0 °C	-2000 to 3000
Cu10 (L&N)*	CU2	-200.0 to 300.0 °C	-2000 to 3000
Cu10 (WEED)*	CU3	-200.0 to 300.0 °C	-2000 to 3000
Cu10 (BAILEY)*	CU4	-200.0 to 300.0 °C	-2000 to 3000
Cu10 $\alpha=0.00392$ at 20 °C*	CU5	-200.0 to 300.0 °C	-2000 to 3000
Cu10 $\alpha=0.00393$ at 20 °C*	CU6	-200.0 to 300.0 °C	-2000 to 3000
Cu25 $\alpha=0.00425$ at 0 °C*	CU25	-200.0 to 300.0 °C	-2000 to 3000

* Input range that can be specified on models with the Cu10, Cu25 resistance temperature detector option /N1.

6.3 Input Range Parameter

ON/OFF input (DI)

Measurement Range	Parameter for the CR/SR Command	Upper and Lower Limits of the Span	Upper and Lower Limits of the Span for the CR/SR Command
Voltage	LEVEL	0 or 1 ^{*1}	0 or 1
Contact	CONT	0 or 1 ^{*2}	0 or 1

*1: "0" when less than 2.4 V, "1" when greater than or equal to 2.4 V.

*2: "0" when contact is OFF, "1" when contact is ON.

Note

For the measurement accuracy of each measurement range, see the *user's manual IM 04L31A01-01E* or *IM 04L31A01-03E*.

6.4 Setting Commands (Control)

Control Input Range

CR Set the control range

When p1 = 1 to 6 (When internal loop is specified)

When p2 = PV1, PV2, or RemoteSP

When p3 = TC or RTD

Syntax CR p1 , p2 , p3 , p4 , p5 , p6 , p7 , p8 <terminator>
 p1: Loop number (1 to 6) (1 or 2 on the CX1000)
 p2: Input type (PV1, PV2, RemoteSP)
 p3: Mode (TC, RTD)
 p4: Range
 p3 = TC
 (R,S,B,K,E,J,T,N,W,L,U,PLATI,PR,WRe)
 p3 = RTD (JPT,PT)
 p5: Span lower limit EU (0.0 to 100.0%)
 p6: Span upper limit EU (0.0 to 100.0%)
 p7: Enable/disable square root computation (Off, On)
 p8: Low-cut value (0.0% to 5.0%)

Query CR[p1 , p2]?

Example Set loop 1 PV1 as follows: Input type: TC and R, span lower limit: 0°C, span upper limit:1760.0°C, low-cut value: 1.0%.
 CR1 , PV1 , TC , R , 0 , 17600 , ON , 10

When p1 = 1 to 6 (When internal loop is specified)

When p2 = PV1, PV2, or RemoteSP

When p3 = Standard range (1-5 V)

Syntax CR p1 , p2 , p3 , p4 , p5 , p6 , p7 , p8 , p9 <terminator>
 p1: Loop number (1 to 6) (1 or 2 on the CX1000)
 p2: Input type (PV1, PV2, RemoteSP)
 p3: Mode (1-5V)
 p4: Scale lower limit (–30000 to 30000)
 p5: Scale upper limit (–30000 to 30000)
 P5-P4 ≤ 30000
 p6: Decimal point position (0 to 4)
 p7: Unit
 p8: Enable/disable square root computation (Off, On)
 p9: Low-cut value (0.0% to 5.0%)

Query CR[p1 , p2]?

Example Set loop 1 Remote SP as follows: Input type: Standard range, scaling lower limit: 1.00 A, scaling upper limit: 5.00 A, square root computation: Off
 CR1 , REMOTESP , 1-5V , 100 , 500 , 2 , A , OFF

When p1 = 1 to 6 (When internal loop is specified)

When p2 = PV1, PV2, or RemoteSP

When p3 = Scale

Syntax CR p1 , p2 , p3 , p4 , p5 , p6 , p7 , p8 , p9 , p10 , p11 , p12 , p13 <terminator>

p1: Loop number (1 to 6) (1 or 2 on the CX1000)
 p2: Input type (PV1, PV2, RemoteSP)
 p3: Mode (Scale)
 p4: Type (DCV, TC, RTD)
 p5: Range
 p4=DCV(20mV,60mV,200mV,2V,6V,20V,50V)
 p4=TC(R,S,B,K,E,J,T,N,W,L,U,PLATI,PR,WRe)
 p4=RTD(JPT,PT)
 p6: Span lower limit EU (0.0 to 100.0%)
 p7: Span upper limit EU (0.0 to 100.0%)
 p8: Scale lower limit (–30000 to 30000)
 p9: Scale upper limit (–30000 to 30000)
 P9-P8 ≤ 30000
 p10: Decimal point position (0 to 4)
 p11: Unit (up to 6 characters)
 p12: Enable/disable square root computation (Off, On)
 p13: Low-cut value (0.0% to 5.0%)

Query CR[p1 , p2]?

Example Convert the voltage measured with loop 1 to a value in units of mV. Set the items as follows: Range: 2 V, span lower limit: –2 V, span upper limit: 2 V, scaling lower limit: –2000 mV, scaling upper limit: 2000 mV, low-cut value: 0%
 CR1 , PV1 , SCALE , DCV , 2V , -2000 , 2000 , -2000 , 2000 , 0 , mV , ON , 0

When p1 = 1 to 6 (When internal loop is specified)
 When p2=PVrange

Syntax CR p1 , p2 , p3 , p4 , p5 , p6 , p7 , p8 <terminator>
 p1: Loop number (1 to 6) (1 or 2 on the CX1000)
 p2: Input type (PVrange)
 p3: PV range lower limit (–30000 to 30000)
 p4: PV range upper limit (–30000 to 30000)
 P4-P3 ≤ 30000
 p5: Decimal point position (0 to 4)
 p6: Unit (up to 6 characters)
 p7: Input switch PV lower limit (–30000 to 30000 loops)
 within p3 and p4
 p8: Input switch PV upper limit (–30000 to 30000 loops)
 within p3 and p4
 P8>P7

Note) p7 is used only setting the temperature range The meaning of the parameter changes.

In other words, p8 becomes p7.

Query CR[p1 , p2]?

Example With the switching method of loop 2 set to “Range,” set the items as follows: PV range lower limit: –500.0°C, upper limit: 2500°C, PV switching lower limit: 0.0, upper limit: 400.0
 CR2 , PVRANGE , -5000 , 25000 , 1 , ^C , 0 , 4000

6.4 Setting Commands (Control)

With the switching method of loop 2 set to "PVHigh," set the items as follows: PV range lower limit: -10000, upper limit: 20000, PV switching lower limit: 10000. (No unit)
 CR2,PVRANGE,-10000,20000,0, ,10000
 With the switching method of loop 2 set to "Signal," set the items as follows: PV range lower limit: 0.00 V, upper limit: 40.00 V.
 CR2,PVRANGE,0,4000,2

MP Control setting range

When p2=TC, RTD

Syntax MP p1,p2,p3,p4,p5,p6,p7<terminator>
 p1: Control input channel numbers (CI01–CI10, or CI01–CI05 for the CX1000)
 p2: Mode (TC, RTD)
 p3: Measuring range designation
 p3 = TC
 (R, S, B, K, E, J, T, N, W, L, U, PLATI, PR, WRe)
 p3 = RTD (JPT, PT)
 p4: Span lower limit EU (0.0–100.0%)
 p5: Span upper limit EU (0.0–100.0%)
 p6: Enable/disable square root computation (Off, On)
 p7: Low-cut value (0.0% to 5.0%)
Query MP[p1]?
Example Set the input type of CI01 to thermocouple R, lower limit of span to 0°C, lower limit of span to 1760.0°C, and the low signal cutoff value to 1.0%.
 MPC101,TC,R,0,17600,ON,10

When p2=Standard range (1-5 V)

Syntax MP p1,p2,p3,p4,p5,p6,p7,p8<terminator>
 p1: Control input channel numbers (CI01–CI10, or CI01–CI05 for the CX1000)
 p2: Mode (1–5 V)
 p3: Scale lower limit (-30000–30000)
 p4: Scale upper limit (-30000–30000)
 P5-P4≤30000
 p5: Decimal point position (0–4)
 p6: Units
 p7: Enable/disable square root computation (Off, On)
 p8: Low-cut value (0.0% to 5.0%)
Query MP[p1]?
Example Set the input type of CI02 to unified range, the scaling lower limit value to 1.00 A, the scaling upper limit value to 5.00 A, and specify no square root extraction.
 MPC102,1-5V,100,500,2,A,OFF

When p2=Scale

Syntax MP p1,p2,p3,p4,p5,p6,p7,p8,p9,p10,p11,p12<terminator>

p1: Control input channel numbers (CI01–CI10, or CI01–CI05 for the CX1000)
 p2: Mode (Scale)
 p3: Type (DCV, TC, RTD)
 p4: Measuring range designation
 p3=DCV (20 mV, 60 mV, 200 mV, 2 V, 6 V, 20 V, 50 V)
 p3=TC(R,S,B,K,E,J,T,N,W,L,U,PLATI,PR, WRe)
 p3=RTD(JPT,PT)
 p5: Span lower limit EU(0.0–100.0%)
 p6: Span upper limit EU(0.0–100.0%)
 p7: Scale lower limit (-30000–30000)
 p8: Scale upper limit (-30000–30000)
 p7-p8≤30000
 p9: Decimal point position (0–4)
 p10: Unit (max 6 characters)
 p11: Enable/disable square root computation (Off, On)
 p12: Low-cut value (0.0% to 5.0%)

Query MP[p1]?

Example The voltage measured with CI02 is converted to units of mV. The measuring range is set to 2 V, lower limit of span to -2 V, upper limit of span to 2 V, scaling lower limit value to -2000 mV, scaling upper limit value to 2000 m, and low signal cutoff value to 0%.
 MPC102,SCALE,DCV,2V,-2000,2000,-2000,2000,0,mV,ON,0

Description Valid when PV/SP computation function is ON.

MB Bias

When the PV/SP Computation Function is OFF

Syntax MB p1,p2,p3,p4<terminator>
 p1: Loop number (1 to 6) (1 or 2 on the CX1000)
 p2: Input type (PV1, PV2, RemoteSP)
 Note) RemoteSP is valid only when using remote.
 p3: Enable/disable bias (Off, On)
 p4: Bias value EUS (-100.0 to 100.0%)
Query MB[p1,p2]?
Example Set the bias of loop 1 PV1 (whose input type is set to TC type E) to the minimum value.
 MB1,PV1,ON,-10000

When the PV/SP Computation Function is ON

Syntax MB p1,p2,p3<terminator>
 p1: Control input channel numbers (CI01–CI10, or CI01–CI05 with the CX1000)
 p2: Bias (Off, On)
 p3: Bias value EUS(-100.0-100.0%)
Query MB[p1]?
Example Set the CI02 bias, input type of thermocouple E, to the minimum value.
 MB102,ON,-10000

MF Filter**When the PV/SP Computation Function is OFF**

Syntax MF p1 , p2 , p3 , p4<terminator>
 p1: Loop number (1 to 6) (1 or 2 on the CX1000)
 p2: Input type (PV1, PV2, RemoteSP)
 Note) RemoteSP is valid only when using remote.
 p3: Enable/disable filter (Off, On)
 p4: Filter value (0 to 120 s)

Query MF[p1 , p2]?
 Example Set the filter value of loop 1 PV1 to 60 s.
 MF1 , PV1 , ON , 60

When the PV/SP Computation Function Is ON

Syntax MF p1 , p2 , p3<terminator>
 p1: Control input channel numbers (CI01-CI10, or CI01-CI05 with the CX1000)
 p2: Filter (Off, On)
 p3: Filter value (0-120s)

Query MF[p1]?
 Example Set CI03's filter value to 60 seconds.
 MF CI03 , ON , 60

RS Set the ratio

Syntax RS p1 , p2 , p3 , p4<terminator>
 p1: Loop number (1 to 6) (1 or 2 on the CX1000)
 p2: Enable/disable ratio setting (Off, On)
 p3: Ratio value (0.001 to 9.999)
 p4: Rtio decimal point position (0-4)

Query RS[p1 , p2]?
 Example Set the ratio value of loop 2 to 1.000.
 RS2 , ON , 1000

Description Valid when remote input is selected with the GS command.

Control Alarm**AT Sets the control alarm****When p3=Off (no control alarm)**

Syntax AT p1 , p2 , p3<terminator>
 p1: Loop number (1 to 6) (1 or 2 on the CX1000)
 p2: Alarm number (1 to 4)
 p3: Enable/disable alarm setting (Off)

Query AT[p1 , p2]?
 Example Turn off loop 1 number 1 alarm.
 AT1 , 1 , OFF

When p1=1 to 6**When p3=On (with control alarm)**

Syntax AT p1 , p2 , p3 , p4 , p5 , p6 , p7<terminator>
 p1: Loop number (1 to 6) (1 or 2 on the CX1000)
 p2: Alarm number (1 to 4)
 p3: Enable/disable alarm setting (On)
 p4: Alarm type*1
 p5: Alarm standby (Off, On)
 p6: Enable/disable relay setting (Off, On)

p7: Relay number*2
 *1: PV-High,PV-Low,Deviation-High, Deviation-Low,Deviation-H&L, Dev-within-H&L,SP-High,SP-Low, Output-High,Output-Low
 *2: DI001 to DI006
 DI101 to DI106
 DI201 to DI206
 RI001 to RI012 (expansion module)

Query AT[p1 , p2]?
 Example Set loop 1 alarm number 4 as follows: Type: deviation high/low limits alarm, standby and relay output: On, activate relay 104 when alarms occur.
 AT1 , 4 , ON , DEVIATION-H&L , ON , ON , DO104

AV Sets the control alarm value**When p1=1 to 6**

Syntax AV p1 , p2 , p3 , p4<terminator>
 p1: Loop number (1 to 6) (1 or 2 on the CX1000)
 p2: SP number 1 to 8
 p3: Alarm number (1 to 4)
 p4: Alarm value
 PV/SP alarm EU (0.0 to 100.0%)
 Deviation high or deviation low limit alarm EUS (-100.0 to 100.0%)
 Deviation high/low limit alarm or within deviation high and low limit alarm EUS (0.0 to 100.0%)
 Output value alarm (-5.0 to 105.0%)

Query AV[p1 , p2 , p3]?
 Example Set the alarm value of loop 1 SP number 1 alarm number 1 (whose input type is set to TC type K and alarm number 1 type set to deviation high limit alarm) to the maximum value within the selectable range.
 AV1 , 1 , 1 , 15700

Operation-related Parameters**HS Sets the suppressing function**

Syntax HS p1 , p2<terminator>
 p1: Loop number (1 to 6) (1 or 2 on the CX1000)
 p2: Suppressing function (Off, Overshoot)

Query HS[p1]?
 Example Set the suppressing function of loop 1.
 HS1 , OVERSHOOT

HT Sets the ramp-rate-time unit

Syntax HT p1 , p2<terminator>
 p1: Loop number (1 to 6) (1 or 2 on the CX1000)
 p2: Ramp-rate-time unit (Hour, Minute, Second)

Query HT[p1]?
 Example Set the ramp-rate-time unit of loop 1 to "Second."
 HT1 , SECOND

6.4 Setting Commands (Control)

HH Sets the SP ramp-up-rate

Syntax HH p1 , p2 , p3<terminator>
p1: Loop number (1 to 6) (1 or 2 on the CX1000)
p2: Enable/disable SP ramp-up-rate setting (Off, On).
p3: SP ramp-up-rate value (1 digit to EUS (100%))

Query HH[p1]?
Example Set the SP ramp-up-rate of loop 1 (whose input type is set to RTD type PT) to the maximum value in the selectable range.
HH1 , ON , 8000

HL Sets the SP ramp-down-rate

Syntax HL p1 , p2 , p3<terminator>
p1: Loop number (1 to 6) (1 or 2 on the CX1000)
p2: Enable/disable SP ramp-down-rate setting (Off, On).
p3: SP ramp-down-rate value (1 digit to EUS (100%))

Query HL[p1]?
Example Set the SP ramp-down-rate of loop 2 (whose scale range is set to 100.00 to 200.00) to the minimum value in the selectable range.
HL2 , ON , 1

HM Sets the loop tag and tag comment

Syntax HM p1 , p2<terminator>
p1: Loop number (1 to 6) (1 or 2 on the CX1000)
p2: Tag (8 alphanumeric characters.)
p3: Tag comment (8 alphanumeric characters.)

Query HM[p1]?
Example Set the tag of loop 5 to "TAG5", and tag comment to "LP5 Tag".
HM5 , TAG5 , LP5 Tag

GC Zone PID setting 1 (reference points)

Syntax GC p1 , p2 , p3<terminator>
p1: Loop number (1 to 6) (1 or 2 on the CX1000)
p2: Reference point number (1 to 6)
p3: Reference point EU (0.0 to 100.0%)
Number of reference points = PID group number - 2

Query GC[p1 , p2]?
Example Set the reference point 1 of loop 4 (whose input type is set to TC type J) to the minimum value in the selectable range.
GC4 , 1 , -2000

GD Zone PID setting 2 (switching hysteresis)

Syntax GD p1 , p2<terminator>
p1: Loop number (1 to 6) (1 or 2 on the CX1000)

p2: Switching hysteresis value EUS (0.0 to 10.0%)

Query GD[p1]?
Example Set the switching hysteresis of loop 3 (whose input type is set to TC type R) to the maximum value in the selectable range.
GD3 , 1760

HW Zone PID setting 3 (reference deviation)

Syntax HW p1 , p2 , p3<terminator>
p1: Loop number (1 to 6) (1 or 2 on the CX1000)
p2: Enable/disable reference deviation (Off, On)
p3: Reference deviation value (1 digit to EUS (100%))

Query HW[p1]?
Example Set the reference deviation of loop 2 (whose input type is set to TC type WRe) to the maximum value in the selectable range.
HW1 , ON , 24000

PID Parameters

GO Sets the target setpoint

Syntax GO p1 , p2 , p3<terminator>
p1: Loop number (1 to 6) (1 or 2 on the CX1000)
p2: PID number (1 to 8)
p3: Target setpoint EU (0.0 to 100.0%)
Except, within the target setpoint high and low limits.

Query GO[p1 , p2]?
Example Set the target setpoint of PID number 1 of loop 1 (whose input type is set to TC type PLATI) to the maximum value in the selectable range.
GO1 , 1 , 14000

HP Sets the proportional band

Syntax HP p1 , p2 , p3<terminator>
p1: Loop number (1 to 6) (1 or 2 on the CX1000)
p2: PID number (1 to 8)
p3: Proportional band P (0.1 to 999.9%)

Query HP[p1 , p2]?
Example Set the proportional band of PID number 6 of loop 2 to 100.0%.
HP2 , 6 , 1000

HI Sets the integral time

Syntax HI p1 , p2 , p3<terminator>
p1: Loop number (1 to 6) (1 or 2 on the CX1000)
p2: PID number (1 to 8)
p3: Integral time (0 to 6000 s)

Query HI[p1 , p2]?
Example Set the integral time of PID number 8 of loop 3 to 3600 s.
HI3 , 8 , 3600

HD Sets the derivative time

Syntax HD p1,p2,p3<terminator>
 p1: Loop number (1 to 6) (1 or 2 on the CX1000)
 p2: PID number (1 to 8)
 p3: Derivative time (0 to 6000 s)

Query HD[p1,p2]?

Example Set the derivative time of PID number 1 of loop 4 to 900 s.
 HD4,1,900

HO Sets control-related parameters**4-20mA Current Output**

Syntax HO p1,p2,p3,p4,p5,p6,p7,p8<terminator>
 p1: Loop number (1 to 6) (1 or 2 on the CX1000)
 p2: PID number (1 to 8)
 p3: Output low-limit (–5.0 to 105.0%)
 p4: Output high-limit (–5.0 to 105.0%)
 P4>P3
 p5: Enable/Disable the shutdown function (Off, On)
 p6: Manual reset (–5.0 to 105.0%)
 p7: Control action direction (Reverse, Direct)
 p8: Preset output (–5.0 to 105.0%)
 (valid only on the secondary side for cascade control)

Query HO[p1,p2]?

Example Set PID number 7 of loop 3 as follows: output low-limit: –1.0%, output high-limit: 101.0%, shutdown function: disabled, manual reset: 80.0%, control action direction: direct, preset output: 10.0%.
 HO3,7,-10,1010,OFF,800,DIRECT,100

ON/OFF Control

Syntax HO p1,p2,p3,p4,p5,p6,p7,p8,p9 <terminator>
 p1: Loop number (1 to 6) (1 or 2 on the CX1000)
 p2: PID number (1 to 8)
 p3: Hysteresis setting EUS (0.0 to 100.0%)
 p4: Hysteresis activation point (Mid, High, Low)
 p5: Control action direction (Reverse, Direct)
 p6: Preset output (–5.0 to 105.0%)
 (valid only on the secondary side for cascade control)

Query HO[p1,p2]?

Example Set PID number 4 of loop 4 (whose input type is set to TC type T) as follows: relay hysteresis: 10% (60.0) of the selectable range, activation point: high, control action direction: reverse, preset output: 0.0%.
 HO4,4,600,HIGH,REVERSE,0

No ON/OFF Control

Syntax HO p1,p2,p3,p4,p5,p6,p7<terminator>
 p1: Loop number (1 to 6) (1 or 2 on the CX1000)
 p2: PID number (1 to 8)
 p3: Output low-limit (–5.0 to 105.0%)
 p4: Output high-limit (–5.0 to 105.0%)
 p5: Manual reset (–5.0 to 105.0%)
 p6: Control action direction (Reverse, Direct)
 p7: Preset output (–5.0 to 105.0%)
 (valid only on the secondary side for cascade control)

Query HO[p1,p2]?

Example Set PID number 5 of loop 5 as follows: output low-limit: 10.0%, output high-limit: 90.0%, manual reset: 10.0%, control action direction: reverse, preset output: 50.0%.
 HO5,5,100,900,100,DIRECT,500

Control Group Setting FG Sets the control group name

Syntax FG p1,p2<terminator>
 p1: Group number (1 to 8) (1 to 4 on the CX1000)
 p2: Group name (up to 16 characters)

Query FG[p1]?

Example Set the group name of group number 2 to “CONTROL No. 2”.
 FG2,CONTROL No.2

GG Sets the control group

Syntax GG p1,p2,p3,p4,p5<terminator>
 p1: Group number (1 to 8) (1 to 4 on the CX1000)
 p2: Item number (1 to 6)
 p3: Off/On
 p4: Item type (Kind)
 (Int-Loop/Ext-Loop/Meas-CH)
 p5: Loop number
 (Internal loop: 1 to 6) (1 or 2 on the CX1000)
 (External loop: 1 to 16) (1 to 4 on the CX1000)
 (Meas. CH: 1 to 20) (1 to 6 on the CX1000)
 (DIO: 1 to 36) (1 to 12 on the CX1000)

Query GG[p1,p2]?

Example Set group number 6 item number 1 to internal loop 1.
 GG6,1,ON,INT-LOOP,1

6.4 Setting Commands (Control)

HA Sets the ten-segment linearizer mode

When the PV/SP Computation Function is OFF

Syntax HA p1 , p2 , p3 <terminator>
p1: Loop number (1 to 6) (1 or 2 on the CX1000)
p2: Input type (PV1, PV2)
p3: Ten-segment linearizer mode (Off, Biasing, and Approximation)

Query HA[p1 , p2]?

Example Set the ten-segment linearizer mode of loop 6 PV1 to ten-segment linearizer bias.
HA6 , PV1 , BIASING

When the PV/SP Computation Function Is ON

Syntax HA p1 , p2 <terminator>
p1: Control input channel numbers (CI01–CI10, or CI01–CI05 for the CX1000)
p2: Ten segment linearizer mode (Off, Biasing, and Approximation)

Query HA[p1]?

Example The ten segment linearizer mode of CI01 is set to ten segment linearizer bias.
HACI01 , BIASING

HE Sets the ten-segment linearizer segment

When the PV/SP Computation Function is OFF

Syntax HE p1 , p2 , p3 , p4 , p5 <terminator>
p1: Loop number (1 to 6) (1 or 2 on the CX1000)
p2: Input type (PV1, PV2)
p3: Segment number (1 to 11)
p4: Ten-segment linearizer input
Ten-segment linearizer approximation
EU(-5.0 to 105.0%)
Ten-segment linearizer bias
EU(-5.0 to 105.0%)
p5: Ten-segment linearizer output
Ten-segment linearizer approximation
EU(-5.0 to 105.0%)
Ten-segment linearizer bias
EUS (-100.0 to 100.0%)

Query HE[p1 , p2 , p3]?

Example Set the PV1 of loop 1 (whose input type is set to RTD type JPT and ten-segment linearizer mode set to ten-segment linearizer bias) as follows: ten-segment linearizer input of segment number 2: 500.0, output: maximum value in the selectable range.
HE1 , PV1 , 2 , 5000 , 875

When PV/SP Computation Function is ON

Syntax HE p1 , p2 , p3 , p4 <terminator>
p1: Control input channel numbers (CI01–CI10, or CI01–CI05 for the CX1000)
p2: Ten segment linearizer number (1–11)
p3: Ten segment linearizer input
Ten segment linearizer approximation
EU(-5.0-105.0%)
Ten segment linearizer bias
EU(-5.0-105.0%)
p4: Ten segment linearizer output
Ten segment linearizer approximation
EU(-5.0-105.0%)
Ten segment linearizer bias
EUS(-100.0-100.0%)

Query HE[p1 , p2]?

Example Set the CI01 (whose input type is set to RTD type JPT and ten-segment linearizer mode set to ten-segment linearizer bias) as follows: ten-segment linearizer input of segment number 2: 500.0, output: maximum value in the selectable range.
HECI01 , 2 , 5000 , 7750

PB Sets initial pattern

Syntax PB p1 , p2 , p3 , p4 , p5 , p6 <terminator>
p1: Pattern number (1 to 30)
p2: Used segments (0 to 99). However, the total number of segments used in all patterns must be 300 or less.
p3: Segment setting method (Time, Ramp)
p4: Pattern name (up to 16 alphanumeric characters.)
p5: Edit segment (Off/Delete/Insert)
Can be specified only when P2 is not 0.
p6: Edit segment number (1 to 99). However, within the number of used segments. Can be specified only when p5 is not off.

Query PB[p1]?

Description

- When program control is in execution, p1 and p2 are pattern number and pattern name, respectively. Other parameters cannot be set.
- When the setup data file is being output (specified using the FE command), this command cannot be used.

PI Operating loop designation

Syntax PI p1 , p2 <terminator>
p1: Loop number (1–6, or 2 on the CX1000)
p2: Operation designation (On/Off)

Query PI[p1]?

Wait Action Setting**PZ Sets the wait zone**

Syntax PZ p1 , p2 , p3 , p4 , p5<terminator>
 p1: Loop number (1 to 6) (1 or 2 on the CX1000)
 p2: Wait zone number (1 to 5)
 p3: Wait Off/On
 p4: High boundary of the zone (1 digit to EUS (100.0%))
 p5: Low boundary of the zone (1 digit to EUS (100.0%))
 p4 and p5 can be specified only when p3 is ON.

Query PZ[p1 , p2]?

PW Sets the wait time

Syntax PW p1 , p2<terminator>
 p1: Wait zone number (1 to 5).
 p2: Wait-time setting (hh:mm:ss fixed format)
 hh Hour (00 to 99)
 mm Minute (00 to 59)
 ss Second (00 to 59)

Query PW[p1]?

Program Initial Setting**PO Sets the start setpoint**

Syntax PO p1 , p2<terminator>
 p1: Loop number (1 to 6) (1 or 2 on the CX1000)
 p2: Start target setpoint EU (0.0 to 100.0%)

Query PO[p1]?

PQ Sets the start code

Syntax PQ p1<terminator>
 p1: Start code*
 *: StartTargetSP
 RampPV1Start
 TimePVStart
 RampPV2Start
 RampPV3Start
 RampPV4Start
 RampPV5Start
 RampPV6Start

Query PQ?

Program Operation Parameters**PD Sets the ramp/soak select**

Syntax PD p1 , p2<terminator>
 p1: Segment number (1 to 99)
 p2: Ramp/soak selection (Ramp/Soak)

Query PD[p1]?

PM Sets the final target setpoint

Syntax PM p1 , p2 , p3<terminator>
 p1: Segment number (1 to 99)
 p2: Loop number (1 to 6) (1 or 2 on the CX1000)
 p3: Final target setpoint EU (0.0 to 100.0%)

Query PM[p1 , p2]?

PT Sets the segment time

Syntax PT p1 , p2<terminator>
 p1: Segment number (1 to 99)
 p2: Segment time (hh:mm:ss fixed format)
 hh Hour (00 to 99)
 mm Minute (00 to 59)
 ss Second (00 to 59)
 Set a value greater than or equal to 1 s.

Query PT[p1]?

PU Sets the ramp-rate time unit/ramp

Syntax PU p1 , p2 , p3<terminator>
 p1: Segment number (1 to 99)
 p2: Ramp-rate time unit (Hour, Minute)
 p3: Ramp (ramp per unit time 1 digit to EUS (100%))

Query PU[p1]?

PG Segment PID group number

Syntax PJ p1 , p2<terminator>
 p1: Segment number (1 to 99)
 p2: Segment PID group number (1 to 8)

Query PG[p1]?

PJ Sets the segment shifting action and wait

Syntax PJ p1 , p2 , p3 , p4<terminator>
 p1: Segment number (1 to 99)
 p2: Segment shifting action*
 p3: Wait (Off/Shift/Within)
 p4: Wait zone number (1 to 5) (selectable only when p3 is set to Shift or Within)
 *:Continue/HoldShift/LocalShift/ResetShift

Query PJ[p1]?

Event Setting**ET Sets the time event**

Syntax ET p1 , p2 , p3 , p4 , p5<terminator>
 p1: Segment number (1 to 99)
 p2: Event number (1 to 16)
 p3: Enable/disable event (Off, On1, On2, On3)
 p4: On-time (hh:mm:ss fixed format)
 hh Hour (00 to 99)
 mm Minute (00 to 59)
 ss Second (00 to 59)
 p5: Off-time (hh:mm:ss fixed format)
 hh Hour (00 to 99)
 mm Minute (00 to 59)
 ss Second (00 to 59)
 P5>P4

Query ET[p1 , p3]?

6.4 Setting Commands (Control)

- Description
- When p3 is set to On1, p4 and p5 are handled as On-time and Off-time, respectively.
 - When p3 is set to On2, p4 is handled as On-time. p5 is void.
 - When p3 is set to On3, p4 is handled as Off-time. p5 is void.

EP Sets the PV event

Syntax EP p1 , p2 , p3 , p4 , p5<terminator>
p1: Segment number (1 to 99)
p2: Event number (1 to 16)
p3: Loop number
(Off, 1 to 6 (1 or 2 on the CX1000))
p4: PV event type*
p5: PV event value (Set a percentage value for output events)
*: PV-High, PV-Low, Deviation-High, Deviation-Low, Deviation-H&L, Dev-within-H&L, SP-High, SP-Low, Output-High, Output-Low

Query EP[p1 , p2]?

Event Output Setting **EO** Sets the event output

Syntax ET p1 , p2 , p3 , p4<terminator>
p1: Event kind (TimeEvent, PVEvent)
p2: Event number (1 to 16)
p3: Enable/disable relay output (Off, On)
p4: Relay number*
*: DO001 to DO006
DO101 to DO106
DO201 to DO206
RO001 to RO012 (Expansion module)
SW001 to SW036 (Internal switch)
On the CX1000: DO001 to DO006,
SW001 to SW018

Query EO[p1 , p2]?

PA Program pattern end signal

Syntax PA p1 , p2<terminator>
p1: Enable/disable relay output (Off, On)
p2: Relay number*
*: DO001 to DO006
DO101 to DO106
DO201 to DO206
RO001 to RO012 (expansion module)
SW001 to SW036 (Internal switch)
On the CX1000: DO001 to DO006,
SW001 to SW018

Query PA?

Repeat Action Setting **PR** Sets the repeating action

Syntax PR p1 , p2 , p3 , p4<terminator>
p1: Repeating action (Off, On, Repeat)
p2: Repeating frequency (1 to 999). Can be specified only when p1 is On.
p3: Repeat-start segment number (1 to 99)
p4: Repeat-end segment number (1 to 99)

Query PR?

Description When p1 is set to Repeat, p2 and p3 are repeat-start segment number and repeat-end segment number, respectively.

Program End **PE** End programming

Syntax PE p1<terminator>
p1: 0: STORE (end programming)
1: ABORT (abort programming)

Auto message for program Run/Reset **PK** Sets the auto message for program Run/Reset

Syntax PK p1<terminator>
p1: 0: Off (Disable auto message)
1: On (Enable auto message)

Query PK?

Program display position **PL** Sets the program display position

Syntax PL p1 , p2<terminator>
p1: Loop number (1 to 6) (1 or 2 on the CX1000)
p2: Display position (1 to 6)

Auto change to program run display **MQ** Sets the operation display automatic switching

Syntax MQ p1<terminator>
p1: Turns operation display automatic switching On/Off

Query MQ?

Event Display Group **PV** Sets the event display group

Syntax PV p1 , p2 , p3 , p4 , p5<terminator>
p1: Pattern number (1–30)
p2: Event display number (1–5)
p3: Display ON/OFF
p4: Event types
Time Event: Time events
PV Event: PV events
p5: Event number (1–16)

Query PV[p1]?

Detail Settings (Control Function Settings)**HF Sets the setpoint**

Syntax HF p1 , p2 , p3 , p4 , p5<terminator>
 p1: Loop number (1 to 6) (1 or 2 on the CX1000)
 p2: Enable/disable SP tracking (Off, On).
 p3: Enable/disable PV tracking (Off, On).
 p4: SP high-limit EU (0.0 to 100.0%)
 High-limit > Low-limit
 p5: SP low-limit EU (0.0 to 100.0%)
 High-limit > Low-limit

Query HF[p1]?

GL Sets the output velocity limiter

Syntax GL p1 , p2 , p3<terminator>
 p1: Loop number (1 to 6) (1 or 2 on the CX1000)
 p2: Enable/disable output velocity limiter (Off, On)
 p3: Output velocity limiter value (0.1 to 100.0%/s)

Query GL[p1]?

Description This command cannot be used when the control output type (set using the GQ command) is set to "On/Off-control."

GA Sets the anti-reset windup function

Syntax GA p1 , p2 , p3<terminator>
 p1: Loop number (1 to 6) (1 or 2 on the CX1000)
 p2: Anti-reset windup function (Auto, Manual)
 p3: Deviation width (50.0 to 200.0)
 Can be specified only when p2 is set to Manual.

Query GA[p1]?

Description This command cannot be used when the control output type (set using the GQ command) is set to "On/Off-control."

Detail Settings (Hysteresis (Alarm, PV Event))**AP Sets the alarm hysteresis**

Syntax AP p1 , p2 , p3<terminator>
 p1: Loop number (1 to 6) (1 or 2 on the CX1000)
 p2: Alarm number (1 to 4)
 p3: Hysteresis EUS (The hysteresis range is the range of values that results from multiplying the measurement span by 0.0 to 10.0%. However, when the alarm type is output high-limit or output low-limit, the range is 0.0 to 10.0% as-is.)

Query AP[p1 , p2]?

PH Sets the PV event hysteresis

Syntax PH p1 , p2<terminator>
 p1: PV event number (1 to 16)
 p2: Hysteresis (0.0 to 10.0%)

Query PH[p1]?

Detailed Settings (DIO Operation Monitoring Function Settings)
DX DIO operation monitoring function settings**When DIO operation monitoring function is OFF**

Syntax DX p1 , p2<terminator>
 p1: DIO operation monitoring function number (01–36, 01–12 for the CX1000)
 p2: Off(Off/On)

Query DX p1?

Example When DIO operation monitoring number 2 is OFF
 DX2 , OFF

When set to DI-1

Syntax DX p1 , p2 , p3 , p4<terminator>
 p1: DIO operation monitoring function number (01–36, 01–12 for the CX1000)
 p2: ON(Off/On)
 p3: Type (DI-1, DO-1, DO-2, DIO-11, DIO-12, DO-2P, DIO-12P)
 Set to DI-1 here.
 p4: DI number (DI001-DI006, DI101-DI106, DI201-DI206, RI001-RI012, or DI001-DI006 for the CX1000)

Query DX p1?

Example Set DIO operation monitoring number 2 so that it monitors DI002 input.
 DX2 , ON , DI-1 , DI002

When set to DO-1

Syntax DX p1 , p2 , p3 , p4 , p5<terminator>
 p1: DIO operation monitoring function number (01–36, 01–12 for the CX1000)
 p2: ON(Off/On)
 p3: Type (DI-1, DO-1, DO-2, DIO-11, DIO-12, DO-2P, DIO-12P)
 Set to DO-1 here.
 p4: Internal switch number (SW001-SW036, or SW001-SW018 for the CX1000)
 p5: DO number (DI001-DI006, DI101-DI106, DI201-DI206, RI001-RI012, or DI001-DI006 for the CX1000)

Query DX p1?

Example Set DIO operation monitoring number 2 so that the status of internal switch SW003 is output from DO002, and monitored.
 DX2 , ON , DO-1 , SW003 , DO002

When set to DO-2 or DO-2P

Syntax DX p1 , p2 , p3 , p4 , p5 , p6<terminator>
 p1: DIO operation monitoring function number (01–36, 01–12 for the CX1000)
 p2: ON(Off/On)
 p3: Type (DI-1, DO-1, DO-2, DIO-11, DIO-12, DO-2P, DIO-12P)
 Set to DO-2 or DO-2P here.

6.4 Setting Commands (Control)

p4: Internal switch number (SW001-SW036, or SW001-SW018 for the CX1000)

p5: ON DO number (DI001-DI006, DI101-DI106, DI201-DI206, RI001-RI012, or DI001-DI006 for the CX1000)

p6: OFF DO number (DI001-DI006, DI101-DI106, DI201-DI206, RI001-RI012, or DI001-DI006 for the CX1000)

Query DX p1?

Example Set DIO operation monitoring number 2 so that the ON status of internal switch SW003 is output from DO002, and the OFF status is output from DO003, and monitored.

`DX2,ON,DO-2,SW003,DO002,DO003`

When set to DIO-11

Syntax DX p1,p2,p3,p4,p5,p6<terminator>

p1: DIO operation monitoring function number (01-36, 01-12 for the CX1000)

p2: ON(Off/On)

p3: Type (DI-1, DO-1, DO-2, DIO-11, DIO-12, DO-2P, DIO-12P)
Set to DIO-11 here.

p4: Internal switch number (SW001-SW036, or SW001-SW018 for the CX1000)

p5: DO number (DI001-DI006, DI101-DI106, DI201-DI206, RI001-RI012, or DI001-DI006 for the CX1000)

p6: DI number (DI001-DI006, DI101-DI106, DI201-DI206, RI001-RI012, or DI001-DI006 for the CX1000)

Query DX p1?

Example Set DIO operation monitoring number 2 to so that the status of internal switch SW003 is output from DO002, and DIO03's status is monitored.

`DX2,ON,DIO-11,SW003,DO002,DI003`

When set to DIO-12 or DIO-12P

Syntax DX p1,p2,p3,p4,p5,p6,p7<terminator>

p1: DIO operation monitoring function number (01-36, 01-12 for the CX1000)

p2: ON(Off/On)

p3: Type (DI-1,DO-1, DO-2, DIO-11, DIO-12, DO-2P, DIO-12P)
Set to DIO-12 or DIO-2P here.

p4: Internal switch number (SW001-SW036, or SW001-SW018 for the CX1000)

p5: ON DO number (DI001-DI006, DI101-DI106, DI201-DI206, RI001-RI012, or DI001-DI006 for the CX1000)

p6: OFF DO number (DI001-DI006, DI101-DI106, DI201-DI206, RI001-RI012, or DI001-DI006 for the CX1000)

p7: DI number (DI001-DI006, DI101-DI106, DI201-DI206, RI001-RI012, or DI001-DI006 for the CX1000)

Query DX p1?

Example Set DIO operation monitoring number 2 so that the ON status of internal switch SW003 is output from DO002, the OFF status is output from DO003, and DIO02's status is monitored.

`DX2,ON,DIO-12,SW003,DO002,DO003,DI002`

Description With DO-2, DO-2P, DIO-12, and DIO-12P, ON DO and OFF DO cannot be set to the same DO.

DY Sets the DIO operation monitoring function tag and tag comment

Syntax DX p1,p2,p3<terminator>

p1: DIO operation monitoring function number (01-36, 01-12 for the CX1000)

p2: Tag (8 alphanumeric characters, no symbols)

p3: Tag comment (8 alphanumeric characters, no symbols)

Query DX[p1]?

Example Set DIO operation monitoring function number 3's tag to test, and the tag comment to onoff.

`DX3,test,onoff`

DZ Sets the DIO operation monitoring function label and display color

Syntax DZ p1,p2,p3,p4,p5<terminator>

p1: DIO operation monitoring function number (01-36, 01-12 for the CX1000)

p2: ON label (8 alphanumeric characters, no symbols)

p3: ON display color
Red, Green, B.violet, Brown, Orange, Y.green, Lightblue, Violet, Lime, Cyan, Darkblue, Purple

p4: OFF label (8 alphanumeric characters, no symbols)

p5: OFF display color
Red, Green, B.violet, Brown, Orange, Y.green, Lightblue, Violet, Lime, Cyan, Darkblue, Purple

Query DZ[p1]?

Example Set DIO operation monitoring function number 3's ON label to start, the ON display color to red, the OFF label to stop, and the OFF display color to green.

`DZ3,start,Red,stop,Green`

Detailed Settings (DI/DO Label Settings) **DW** Sets the DI/DO label

Syntax	DW p1,p2,p3<terminator> p1: DI/DO types CTRL1-DO, CTRL2-DO, CTRL3-DO, EXT1-RO, CTRL1-DI, CTRL2-DI, CTRL3-DI, EXT1-RI p2: DIO terminal number DI001-DI006, DI101-DI106, DI201-DI206, RI001-RI012, DO001-DO006, DO101-DO106, DO201-DO206, RO001-RO012 p3: Label (16 alphanumeric characters, no symbols)
Query	DW[p1,p2]?

Control Computation **MT** Sets the Equation

PV computation settings

Syntax	MT p1,p2,p3,p4,p5,p6,p7,p8 (,p9,p10) <terminator> p1: Loop number (1–6, or 2 on the CX1000) p2: Parameters set for equations (PV/PV1/PV2) p3: Turn On/Off computation p4: Equation (max 120 characters) p5: PV range lower limit (-30000–30000, width 30000) p6: PV range upper limit (-30000–30000, width 30000) p7: Range decimal point position (0–4) p8: Unit (max 6 characters) p9: Input switching PV lower limit value (2 input switching only. However, the switching conditions are -30000–30000 for the upper limit value, within the p5 and p6 range). p10: Input switching PV lower limit value (2 input switching only, however, the switching conditions are invalid for the upper limit value, -30000–30000, within the p5 and p6 range).
--------	--

SP computation settings

Syntax	MT p1,p2,p3,p4<terminator> p1: Loop number (1–6, or 2 on the CX1000) p2: Parameters set for equations (Sp) p3: Turn On/Off computation p4: Equation (max 120 characters)
--------	--

Analog retransmission computation settings

Syntax	MT p1,p2,p3,p4,p5,p6,p7,p8<terminator> p1: Loop number (1–6, or 2 on the CX1000) p2: Parameters set for equations (Retrans) p3: Turn On/Off computation p4: Equation (max 120 characters) p5: OUT span lower limit(-30000–30000, width 30000)
--------	--

p6: OUT span upper limit (-30000–30000, width 30000)
p7: OUT span decimal point position (0–4)
p8: Unit (max 6 characters)

Query	MT[p1]?
Example	Set the average value of the measured values from channels 02–05 to loop 1's PV. The lower limit value of the PV range is 1 V, and 5 V for the upper limit value. MT01,PV,ON,CLOG.AVE(02-05),100,500,2,V
Description	Supports CX style number S3 or later. If the p3 equation cannot be set, fill in order from p4.

MU Computation error settings

Syntax	MU p1,p2,p3<terminator> p1: Loop number (1–6, or 2 on the CX1000) p2: Parameters (PV/PV1/PV2/SP/Retrans) p3: Error designation (Over/Under)
Query	MU[p1]?

MV Sets the logic computation

Syntax	MV p1,p2<terminator> p1: Computation number (1–30) p2: Output relay selection OFF/DO001-DO006/DO101-DO106/DO201-DO206/RO001-RO012/SW001-SW036 p3: Equation (unnecessary when p2 is OFF, up to 120 characters)
Query	MV[p1]?

MX Sets the computation constant

Syntax	MX p1,p2<terminator> p1: Computation constant number (1–36) p2: Computation constant -9.9999E+29 to -1.0000E-30 0 1.0000E-30 to 9.9999E+29
Query	MX[p1]?

DU Sets the remote bias

Syntax	DU p1,p2,p3<terminator> p1: Loop number (1–6, or 2 on the CX1000) p2: Turn On/Off bias p3: Bias value (-30000–30000)
Query	DU[p1]?

6.5 Setting Commands (Measurement)

External Loop PID Parameter Settings DT Sets the external loop PID parameter

Syntax	DT p1 , p2 , p3 , p4 <terminator> p1: Loop number (1–16, or 1–4 on the CX1000) p2: Loop number 1–4 for UT320/UT321/UT350/UT351 1–8 for UT420/UT450/UT520/UT550/UT750 p3: PID parameter name SP: target setpoint (EU(0.0–100.0%)) A1-A4: Alarm 1–4 setting value (or alarm 1–3 for the UT320/UT321/UT350/UT351/UT420) Measured value alarm/setting value alarm: measured input range of -100.0–100.0% Deviation alarm: measured input range span of -100.0–100.0% Output value alarm: -5.0–105.0% Time alarm (alarm 1 only): -1–5999 P: Proportional band setting (1–9999) OH: Output limit upper limit value (-5.0–105.0%) OL: Output limit lower limit value (-5.0–105.0%) MR: Manual reset (-5.0–105.0%) (Active when integral time I is OFF) H: On/off control hysteresis During On/off control: Measured input range span of -100.0–100.0% During position proportional PID control: 0.0–100.0% DB: Dead band During position proportional PID control: 1.0–10.0% DR: Correct back switching operation [2] 0: Back, 1: Right action [2] PO: Preset output value (-5.0–105.0%) For loops set to the CX's external loop tuning item, the external loop tuning items take precedence. p4: Parameter value Measured value varies depending on p3's PID parameter.
Query	DT[p1 , p2 (, p3)] ?
Example	Set external loop 1, group number 1, and PID parameter SP to 1000. DT1 , 1 , SP , 1000
Description	<ul style="list-style-type: none"> The parameter setting range differs depending on the UT used. p4 is not needed for the UT320, UT321, UT350, UT351, and UT420.

Integral time/derivative time settings

Syntax	DT p1 , p2 , p3 , p4 , p5 <terminator> p1: Loop number (1–16, or 1–4 on the CX1000) p2: Loop number 1–4 for UT320/UT321/UT350/UT351 1–8 for UT420/UT450/UT520/UT550/UT750 p3: PID parameter name I: Integral time D: Derivative time p4: Turns integration/differentiation On/Off p5: Parameters when p4 is ON (1–6000)
Query	DT[p1 , p2 (, p3)] ?
Example	Set external loop 2, group number 2, and PID parameter D to 2000. DT2 , 2 , D , ON , 2000
Description	<ul style="list-style-type: none"> Given the query, DT p1 , p2?, returns the PID parameter for p2's group number and the setting values of each parameter. The PID parameters that can be set vary depending on the control mode of the external groups, and the control output type. On/off control: SP, A1-A4, H, DR, PO Other than On/off control SP, A1-A4, P, I, D, OH, OL, MR, DR, PO Position proportional control SP, A1-A4, H, P, I, D, OH, OL, MR, DR, DB, PO Internal switches primary SP, A1-A4, P, I, D, OH, OL, MR, DR

External Loop Control Parameter Settings DV External loop control parameter settings

Syntax	DV p1 , p2 , p3 <terminator> p1: Loop number (1–16, or 1–4 on the CX1000) p2: Parameter names MODE/AT/RL/SR/MOUT/SPN p3: Parameter value MODE: Switch between manual/automatic/cascade 0: Automatic operation 1: Manual operation (cascade control's primary loop cannot be selected) 2: Cascade operation (only cascade control's secondary loop can be selected) AT: Execution and stop of auto tuning 0: Stop auto tuning 1: Execute PID number 1 : 8: Execute PID number 8 9: ALL For UT320/UT321/UT350/UT351, 5–8 is not needed.
--------	--

RL:	Select remote/local 0: Local operation 1: Remote operation (cannot be selected in the following cases. UT420/UT450/UT520/UT550: control mode is single loop and no control hold function UT750: control mode is cascade secondary Not available with UT320/UT321/UT350/UT351
SR:	Operation start/stop 0: Operation start 1: Operation start Not available depending on the UT operation mode
MOUT:	Changing the control output value (available during manual operation) During On/off control: 0.0%, 100.0% When other than onoff control: -5.0% to 105.0%
SPN:	Switching the target setpoint number 1: Select target setpoint number 1 : 8: Select target setpoint number 8 For UT320/UT321/UT350/UT351, can select 1–4

Example Run external loop 2 automatically.
DV2, MODE, 0

6.5 Setting Commands (Measurement)

SR Sets the input range

When setting channels to skip

Syntax SR p1, p2<terminator>
p1: Channel number (01 to 20) (01 to 06 on the CX1000)
p2: Range mode (SKIP)
Query SR[p1]?
Example Set channel 01 to skip.
SR01, SKIP

Description • This command cannot be specified while measurement/computation is in progress or while a report is being created.
• Measurements are not made on channels that are set to SKIP.

When setting the channels to voltage, TC, RTD, or ON/OFF input

Syntax SR p1, p2, p3, p4, p5<terminator>
p1: Channel number (01 to 20) (01 to 06 on the CX1000)
p2: Input type
VOLT DC voltage
TC TC
RTD RTD
DI ON/OFF input
p3: Measurement range
p4: Span lower limit
p5: Span upper limit
Query SR[p1]?
Example Set the input type for channel 01 to TC type R, span lower limit to 0°C, and span upper limit to 1760.0°C.
SR01, TC, R, 0, 17600

Description • This command cannot be specified while measurement/computation is in progress or while a report is being created.
• Set parameters p3, p4, and p5 according to the table in section 6.3.
• For parameters p4 and p5, enter a value using 5 digits or less excluding the decimal point. The decimal position is fixed to the position indicated in the table in section 6.3.

When computing the difference between channels

Syntax SR p1, p2, p3, p4, p5, p6, p7<terminator>
p1: Channel number (01 to 20) (01 to 06 on the CX1000)
p2: Range mode (DELTA)
p3: Input type
VOLT DC voltage
TC TC
RTD RTD
DI ON/OFF input

6.5 Setting Commands (Measurement)

- p4: Measurement range
- p5: Span lower limit
- p6: Span upper limit
- p7: Reference channel: 01 to 20 (01 to 06 on the CX1000)

Query SR[p1]?

Example Set the range mode of channel 10 to the difference computation between channels with the reference channel set to 01 and set the input type to TC. Set the range to R. Set the span lower limit to 10.0°C and span upper limit to 100.0°C.

SR10, DELTA, TC, R, 100, 1000, 01

- Description
- This command cannot be specified while measurement/computation is in progress or while a report is being created.
 - Set parameters p4, p5, and p6 according to the table in section 6.3.
 - For parameters p5 and p6, enter a value using 5 digits or less excluding the decimal point. The decimal position is fixed to the position indicated in the table in section 6.3.

When setting channels to scaling

Syntax SR p1, p2, p3, p4, p5, p6, p7, p8, p9, p10 <terminator>

p1: Channel number (01 to 20) (01 to 06 on the CX1000)

p2: Range mode (SCALE)

p3: Input type

VOLT	DC voltage
TC	TC
RTD	RTD
DI ON/OFF	input

p4: Measurement range

p5: Span lower limit

p6: Span upper limit

p7: Scale lower limit (–30000 to 30000)

p8: Scale upper limit (–30000 to 30000)

p9: Scale decimal point position (0 to 4)

p10: Unit (up to 6 characters)

Query SR[p1]?

Example Convert the DC voltage measured on channel 02 to a DC current. Set the measurement range to 6 V, span lower limit to 1 V, span upper limit to 5 V, scale lower limit to 1.00 A, and scale upper limit to 5.00 A.

SR02, SCALE, VOLT, 6V, 1000, 5000, 100, 500, 2, A

- Description
- This command cannot be specified while measurement/computation is in progress or while a report is being created.
 - Set parameters p4, p5, and p6 according to the table in section 6.3.

- For parameters p5 and p6, enter a value using 5 digits or less excluding the decimal point. The decimal position is fixed to the position indicated in the table in section 6.3.
- For parameters p7, p8, and p9, either set all three parameters or omit all three parameters.

When setting channels to square root computation

Syntax SR p1, p2, p3, p4, p5, p6, p7, p8, p9 <terminator>

p1: Channel number (01 to 20) (01 to 06 on the CX1000)

p2: Range mode (SQRT)

p3: Measurement range

p4: Span lower limit

p5: Span upper limit

p6: Scale lower limit (–30000 to 30000)

p7: Scale upper limit (–30000 to 30000)

p8 Scale decimal point position (0 to 4)

p9 Unit (up to 6 characters)

Query SR[p1]?

Example Convert the DC voltage measured on channel 01 to the amount of flow using the square root computation. Set the measurement range to 6 V, span lower limit to 1 V, span upper limit to 5 V, scale lower limit to 10.0 m³/s, and scale upper limit to 100.0 m³/s.

SR01, SQRT, 6V, 1000, 5000, 100, 1000, 1, m³/s

- Description
- This command cannot be specified while measurement/computation is in progress or while a report is being created.
 - Set parameters p3, p4, and p5 according to the table in section 6.3.
 - For parameters p4 and p5, enter a value using 5 digits or less excluding the decimal point. The decimal position is fixed to the position indicated in the table in section 6.3.
 - For parameters p6, p7, and p8, either set all three parameters or omit all three parameters.

SO Sets the computing equation

Syntax SO p1, p2, p3, p4, p5, p6, p7 <terminator>

p1 Computation channel number (31 to 60) (31 to 42 on the CX1000)

p2 Turn ON/OFF computation (On, Off)

p3 Computing equation (up to 40 characters)

p4 Span lower limit (–9999999 to 99999999)

p5 Span upper limit (–9999999 to 99999999)

p6 Span decimal point position (0 to 4)

p7 Unit (up to 6 characters)

Query SO[p1]?

Example Set the computation channel to 31, the computation to ON, the computing equation to the sum of channel 01 and 02, span lower limit to -10.0000, span upper limit to 16.0000, and the unit to V.

```
SO31,ON,01+02,-100000,160000,4,V
```

- Description**
- This command can be used on models with the computation function option /M1.
 - This command cannot be specified while measurement/computation is in progress or while a report is being created.
 - For a description of the computing equations, see the *user's manual IM 04L31A01-01E or IM 04L31A01-03E*.
 - For parameters p4 and p5, enter a value using 7 digits or less ,excluding the decimal, for negative numbers and 8 digits or less for positive numbers.
 - For parameters p4, p5, and p6, either set all three parameters or omit all three parameters.

SA Setting the alarm

When not using the alarm

Syntax SA p1 , p2 , p3 <terminator>
 p1 Channel number (01 to 20, 31 to 60) (01 to 06, 31 to 42 on the CX1000)
 p2 Alarm number (1 to 4)
 p3 Turn ON/OFF alarm (OFF)

Query SA[p1 [, p2]] ?

Example Turn Off alarm number 1 of channel 10.
 SA10,1,OFF

Description Computation channels (31 to 60) can only be specified on models with the computation function option /M1.

When using the alarm

Syntax SA p1 , p2 , p3 , p4 , p5 , p6 , p7 , p8 <terminator>
 p1: Channel number (01 to 20, 31 to 60) (01 to 06, 31 to 42 on the CX1000)
 p2: Alarm number (1 to 4)
 p3: Turn ON/OFF alarm (ON)
 p4: Alarm type
 H High limit alarm
 L Low limit alarm
 h Difference high limit alarm
 l Difference low limit alarm
 R High limit on rate-of-change alarm
 r Low limit on rate-of-change alarm
 T Delay high limit alarm
 t Delay low limit alarm
 Characters are case-sensitive.)
 p5: Alarm value
 p6: Relay setting
 ON Relay setting ON
 OFF Relay setting OFF

When p6 is ON

p7: Relay number (I01 to I06, I11 to I16, I21 to I26, I31 to I36, DO001 to DO006, DO101 to DO106, DO201 to DO206, RO001 to RO012, SW001 to SW036)
 p8: Display and recording ON/OFF

When p6 is OFF

p7: Display and recording ON/OFF

Query SA[p1 [, p2]] ?

Example Set an upper limit alarm (alarm value = 1000) in alarm number 1 of channel 02, and activate relay number 1 when an alarm occurs.
 SA02,1,ON,H,1000,ON,I01

- Description**
- When the input range setting (SR command) is set to SKIP, p3 cannot be turned ON.
 - When the computation channel setting (SO command) is turned OFF, p3 cannot be turned ON.
 - The alarm settings are all turned OFF for the following cases.
 - When the input type is changed (VOLT, TC, etc).
 - When the measurement range is changed.
 - When the span and scale values are changed during scale display (including changing of the decimal position.)
 - When the computation channel is turned ON/OFF or when the computing equation or the span value is changed on the computation channel.
 - The h and l settings of p4 are valid only when the measurement range is set to computation between channels.
 - If p4 is set to R or r, set the interval for the high/low limit on the rate-of-change using the XA command.
 - If p4 is set to T or t, set the alarm delay time for the delay high/low limit alarm using the BD command.
 - For the range of alarm values of p5, see the table in section 6.3.
 - Set the alarm value of a computation channel within the range of the span.
 - For the alarm value of p5, enter a value using 5 digits or less, excluding the decimal. For computation channels, enter a value using 8 digits or less, excluding the decimal.
 - An error occurs if a number of a relay that is not installed is specified in p7. For the procedures of setting the relay numbers, see the *user's manual IM 04L31A01-01E or IM 04L31A01-03E*.
 - Computation channels (31 to 60) can only be specified on models with the computation function option /M1.

6.5 Setting Commands (Measurement)

- For computation channels, the alarm types that can be specified are only H (high limit alarm), L (low limit alarm), T (delay high limit alarm), and t (delay low limit alarm).
- For computation channels, the alarm hysteresis is fixed to zero. Use the XA command to set the alarm hysteresis.

SD Sets the date and time

Syntax SD p1, p2<terminator>
p1: Date (YY/MM/DD fixed form)
YY Year (00 to 99)
MM Month (01 to 12)
DD Day (01 to 31)
p2: Time (HH/MM/SS fixed form)
HH Hour (00 to 23)
MM Minute (00 to 59)
SS Second (00 to 59)

Query SD?

Example Set the internal clock to 13:00:00, October 1, 1999.
SD99/10/01, 13:00:00

Description The form of p1 and p2 is fixed to 8 characters. Use the following form. Do not enter spaces between the digits; otherwise an error will occur.
p1 = YY/MM/DD (Lower two digits of the year/month/day)
p2 = HH:MM:SS (Hour:minute:second)

SW Sets the display update rate/ auto-save interval

Syntax SW p1, p2<terminator>
p1: Display update rate (15S, 30S, 1MIN, 2MIN, 5MIN, 10MIN, 20MIN, 30MIN, 1H, 2H, 4H, 10H)
p2: Auto-save interval (10MIN, 20MIN, 30MIN, 1H, 2H, 3H, 4H, 6H, 8H, 12H, 1DAY, 2DAY, 3DAY, 5DAY, 7DAY, 10DAY, 14DAY, 31DAY)

Query SW?

Example Set the display update rate to one minute and the auto-save interval to 10 minutes.
SW1MIN, 10MIN

Description

- This command cannot be specified while measurement is in progress.
- The selectable auto-save interval (p2) varies depending on the display update rate (p1) setting. For details, see the *user's manual IM 04L31A01-01E or IM 04L31A01-03E*.
- The p2 setting is valid when the saving method to the external storage medium is set to auto using the XM command (p1 of the XM command is set to AUTO).

SZ Sets the zone

Syntax SZ p1, p2, p3<terminator>
p1: Channel number (01 to 20, 31 to 60, 101 to 118, 201 to 248) (01 to 06, 31 to 42, 101 to 106, 201 to 212 on the CX1000)
p2: Zone lower position (0 to 95) [%]
p3: Zone upper position (5 to 100) [%]

Query SZ[p1]?

Example Display channel 02 in a zone between 30% and 50%.
SZ02, 30, 50

Description

- Computation channels (31 to 60) can only be specified on models with the computation function option /M1.
- The total display width of the screen in the direction of the amplitude is taken to be 100%.
- The zone width must be at least 5%.
- Set the parameters for the zone upper and lower limits so that the upper limit is greater than the lower limit.

SP Sets the partial expanded display

Syntax SP p1, p2, p3, p4<terminator>
p1: Channel number (01 to 20, 31 to 60, 101 to 118, 201 to 248) (01 to 06, 31 to 42, 101 to 106, 201 to 212 on the CX1000)
p2: Enable/disable (ON/OFF) the partial expansion setting.
p3: Boundary position (1 to 99) [%]
p4: Boundary value

Query SP[p1]?

Example Partially expand the display of channel 01. Set the boundary position to 25% and the boundary value to 1.00 V.
SP01, ON, 25, 100

Description

- Computation channels (31 to 60) can only be specified on models with the computation function option /M1.
- When the input range setting (SR command) is set to SKIP, p2 cannot be turned ON.
- When the computation channel setting (SO command) is turned OFF, p2 cannot be turned ON.
- The range of the span upper and lower limits (scale upper and low limits when scale is enabled) is taken to be 100% for parameter p3.
- Parameter p4 can be set in the range (span upper limit – 1) to (span lower limit + 1). If scale is enabled, the range is (scale upper limit – 1) to (scale lower limit + 1).
- The decimal position and the number of digits become the same as the span and scale settings (see the SR command).
- This command (including a query) can be specified when the partial expanded display function of the XU command is set to USE.

- This command cannot be specified if the partial expanded display range does not exist (when the span width is set to 1, for example).

ST Sets the tag

Syntax ST p1 , p2 <terminator>
 p1: Channel number (01 to 20, 31 to 60, 101 to 118, 201 to 248) (01 to 06, 31 to 42, 101 to 106, 201 to 212 on the CX1000)
 p2: Tag (up to 16 characters)

Query ST[p1]?

Example Set the tag of channel 02 to TAG2.
 ST02 , TAG2

Description • For the characters that can be used for the tags, see appendix 1, "ASCII Character Codes." Note that semicolons and commas cannot be used.

- Computation channels (31 to 60) can only be specified on models with the computation function option /M1.

SX Sets the group

Syntax SX p1 , p2 , p3 <terminator>
 p1: Group number (1 to 10) (1 to 6 on the CX1000)
 p2: Group name (up to 16 characters)
 p3: Channel configuration

Query SX[p1]?

Example Set channels 01, 03, 04 to 06 to group number 1 using a group name GROUP2.
 SX1 , GROUP2 , 01 . 03 . 04 - 06
 Set the channel configuration by using periods to separate each channel or by using a hyphen to specify a range of channels. If no channels are assigned, specify a space.

Description For the characters that can be used for the group names, see appendix 1, "ASCII Character Codes." Note that semicolons and commas cannot be used.

SL Sets the trip line

Syntax SL p1 , p2 , p3 , p4 , p5 <terminator>
 p1: Group number (1 to 10) (1 to 6 on the CX1000)
 p2: Number of trip line (1 to 4)
 p3: Turn ON/OFF the trip line display
 p4: Display position (0 to 100) [%]
 p5: Display color (RED, GREEN, BLUE, B.VIOLET, BROWN, ORANGE, Y.GREEN, LIGHTBLUE, VIOLET, GRAY, LIME, CYAN, DARKBLUE, YELLOW, LIGHTGRAY, PURPLE)

Query SL[p1 [, p2]]?

Example Display trip line 1 in red for group 1.
 SL1 , 1 , ON , 10 , RED

Description The total display width of the screen in the direction of the amplitude is taken to be 100%.

SG Sets the message

Syntax SG p1 , p2 <terminator>
 p1: Message number (1 to 8)
 p2: Message (up to 16 characters)

Query SG[p1]?

Example Set character string "MESSAGE1" in message number 1.
 SG1 , MESSAGE1

Description For the characters that can be used for the messages, see appendix 1, "ASCII Character Codes." Note that semicolons and commas cannot be used.

SH Sets the file header

Syntax SH p1 , p2 , p3 <terminator>
 p1: Header for the files saved to the external storage medium (Up to 32 characters)
 p2: Directory (up to 8 characters)
 p3: Data to be saved to the external storage medium (UNSAVE, ALL)

Query SH?

Example Add a header, DATA1 and save the file to the DATAFILE directory. Save only the data in the internal memory that has not been saved.
 SHDATA1 , DATAFILE , UNSAVE

Description • "Data to be saved to the external storage medium" includes the display, event, TLOG, manual sampled, and report data.

- Parameter p3 is valid when the saving method to the external storage medium is set to manual using the XM command (parameter p1 of the XM command is set to MANUAL).

SE Sets the display direction, background color, trend line width, trip line width, number of grids, scroll time, and scale display digits

Syntax SE p1 , p2 , p3 , p4 , p5 , p6 , p7 , p8 , p9 <terminator>
 p1: Display direction of the trend waveform (HORIZONTAL, VERTICAL, HORIZON2)
 p2: Display direction of the bar graph waveform (HORIZONTAL, VERTICAL)
 p3: Measurement background color (WHITE, BLACK)
 p4: Control background color (WHITE, BLACK)
 p5: The line width of the trend (1 to 3) [dot]
 p6: The width of the trip line (1 to 3) [dot]
 p7: Number of grids (4 to 12, AUTO)
 p8: The time interval (scroll time) for switching displayed groups (5s, 10s, 20s, 30s, 1min)
 p9: Scale display digits (NORMAL, FINE)

Query SE?

6.5 Setting Commands (Measurement)

Example Set the display direction of the trend waveform to horizontal, the direction of the bar graph to vertical, the measurement background color to white, the control background color to white, the line width of the trend to 1 dot, the width of the trip line to 2 dots, the number of grids to 10, the time interval for switching displayed group to 20s, and the scale display digits to normal.
SEHORIZONTAL, VERTICAL, WHITE, WHITE, 1, 2, 10, 20s, NORMAL

SB Sets the number of scale divisions, base position of the bar graph, and the display position of the trend scale

Syntax SB p1, p2, p3, p4<terminator>
p1: Channel number (01 to 20, 31 to 60, 101 to 118, 201 to 248) (01 to 06, 31 to 42, 101 to 106, 201 to 212 on the CX1000)
p2: Number of scale divisions (4 to 12, C10)
p3: Base position of the bar graph display (NORMAL, CENTER)
p4: Position of the scale for the trend display (OFF, 1 to 10 (1 to 6 on the CX1000))

Query SB[p1]?

Example Set the number of scale divisions of the bar graph of channel 02 to 5, and display the bar graph from the span lower limit (scale lower limit if scale is enabled). Display the scale at the third position.
SB02, 5, NORMAL, 3

Description

- Computation channels (31 to 60) can only be specified on models with the computation function option /M1.
- The base position (p3) is valid when the display direction of the bar graph is set to HORIZONTAL. Use the SE command to set the display direction of the bar graph.

SV Sets the rolling average of the measured channel

Syntax SV p1, p2<terminator>
p1: Channel number (01 to 20) (01 to 06 on the CX1000)
p2: Number of samples for computing the rolling average (OFF, 2 to 16) [times]

Query SV[p1]?

Example Set the number of samples for computing the rolling average of channel 02 to 12.
SV02, 12

SC Sets the channel display color

Syntax SC p1, p2<terminator>
p1: Channel number (01 to 20, 31 to 60, 101 to 118, 201 to 248) (01 to 06, 31 to 42, 101 to 106, 201 to 212 on the CX1000)
p2: Display color (RED, GREEN, BLUE, B.VIOLET, BROWN, ORANGE, Y.GREEN, LIGHTBLUE, VIOLET, GRAY, LIME, CYAN, DARKBLUE, YELLOW, LIGHTGRAY, PURPLE)

Query SC[p1]?

Example Set the display color of channel 02 to blue.
SC02, BLUE

Description Computation channels (31 to 60) can only be specified on models with the computation function option /M1.

SQ Sets the LCD brightness and the screen backlight saver

When turning OFF the screen backlight saver function

Syntax SQ p1, p2<terminator>
p1: LCD brightness (1 to 4) (1 to 8 on the CX1000)
p2: Screen backlight saver function ON/OFF (OFF)

Query SQ?

Example Set the LCD brightness to 2 and the screen backlight saver function to OFF.
SQ2, OFF

When turning ON the screen backlight saver function

Syntax SQ p1, p2, p3, p4<terminator>
p1: LCD brightness (1 to 4) (1 to 8 on the CX1000)
p2: Screen backlight saver function ON/OFF (ON)
p3: Time after which to enable the screen saver function (1MIN, 2MIN, 5MIN, 10MIN, 30MIN, 1H)
p4: Factors that cause the screen to return from the saver mode (KEY, KEY+ALM)

Query SQ?

Example Set the LCD brightness to 2, the screen backlight saver function to ON, the time after which to enable the screen backlight saver function to 1MIN, and the factor that causes the screen to return from the saver mode to KEY.
SQ2, ON, 1MIN, KEY

SY Sets the 4 screen display (CX2000 only)

Syntax `SY p1,p2,p3,p4,p5,p6,p7,p8,p9,p10 <terminator>`

p1: 4 screen display number (1 to 4)

p2: Four screen display name (up to 16 characters)

p3: The display item of the upper left quadrant of the divided screen

TREND	Trend display
DIGITAL	Digital display
BAR	Bar graph display
OVERVIEW	Overview display (Alarm indicator)
ALARM	Alarm summary display
MESSAGE	Message summary display
MEMORY	Memory summary display
FACEPLATE	Control faceplate
CONTROLLER	Control digital display
HYBRID	Control bar graph display
CTRLOVER	Control overview
CTRLDO	DO status display
CTRLSUMMARY	Control operation summary
CTRLSW	Internal switch status display
EVENTSUMMARY	Program event summary

p4: Group number to be displayed at quadrant 1
The selectable range of group numbers varies depending on the display type as follows:

TREND/DIGITAL/BAR: 1 to 10
OVERVIEW/ALARM/MESSAGE/MEMORY: Group specification is invalid.
FACEPLATE/CONTROLLER/HYBRID: 1 to 8
CTRLOVER/CTRLDO/CTRLSUMMARY/ EVENTSUMMARY: Group specification is invalid.

p5: Display item on the lower left screen (screen 2) of the 4 screens (same selections as p3)

p6: Number of the group to be displayed on the lower left screen (screen 2)

p7: Display item on the upper right screen (screen 3) (same selections as p3)

p8: Number of the group to be displayed on the upper right screen (screen 3)

p9: Display item on the lower right screen (screen 4) (same selections as p3)

p10: Number of the group to be displayed on the lower right screen (screen 4)

Query `SY[p1]?`

Example Set the four screen display number to 1, four screen display name to 4DISPLAY1, the display item of screen 1 to trend display, the group number to display in screen 1 to 1, the display item of screen 2 to digital display, the group number to display in screen 2 to 2, the display item of screen 3 to bar graph display, the group number to display in screen 3 to 3, the display item of screen 4 to message summary display, and the group number to display in screen 4 to 4.
`SY1,4DISPLAY1,TREND,1,DIGITAL,2, BAR,3,MESSAGE,4`

Description The p4, p6, p8, and p10 parameters are valid when p3, p5, p7, and p9 are set to a display other than OVERVIEW, respectively.

SU Sets the USER key

Syntax `SU p1<terminator>`

p1: Key action

NONE	No action
ALARM ACK	Alarm acknowledge
MANUAL SAMPLE	Manual sample
TRIGGER	External trigger input (Event data)
MESSAGE1	Write message 1
MESSAGE2	Write message 2
MESSAGE3	Write message 3
MESSAGE4	Write message 4
MESSAGE5	Write message 5
MESSAGE6	Write message 6
MESSAGE7	Write message 7
MESSAGE8	Write message 8
SNAPSHOT	Snapshot
MATH START/STOP	Start/Stop MATH
MATH RESET	Reset MATH

Query `SU?`

Example Set the key action to the snapshot.
`SUSNAPSHOT`

SK Sets the computation constant

Syntax `SK p1,p2<terminator>`

p1: Computation constant number (K01 to K30) (K01 to K12 on the CX1000)

p2: Constant (up to 11 characters)
The selectable range is $-9.9999E+29$ to $-1.0000E-30$, 0, and $1.0000E-30$ to $9.9999E+29$
(The + sign of "E+" can be omitted.)

Query `SK[p1]?`

Example Set constant $1.0000E-10$ for computation constant number K01.
`SKK01,1.0000E-10`

Description • This command can be used on models with the computation function option /M1.

6.5 Setting Commands (Measurement)

- This command cannot be specified while measurement/computation is in progress or while a report is being created.

SI Sets the rolling average of the computation channel

When turning OFF the rolling average of the computation channel

Syntax SI p1 , p2 <terminator>
p1: Computation channel number (31 to 60) (31 to 42 on the CX1000)
p2: Rolling average ON/OFF (OFF)

Query SI[p1]?

Example Turn OFF the rolling average of computation channel number 31.
SI31,OFF

Description This command can be used on models with the computation function option /M1.

When turning ON the rolling average of the computation channel

Syntax SI p1 , p2 , p3 , p4 <terminator>
p1: Computation channel number (31 to 60) (31 to 42 on the CX1000)
p2: Rolling average ON/OFF (ON)
p3: Sampling interval (1S, 2S, 3S, 4S, 5S, 6S, 10S, 12S, 15S, 20S, 30S, 1MIN, 2MIN, 3MIN, 4MIN, 5MIN, 6MIN, 10MIN, 12MIN, 15MIN, 20MIN, 30MIN, 1H)
p4: Number of samples (1 to 64)

Query SI[p1]?

Example Turn the rolling average of computation channel 31 ON, set the sampling interval to 1 minute, and the number of samples to 20.
SI31,ON,1MIN,20

Description This command can be used on models with the computation function option /M1.

SJ Sets the TLOG timer

Syntax SJ p1 , p2 , p3 <terminator>
p1: Computation channel number (31 to 60) (31 to 42 on the CX1000)
p2: Timer (1 to 3)
p3: Conversion of the time unit for TLOG.SUM computation
OFF No conversion
/S Convert as though the physical values are integrated in units of seconds.
/MIN Convert as though the physical values are integrated in units of minutes.
/H Convert as though the physical values are integrated in units of hours.

Query SJ[p1]?

Example Set timer 1 to computation channel number 31. No conversion of time unit.
SJ31,1,OFF

Description • This command can be used on models with the computation function option /M1.
• This command cannot be specified while computation is in progress.
• About p3
Because the sampled data are integrated over each scan interval, the physical value integrated over a given period may be different from the actual integrated value. This occurs if the given period is not equal to the scan interval. In these cases, set p3 to the unit of the integration time desired. The integrated value is found according to the following conversion equations that depend on the parameter.
OFF $\Sigma(\text{Measured value})$
/S $\Sigma(\text{Measured value}) \times \text{scan interval}$
/MIN $\Sigma(\text{Measured value}) \times \text{scan interval}/60$
/HOUR $\Sigma(\text{Measured value}) \times \text{scan interval}/3600$
The unit of the scan interval is seconds.

SS Sets the date and time at which to switch the daylight savings time

When the switching the daylight savings time is OFF

Syntax SS p1 , p2 <terminator>
p1 Summer time or winter time (SUMMER, WINTER)
p2 Enable/disable (ON/OFF) the switching (OFF)

Query SS[p1]?

Example Set the summer time is OFF.
SSSUMMER,OFF

Description This command can be used on models with the display language code "-2."

When the switching the daylight savings time is ON

Syntax SS p1 , p2 , p3 <terminator>
p1 Summer time or winter time (SUMMER, WINTER)
p2 Enable/disable (ON/OFF) the switching (ON)
p3 Date and time (yy/mm/dd hh fixed form. Insert a space between dd and hh.)
yy Year (00 to 99)
mm Month (01 to 12)
dd Day (01 to 31)
hh Hour (00 to 23)

Query SS[p1]?

Example Set the summer time to the 23rd hour of June 30, 2000.

```
SSSUMMER, ON, 00/06/30 23
```

(The 23rd hour of June 30, 2000 is set to 0 hour of July 1, 2000.)

Description This command can be used on models with the display language code "-2."

FR Sets the interval for acquiring data to the FIFO buffer

Syntax FR p1<terminator>

p1: FIFO acquisition interval (1S, 2S)

Query FR?

Example Set the FIFO acquisition interval to 1 s.

```
FR1S
```

Description

- Set the acquisition interval to a value greater than the scan interval.
- If the scan interval is set to a value less than the acquisition interval using the XV command or from the screen, the acquisition interval is automatically set equal to the scan interval.
- The CX has a circular FIFO (First In First Out) buffer. The measured/computed values are acquired to the internal memory at predetermined time intervals from the time the power is turned ON, and the data are output when a FF command is received. The previous output position is held for each connection and is updated when the next set of data is output with the FF command. This scheme compensates for the differences in the processing power of the measurement PC and the communication delay. This enables data to be retrieved without any dropouts if the measurement PC reads the data before the ring buffer is overwritten. For details on the output flow of the FIFO data, see appendix 4.

BA Sets the application name, the supervisor name, and the manager name

Syntax BA p1, p2, p3<terminator>

p1 Application name (Up to 16 characters)

p2 Supervisor name (Up to 16 characters)

p3 Manager name (Up to 16 characters)

Query BA?

Example Set the application name to "A", the supervisor name to "B", and the manager name to "c."

```
BAA, B, C
```

Description This command can be used on models with the batch header option /BT1.

BB Sets the batch number, the lot number, automatic increment of the lot number, and the displayed information

Syntax BB p1, p2, p3, p4<terminator>

p1 Batch number (Up to 16 characters)

p2 Lot number (0 to 9999)

p3 Enable/disable automatic increment of the lot number (ON, OFF)

p4 Displayed information (BATCH, TIME)

Query BB?

Example Set the batch number to "LOT", the lot number to "2", enable automatic increment of the lot number, and set the displayed information to "BATCH."

```
BBLOT, 2, ON, BATCH
```

Description This command can be used on models with the batch header option /BT1.

BC Sets the comment number and the character string

Syntax BC p1, p2<terminator>

p1 Comment number (1 to 3)

p2 Character string (Up to 32 characters)

Query BC?

Example Set the character string "COMMENT" to the comment number 1.

```
BC1, COMMENT
```

Description This command can be used on models with the batch header option /BT1.

BD Sets the alarm delay time

Syntax BD p1, p2<terminator>

p1: Channel number (01 to 20, 31 to 60) (01 to 06, 31 to 42 on the CX1000)

p2: Alarm delay (1 to 3600) [s]

Query BD[p1]?

Example Set the alarm delay of channel 01 to 120 s.

```
BD01, 120
```

6.6 Setting Commands (Operation)

UD Switches the screen

When switching the screen back to the screen that existed before settings were changed using communication commands

Syntax UD p1<terminator>
p1: Screen switching (0)

Example Switch the screen back to the screen that existed before settings were changed using communication commands.
UD0

When changing to 1 screen display

Syntax UD p1, p2, p3<terminator>
p1: Screen switching (1)
p2: Display item

TREND	Trend display
DIGITAL	Digital display
BAR	Bar graph display
OVERVIEW	Overview display (Alarm indicator)
ALARM	Alarm summary display
MESSAGE	Message summary display
MEMORY	Memory summary display
FACEPLATE	Control faceplate
CONTROLLER	Control digital display
HYBRID	Control bar graph display
CTRLOVER	Control overview display
PROGRAM	Program control display (valid only during 1 screen display (set using UD1))
CTRLDO	DO status display
CTRLSUMMARY	Control operation summary
CTRLSW	Internal switch status display
EVENTSUMMARY	Program event summary

p3: Group number to be displayed
The selectable range of group numbers varies depending on the display type as follows:
TREND/DIGITAL/BAR: 1 to 10
OVERVIEW/ALARM/MESSAGE/MEMORY: Group specification is invalid.
FACEPLATE/CONTROLLER/HYBRID: 1 to 8
CTRLOVER/PROGRAM/PROGRAMHIST/CTRLDO/CTRLSUMMARY/
EVENTSUMMARY: Group specification is invalid.

Example Set the display to 1 screen trend and set the number of the group to be displayed to 4.
UD1, TREND, 4

When changing to 4 screen display (CX2000 only)

Syntax UD p1, p2, p3, p4, p5, p6, p7, p8, p9
<terminator>
p1: Screen switching (2)
p2: The display item of the upper left quadrant of the divided screen

TREND	Trend display
DIGITAL	Digital display
BAR	Bar graph display
OVERVIEW	Overview display (Alarm indicator)
ALARM	Alarm summary display
MESSAGE	Message summary display
MEMORY	Memory summary display
FACEPLATE	Control faceplate
CONTROLLER	Control digital display
HYBRID	Control bar graph display
CTRLOVER	Control overview display
PROGRAM	Program control display (valid only during 1 screen display (set using UD1))
CTRLDO	DO status display
CTRLSUMMARY	Control operation summary
EVENTSUMMARY	Program event summary

p3: Group number to be displayed at screen 1
The selectable range of group numbers varies depending on the display type as follows:
TREND/DIGITAL/BAR: 1 to 10
OVERVIEW/ALARM/MESSAGE/MEMORY: Group specification is invalid.
FACEPLATE/CONTROLLER/HYBRID: 1 to 8
CTRLOVER/PROGRAM/PROGRAMHIST/CTRLDO/CTRLSUMMARY/
EVENTSUMMARY: Group specification is invalid.

p4: Display item on the lower left screen (screen 2) (same selections as p2)
p5: Number of the group to be displayed on the lower left screen (screen 2)
p6: Display item on the upper right screen (screen 3) (same selections as p2)
p7: Number of the group to be displayed on the upper right screen (screen 3)

p8: Display item on the lower right screen (screen 4) (same selections as p2)
 p9: Number of the group to be displayed on the lower right screen (screen 4)

Example Set the screen to four screen display, the display item of screen 1 to trend display, the group number to display in screen 1 to 1, the display item of screen 2 to digital display, the group number to display in screen 2 to 2, the display item of screen 3 to bar graph display, the group number to display in screen 3 to 3, the display item of screen 4 to message summary display, and the group number to display in screen 4 to 4.

```
UD2, TREND, 1, DIGITAL, 2, BAR, 3,
MESSAGE, 4
```

Description The p3, p5, p7, and p9 parameters are valid when p2, p4, p6, and p8 are set to a display other than OVERVIEW, respectively.

When displaying the 4 screen display set with the SY command (CX2000 only)

Syntax UD p1, p2<terminator>
 p1: Screen switching (3)
 p2: 4 screen display number (0 to 4)

- 0 The screen is set to the 4 screen display that result by setting parameter p1 to 2 using the UD command. This setting (p1 = 3, p2 = 0) is valid only when the 4 screen display is enabled by setting p1 to 2 beforehand.
- 1 Display the screen of 4 screen display number 1 that was specified with the SY command.
- 2 Display the screen of 4 screen display number 2 that was specified with the SY command.
- 3 Display the screen of 4 screen display number 3 that was specified with the SY command.
- 4 Display the screen of 4 screen display number 4 that was specified with the SY command.

Example Display the screen of 4 screen display number 1 that was specified with the SY command.

```
UD3, 1
```

When turning ON/OFF the automatic display switching, switching between all channel display and group display, enabling/disabling the scale display, and enabling/disabling digital display (numerical display section)

Syntax UD p1, p2, p3, p4, p5<terminator>
 p1: Screen switching (4)
 p2: Enables/disables automatic display switching (ON/, OFF)

p3: Switches between all channel display and group display (All, Group)
 p4: Turns ON/OFF the scale display
 p5: Turns ON/OFF the digital display

Example Enable the automatic display switching, switch to the group display, turn ON the scale display, and turn OFF the digital display.

```
UD4, ON, GROUP, ON, OFF
```

Description

- Parameter p2 is valid for the trend, digital, or bar graph displays. Use the SE command to set the scroll interval.
- Parameters p3 and p4 are valid for the trend display.
- Parameter p5 is valid for the trend or 4 screen trend displays.

PS Starts/Stops measurements

Syntax PS p1<terminator>
 p1: Starts/Stops measurements
 0 Start
 1 Stop

Example Start the measurement.

```
PS0
```

Description When measurement is started, the display, event, and report data is acquired to the internal memory.

AK Confirms the alarm status (alarm acknowledge)

Syntax AK p1<terminator>
 p1: Executes alarm acknowledge (0)

Example Confirm the current held condition of the alarm (execute alarm acknowledge).

```
AK0
```

EV Saves the manual sample, manual trigger, snapshot, display data, saves the event data

Syntax EV p1<terminator>
 p1: Operation type

- 0 Execute manual sampling.
- 1 Activate manual trigger.
- 2 Take a snapshot.
- 3 Save display data to the external storage medium.
- 4 Save event data to the external storage medium.

Example Execute manual sampling.

```
EV0
```

6.6 Setting Commands (Operation)

- Description
- EV3 is valid when display data are being acquired to the internal memory, and the CX is set to store the data to the external storage medium using auto save. The display data residing in the internal memory can be stored to the external storage medium at arbitrary times.
 - EV4 is valid when event data are being acquired to the internal memory in the free run mode, and the CX is set to store the data to the external storage medium using auto save. The event data residing in the internal memory can be stored to the external storage medium at arbitrary times.

MS Writes the message (display and save)

- Syntax `MS p1<terminator>`
p1: Message number (1 to 8)
- Example Write the message of message number 8.
`MS8`
- Description This command displays the message to the screen and writes the message in the display data and event data.

TL Starts/stops/resets computation (MATH)/clears the computation dropout status display

- Syntax `TL p1<terminator>`
p1: Operation type
- 0 Start computation
 - 1 Stop computation
 - 2 Reset computation
 - 3 Clear the computation dropout status display
- Example Starting the computation.
`TL0`
- Description
- This command cannot be executed while setup data are being saved or loaded.
 - This command can be used on models with the computation function option /M1.

DS Switches execution modes (operation/basic setting)

- Syntax `DS p1<terminator>`
p1: Mode type
- 0 Operation mode
 - 1 Basic setting mode
- Example Set the mode to basic setting mode.
`DS1`
- Description
- Parameter p1 cannot be set to 1 while measurement/computation is in progress, while the external storage medium is being formatted, or while data are being saved to the external storage medium.
 - Parameter p1 cannot be set to 0 while the external storage medium is being formatted or while data are being saved to the external storage medium.
 - To activate the settings that are changed using the basic setting commands, the settings must be saved using the XE command. Make sure to save the settings with the XE command before changing from the basic setting mode to the operation mode. Otherwise, new settings will not be activated.

LO Loads the setup data for setting commands

- Syntax `LO p1<terminator>`
p1: File name (up to 8 characters)
- Example Load the setting data of setting commands from the setup file SETFILE1 (.pcl extension).
`LOSETFILE1`
- Description
- This command cannot be used to load the setup data of the basic setting commands. To load the setup data of both setting and basic setting commands, use the YO command.
 - This command cannot be specified on models that do not have an external storage device or when a medium is not inserted into the drive.
 - This command cannot be used while the setup data file is being output (specified using the FE command).
 - This command cannot be used while program control is in execution.

LI Saves the setup data

- Syntax** LI p1<terminator>
p1: File name (up to 8 characters)
- Example** Save the setup data of both setting and basic setting commands to the file SETFILE2.
LISETFILE2
- Description**
- A “.pcl” extension is attached to the saved file.
 - This command cannot be specified on models that do not have an external storage device or when a medium is not inserted into the drive.
 - This command cannot be used while the setup data file is being output (specified using the FE command).
 - This command cannot be used when the #1 Program parameter setting display under #7 Program-control parameters in Set mode is shown(or after sending the PB command).

CM Sets the communication input data

- Syntax** CM p1, p2<terminator>
p1: Communication input data number (C01 to C30)
p2: Communication input data
The selectable range is -9.9999E+29 to -1.0000E-30, 0, and 1.0000E-30 to 9.9999E+29
(The + sign of “E+” can be omitted.)
- Query** CM?
- Example** Set 1.0000E-10 to communication input data number C01.
CMC01, 1.0000E-10
- Description** This command can be used on models with the computation function option /M1.

EM Starts/stops e-mail transmission function

- Syntax** EM p1<terminator>
p1: Operation type
0 Start
1 Stop
- Example** Start the e-mail transmission function.
EM0
- Description** To use the e-mail transmission function, you must set the Ethernet interface, e-mail address, and contents to be transmitted. For details on setting these items, see section 2.11.

DL Mode switching for the DIO operation monitoring function

- Syntax** DL p1, p2<terminator>
p1: DIO operation monitoring number (01-36, 1-12 for the CX1000)
p2: Auto/manual switching
0 Automatic
1 Manual
- Example** When the output mode for DIO operation monitoring number 4 is Automatic.
DL4, 0

DM Sets the manual output value for DIO operation monitoring function

- Syntax** DM p1, p2<terminator>
p1: DIO operation monitoring number (01-36, 1-12 for the CX1000)
p2: Manual output value
0 Off
1 On
- Example** Set DIO operation monitoring number 4 to Manual.
DM4, 1

DP DO/internal switch status settings

- Syntax** DP p1, p2<terminator>
p1: Relay numbers
DO001-DO006
DO101-DO106
DO201-DO206
RO001-RO012 (expansion module)
SW001-SW036 (internal switch)
DO001-DO006 and SW001-SW018 for the CX1000.
p2: Status of relay (switch)
0 Off
1 On
- Example** Turn internal switches SW008 ON.
DPSW008, 1

6.7 Basic Setting Commands (Measurement)

- To activate the settings that are changed using the basic setting commands, the settings must be saved using the XE command. Make sure to save the settings with the XE command before changing from the basic setting mode to the operation mode. Otherwise, new settings will not be activated.
- The settings that are returned in response to a query in the basic setting mode will contain the new settings even if they are not saved with the XE command. However, the new settings will not be activated until they are saved. In order to activate the new settings, the XE command must be issued as described earlier. If the settings are not saved or cleared using the XE command and the execution mode is changed from the basic setting mode to the operation mode, the settings that are returned in the response to a query will contain the settings that existed before they were changed.

Note

The settings that are changed using the YA/YK/YN/YQ/YS/YG/YL/YM command are activated after saving the new settings using the XE command and rebooting the CX.

XA Sets alarm related settings

Syntax XA p1 , p2 , p3 , p4 , p5 , p6 , p7 , p8<terminator>
 p1: Turn ON/OFF reflash (ON, OFF)
 p2: Relay number set to AND logic (NONE, I01, I01-Ixx)
 Ixx: I02 to I06, I11 to I16, I21 to I26, I31 to I36
 p3: Energize/De-energize the relay (ENERGIZE, DE_ENERGIZE)
 p4: Hold/Not hold the relay (HOLD, NONHOLD)
 p5: Hold/Not hold the alarm status indication (HOLD, NONHOLD)
 p6: Interval for the upper limit on the rate-of-change (1 to 15)
 p7: Interval for the lower limit on the rate-of-change (1 to 15)
 p8: Turn ON/OFF the alarm hysteresis (ON, OFF)

Query XA?

Example Set relay numbers I01 to I12 to AND logic. Enable reflash. Set the alarm to energizing and hold. Set the alarm status indication to hold. Set the interval for the upper limit on the rate-of-change to 10 and the interval for the lower limit on the rate-of-change to 12. Enable alarm hysteresis.
 XAON, I01-I12, ENERGIZE, HOLD, HOLD, 10, 12, ON

- Description**
- The interval is set in units of the scan interval. The XV command is used to set the scan interval.
 - The hysteresis setting does not apply to computation channels.

XI Sets the A/D integral time

Syntax XI p1<terminator>
 p1: A/D integral time (AUTO, 50HZ, 60HZ, 100MS)

Query XI?

Example Set the A/D integral time to 50 Hz.
 XI50HZ

XB Sets the burn out

Syntax XB p1 , p2<terminator>
 p1: Channel number (01 to 20) (01 to 06 on the CX1000)
 p2: Burn out procedure (OFF, UP, DOWN)

Query XB[p1]?

Example Set to UP (+ overflow) when channel 01 burns out.
 XB01, UP

XJ Sets the RJC

When using the internal compensation circuit

Syntax XJ p1 , p2<terminator>
 p1: Channel number (01 to 20) (01 to 06 on the CX1000)
 p2: Reference junction compensation selection (INTERNAL)

Query XJ[p1]?

Example Set the RJC of channel 01 to the internal compensation circuit.
 XJ01, INTERNAL

When using an external RJC

Syntax XJ p1 , p2 , p3<terminator>
 p1: Channel number (01 to 20) (01 to 06 on the CX1000)
 p2: Reference junction compensation selection (EXTERNAL)
 p3: External RJC value (-20000 to 20000)

Query XJ[p1]?

Example Set the reference junction compensation of channel 02 to external and set the compensation value to 0 mV.
 XJ02, EXTERNAL, 0

Description The unit of p3 is mV.

XV Sets the scan interval

Syntax `XV p1<terminator>`
 p1: Scan interval
 1S, 2S

Query `XV?`

Example Set the scan interval to 1 s.
`XV1S`

XT Selects the temperature unit

Syntax `XT p1<terminator>`
 p1 Temperature unit
 C Celsius (°C)
 F Fahrenheit (°F)

Query `XT?`

Example Set the temperature unit to Fahrenheit.
`XTF`

Description This command can be used on models with the display language code “-2”.

XS Sets the channels used to display the trend and acquire the data

Syntax `XS p1, p2<terminator>`
 p1: Channel number (01 to 20, 31 to 60, 101 to 118, 201 to 248) (01 to 06, 31 to 42, 101 to 106, 201 to 212 on the CX1000)
 p2: Enable/disable (ON, OFF) displaying of the trend and acquiring of the data

Query `XS [p1]?`

Example Enable displaying of the trend and acquiring of the data on channel 01.
`XS01, ON`

Description Computation channels (31 to 60) can only be specified on models with the computation function option /M1.

XM Sets the conditions used to acquire display/event data to the internal memory or save the data to the external storage medium

Syntax `XM p1, p2, p3, p4, p5, p6, p7, p8, p9, p10 <terminator>`
 p1: Method of saving data to the external storage medium (AUTO, MANUAL)
 p2: Data type (DISPLAY, EVENT, E+D)
 p3: Sample rate of event data (125MS, 250MS, 500MS, 1S, 2S, 10S, 30S, 60S, 120S, 300S, 600S)
 p4: Event mode (FREE, TRIGGER, ROTATE)
 p5: Number of blocks
 When p2 is set to EVENT 1, 2, 4, 8, 16
 When p2 is set to E+D 1, 2, 4

p6: Event data length (3MIN, 5MIN, 10MIN, 20MIN, 30MIN, 1H, 2H, 3H, 4H, 6H, 8H, 12H, 1DAY, 2DAY, 3DAY, 5DAY, 7DAY, 10DAY, 14DAY, 31DAY)

p7: Pretrigger(0, 5, 25, 50, 75, 95, 100) [%]

p8: Turn ON/OFF manual trigger (ON, OFF)

p9: Turn ON/OFF external trigger (ON, OFF)

p10: Turn ON/OFF alarm trigger (ON, OFF)

Query `XM?`

Example Set the method of saving data to the external storage medium to auto, the data type to both display data and event data, the sample rate to 10 s, the event mode to TRIGGER, the event data length to 30 minutes, the number of blocks to 1, the pretrigger to 50%, the manual trigger to ON, the external trigger to ON, and the alarm trigger to ON.

`XMAUTO, E+D, 10S, TRIGGER, 1, 30MIN, 50, ON, ON, ON`

- Description
- The setting of p6 is valid when p1 is AUTO and p4 is FREE.
 - The setting of Parameters p3 through p10 are valid when p2 is set to EVENT or E+D.
 - When p2 is set to E+D, p4 cannot be set to FREE.
 - The settings of p5 to p10 are valid when p4 is TRIGGER or ROTATE.
 - The event data length selection (p5) varies depending on the p3 setting and the number of channels that are measuring and computing. For details, see the *user's manual IM 04L31A01-01E or IM 04L31A01-03E*.

XU Sets the channel identification display, memory alarm time, language, whether or not to use the partial expanded display function and the batch function

Syntax `XU p1, p2, p3, p4<terminator>`
 p1: The display used to identify the measurement/computation channels (TAG, CHANNEL)
 p2: Memory alarm time (1H, 2H, 5H, 10H, 20H, 50H, 100H)
 p3: Language (ENGLISH, JAPANESE)
 p4: Use/Not use partial expanded display function (USE, NOT)

Query `XU?`

Example Set the display used to identify the measurement/computation channels to channel numbers, the memory alarm length to 1 hour, the language to English, use the partial expansion function and the batch function.

`XUCHANNEL, 1H, JAPANESE, USE, USE`

Description The SP command can be used when parameter p4 of this command is set to USE.

6.7 Basic Setting Commands (Measurement)

XR Sets the remote action

Syntax	XR p1 , p2<terminator>
	p1: Remote number (1 to 8)
	p2: Remote action
	NONE No action
	ALARM ACK Alarm acknowledge
	MEMORY START/STOP Start/stop measurement
	MANUAL SAMPLE Manual sample
	TRIGGER External trigger input (event data)
	MESSAGE1 Write message 1
	MESSAGE2 Write message 2
	MESSAGE3 Write message 3
	MESSAGE4 Write message 4
	MESSAGE5 Write message 5
	MESSAGE6 Write message 6
	MESSAGE7 Write message 7
	MESSAGE8 Write message 8
	PANEL1 LOAD Load setting 1
	PANEL2 LOAD Load setting 2
	PANEL3 LOAD Load setting 3
	MATH START/STOP Start/Stop MATH
	MATH RESET Reset MATH
	TIME ADJUST Adjust time
	SNAPSHOT Snapshot

Query XR[p1]?

Example Set the remote action of remote number 1 to writing message 1.
XR1 , MESSAGE1

XQ Sets the timer

When not using the timer

Syntax XQ p1 , p2<terminator>
p1: Timer number (1 to 3)
p2: Timer type (OFF)

Query XQ[p1]?

Example Turn the number 1 timer OFF.
XQ1 , OFF

Description This command can be used on models with the computation function option /M1.

When using the absolute timer

Syntax XQ p1 , p2 , p3 , p4 , p5 , p6<terminator>
p1: Timer number (1 to 3)
p2: Timer type (ABSOLUTE)
p3: Interval (1MIN, 2MIN, 3MIN, 4MIN, 5MIN, 6MIN, 10MIN, 12MIN, 15MIN, 20MIN, 30MIN, 1H, 2H, 3H, 4H, 6H, 8H, 12H, 24H)
p4: Reference Time (hh fixed form)
hh Hour (00 to 23)
p5: Reset/not reset the sum value when the timer expires. (ON/OFF)
p6: Action to be taken when the timer expires (OFF, DATA SAVE)

Query XQ[p1]?

Example Set an absolute timer to timer number 1. Set the sampling interval to 30 minutes, the reference time to 7 O'clock, reset the integrated value when the timer expires, and set no action when the timer expires.

XQ1 , ABSOLUTE , 30MIN , 07 , ON , OFF

Description • This command can be used on models with the computation function option /M1.
• The timer expires at the interval specified by parameter 3 from the time specified by p4, and performs the operation set with parameters p5 and p6.

When using the relative timer

Syntax XQ p1 , p2 , p3 , p4 , p5<terminator>

p1: Timer number (1 to 3)

p2: Timer type (RELATIVE)

p3: Interval (hh:mm fixed format)

hh Hour (00 to 24)

mm Minute (00 to 59)

Set the interval in the range 00:01 to 24:00

p4: Reset/not reset the sum value when the timer expires. (ON/OFF)

p5: Action to be taken when the timer expires (OFF, DATA SAVE)

Query XQ[p1]?

Example Set a relative timer to timer number 1. Set the sampling interval to 1 hour 15 minutes, reset the integrated value when the timer expires, and set no action when the timer expires.

XQ1 , RELATIVE , 01 : 15 , ON , OFF

Description • This command can be used on models with the computation function option /M1.
• The timer expires at the interval specified by parameter p3 from the time the CX is turned ON, from the time the timer is reset, and from the time when the timer is turned OFF. When the timer expires, the operation set with parameters p4 and p5 are carried out.

RO Sets the report type and generation time

When report type is set to none

Syntax RO p1<terminator>

p1: Report type (OFF)

Query RO?

Example Set report to none.
ROOFF

Description This command can be used on models with the computation function option /M1.

For hourly, daily, hourly + daily and daily + monthly reports

Syntax RO p1 , p2 , p3 <terminator>
 p1: Report type (HOURLY, DAY, HOURLY+DAY, DAY+MONTH)
 p2: Date of creation (dd fixed form)
 ddDay (01 to 28)
 p3: Hour of creation (hh fixed form)
 hhHour (00 to 23)

Query RO?

Example Create a daily report at 9 o'clock everyday (parameter p2 ("05" in this example) is invalid in this case).
 RODAY , 05 , 09

Description This command can be used on models with the computation function option /M1.

For daily+weekly reports

Syntax RO p1 , p2 , p3 <terminator>
 p1: Report type (DAY+WEEK)
 p2: Day of creation (SUN, MON, TUE, WED, THU, FRI, SAT)
 p3: Hour of creation (hh fixed form)
 hhHour (00 to 23)

Query RO?

Example Create a daily report at 9 o'clock everyday, and a weekly report every Tuesday.
 RODAY+WEEK , TUE , 09

Description This command can be used on models with the computation function option /M1.

RM Sets the report channel**When not using the report channel**

Syntax RM p1 , p2 <terminator>
 p1: Report channel number (01 to 30) (01 to 12 on the CX1000)
 p2: Use/Not use the report channel (OFF)

Query RM[p1]?

Example Set the report channel of number 1 to not used.
 RM01 , OFF

Description This command can be used on models with the computation function option /M1.

When using the report channel

Syntax RM p1 , p2 , p3 , p4 <terminator>
 p1: Report channel number (01 to 30) (01 to 12 on the CX1000)
 p2: Use/Not use the report channel (ON)
 p3: The measurement/computation channel number on which reports are to be made (01 to 20, 31 to 60) (01 to 06, 31 to 42 on the CX1000)

p4: Summation conversion of the waveform on which integration is to be performed

OFF No conversion

/S Convert as though the physical values are integrated in units of seconds.

/MIN Convert as though the physical values are integrated in units of minutes.

/H Convert as though the physical values are integrated in units of hours.

/DAY Convert as though the physical values are integrated in units of days.

Query RM[p1]?

Example Use the report channel number 1. Set the measurement/computation channel number on which reports are to be made to 01, and the summation conversion of the waveform on which integration is to be performed to 1 s.
 RM01 , ON , 01 , /S

Description

- This command can be used on models with the computation function option /M1.
- About p4
 Because the sampled data are integrated over each scan interval, the physical value integrated over a given period may be different from the actual integrated value. This occurs if the given period is not equal to the scan interval. In these cases, set p4 to the unit of the integration time desired. The integrated value is found according to the following conversion equations that depend on the parameter.

OFF $\Sigma(\text{Measured value})$

/S $\Sigma(\text{Measured value}) \times \text{scan interval}$

/MIN $\Sigma(\text{Measured value}) \times \text{scan interval} / 60$

/HOUR $\Sigma(\text{Measured value}) \times \text{scan interval} / 3600$

/DAY $\Sigma(\text{Measured value}) \times \text{scan interval} / 86400$

The unit of the scan interval is seconds.

6.7 Basic Setting Commands (Measurement)

XO Selects the communication interface used to output data residing in the internal memory (display, event, TLOG, manual sampled, and report data) and files on the external storage medium using output commands (ME/MI/MO commands)

Syntax XO p1<terminator>
p1: Communication type
ETHERNET Ethernet
SERIAL Serial

Query XO?

Example Set the communication interface to Ethernet (the communication interface is used to output data in the internal memory and files on the external storage medium using the ME/MI/MO commands).

Description SERIAL can be selected on models with the serial interface option.
XOETHERNET

XH Sets whether or not to use the key login, auto logout, and user ID functions

Syntax XH p1, p2, p3<terminator>
p1: Use/not use the key login function (USE, NOT)
p2: Use/not use the auto logout function (ON, OFF)
p3: Use/not use the User ID function (USE, NOT)

Query XH?

Example Use the key login, auto logout, and user ID functions.
XHUSE, ON, USE

XE Sets whether or not to store the basic settings

Syntax XE p1<terminator>
p1: Store or discard the settings (STORE, ABORT)

Example Store the basic settings.
XESTORE

Description To activate the settings that are changed using the basic setting commands, the settings must be saved using the XE command. Make sure to save the settings with the XE command before changing from the basic setting mode to the operation mode. Otherwise, new settings will not be activated.

XG Sets the time zone

Syntax XG p1<terminator>
p1: Offset time from GMT (–1200 to 1200)
Upper 2 digits: Hour (00 to 12)
Lower 2 digits: Minute (00 to 59)

Example Set the offset time from the GMT to 9 hours ahead.
XG0900

XP Sets the memory timeup date and time

When not using the timeup function

Syntax XP p1<terminator>
p1: Timeup type (OFF)

Query XP?

Example Turn timeup OFF.
XPOFF

When the timeup type is “hour” “day” or “month”

Syntax XP p1, p2, p3<terminator>
p1: Timeup type (HOUR, DAY, MONTH)
p2: Date when the timer is to expire (dd fixed form)
dd Day (01 to 28)
p3: Hour when the timer is to expire (hh fixed form)
hh Hour (00 to 23)

Query XP?

Example Set the timer to expire at 9 O'clock every day (parameter p2 (“05” in this example) is invalid in this case).
XPDAY, 05, 09

When the timeup type is “week”

Syntax XP p1, p2, p3<terminator>
p1: Timeup type (WEEK)
p2: Day of the week when the timer is to expire (SUN, MON, TUE, WED, THU, FRI, SAT)
p3: Hour when the timer is to expire (hh fixed form)
hh Hour (00 to 23)

Query XP?

Example Set the timer to expire at 9 O'clock every Tuesday.
XPWEEK, TUE, 09

YA Sets the IP address, subnet mask, and default gateway

Syntax `YA p1 , p2 , p3 <terminator>`
 p1: IP address (0.0.0.0 to 255.255.255.255)
 p2: Subnet mask
 (0.0.0.0 to 255.255.255.255)
 p3: Default gateway
 (0.0.0.0 to 255.255.255.255)

Query `YA?`

Example Set the IP address to 192.168.111.24, subnet mask to 255.255.255.0, and default gateway to 0.0.0.0.
`YA192.168.111.24,255.255.255.0,0.0.0.0`

Description The settings specified by this command take effect after the CX is power cycled.

YK Sets keep alive

Syntax `YK p1 <terminator>`
 p1: Enable/Disable keep alive (ON, OFF)

Query `YK?`

Example Disable keep alive.

`YKOFF`

Description The settings specified by this command take effect after the CX is power cycled.

YN Sets the DNS**When not using the DNS**

Syntax `YN p1 <terminator>`
 p1: Use/Not use the DNS (OFF)

Query `YN?`

Example Do not use the DNS.

`YNOFF`

Description The settings specified by this command take effect after the CX is power cycled.

When using the DNS

Syntax `YN p1 , p2 , p3 , p4 , p5 , p6 , p7 <terminator>`
 p1: Use/Not use the DNS (ON)
 p2: Address of the primary DNS server
 (0.0.0.0 to 255.255.255.255)
 p3: Address of the secondary DNS server
 (0.0.0.0 to 255.255.255.255)
 p4: Host name (up to 64 characters)
 p5: Domain name (up to 64 characters)
 p6: Domain suffix 1 (up to 64 characters)
 p7: Domain suffix 2 (up to 64 characters)

Query `YN?`

Example Use the DNS server at 192.168.0.1.
`YNON,192.168.0.1`

Description The settings specified by this command take effect after the CX is power cycled.

YQ Sets the communication timeout**When not using the timeout**

Syntax `YQ p1 <terminator>`
 p1: Enable/Disable communication timeout
 (OFF)

Query `YQ?`

Example Disable timeout.

`YQOFF`

Description The settings specified by this command take effect after the CX is power cycled.

When using the timeout

Syntax `YQ p1 , p2 <terminator>`
 p1: Enable/Disable communication timeout
 (ON)
 p2: Timeout time (1 to 120) [minutes]

Query `YQ?`

Example Enable communication timeout and set the timeout period to 3 min.

`YQON,3`

Description The settings specified by this command take effect after the CX is power cycled.

YS Sets the serial interface

Syntax `YS p1 , p2 , p3 , p4 , p5 , p6 <terminator>`
 p1: Baud rate (1200, 2400, 4800, 9600, 19200, 38400)
 p2: Data length (7, 8)
 p3: Parity check (NONE, ODD, EVEN)
 p4: Handshaking (OFF:OFF, XON:XON, XON:RS, CS:RS)
 p5: RS-422A/485 address (01 to 32)
 p6: Protocol (NORMAL, MODBUS, MODBUS-M, LADDER)

Query `YS?`

Example Set the baud rate to 9600, the data length to 8, the parity check to ODD, handshaking to OFF:OFF, the RS-422A/485 address to 02, and the protocol to NORMAL.

`YS9600,8,ODD,OFF:OFF,02,NORMAL`

Description • The settings specified by this command take effect after the CX is power cycled.
 • SERIAL can be selected on models with the serial interface option.

6.7 Basic Setting Commands (Measurement)

YO Loads setup data

- Syntax** YO p1<terminator>
p1: File name (up to 8 characters)
- Example** Load the setup data of both setting and basic setting commands from the setup file SETFILE1 (.pcl extension).
YOSETFILE1
- Description**
- This command loads the setting data of both setting and basic setting commands. To load only the setting data of setting commands, use the LO command.
 - When this command is executed, the communication is disconnected.
 - This command cannot be specified on models that do not have an external storage device or when a medium is not inserted into the drive.
 - This command cannot be used while the setup data file is being output (specified using the FE command).
 - This command cannot be used while program control is in execution.

YC Clears the measured/computed data, initializes setup data

- Syntax** YC p1<terminator>
p1: Type of data to be cleared or initialized
- | | |
|---|--|
| 0 | Clear all measured/computed data and initialize the setup data of the setting mode and basic setting mode. |
| 1 | Clear all measured/computed data and initialize the setup data of the setting mode. |
| 2 | Clear all measured/computed data. |
- Example** Clear all measured/computed data.
YC2
- Description**
- The measured/computed data indicates the data residing in the internal memory of the CX.
 - This command cannot be specified while the external storage medium is being formatted.

YT Sets the FTP transfer timing

- Syntax** YT p1, p2<terminator>
p1: Auto transfer when display and event data files are created (ON, OFF)
p2: Auto transfer when report data files are created (ON, OFF)
- Query** YT?
- Example** Auto transfer the display and event data files. Do not transfer the report data file.
YTON, OFF
- Description** When the method to save the data to the external storage medium is set to "Auto," the data files are automatically transferred when they are created. For details on how data is stored, see the *user's manual IM 04L31A01-01E or IM 04L31A01-03E*.

YG Sets whether to use the Web server function

- Syntax** YG p1<terminator>
p1: Use/not use the Web server function (Use, Not)
- Query** YG?
- Example** Use the Web server function.
YGUSE
- Description**
- For details on the settings of the Ethernet, the types of Web pages that can be displayed, and access control, see sections 2.3 and 2.9.
 - The settings specified by this command take effect after the CX is power cycled.

YL Sets the operation of the Modbus master function

- Syntax** YL p1, p2, p3<terminator>
p1: Read cycle (125MS, 250MS, 500MS, 1S, 2S, 5S, 10S, 15S, 20S, 30S)
p2: Timeout (125MS, 250MS, 500MS, 1S, 2S, 5S, 10S, 1MIN)
p3: Retrials (OFF, 1 to 5, 10, 20)
- Query** YL?
- Example** Set the read cycle to 500MS, timeout to 250MS, and retrieals to 2.
YL500MS, 250MS, 2
- Description**
- This command is valid when the serial interface protocol is set to "Master." For a description of setting the serial interface, see section 4.2.
 - The settings specified by this command take effect after the CX is power cycled.

YM Sets the command of the Modbus master function

When not setting a command

- Syntax** YM p1, p2<terminator>
p1: Registration number (1 to 8)
p2: Turn On/Off the command (OFF)
- Query** YM[p1]?
- Example** Do not set a command to command registration number 1.
YM1, OFF

When setting a command

- Syntax** YM p1, p2, p3, p4, p5, p6, p7<terminator>
p1: Registration number (1 to 8)
p2: Turn On/Off the command (ON)
p3: Start channel number (C01 to C30) (C01 to C12 on the CX1000)
p4: Last channel number (C01 to C30) (C01 to C12 on the CX1000)
p5: Slave device address (1 to 247)

	p6: First register number (30001 to 39999, 40001 to 49999, 300001 to 365535, 400001 to 465535)
	p7: Type of data assigned to the register (INT16, UINT16, INT32_B, INT32_L, UINT32_B, UINT32_L, FLOAT_B, FLOAT_L)
Query	YM[p1]?
Example	Register the following command in command registration number 2: Read the 32-bit signed integer data that is assigned to registers 30003 (upper 16 bits) and 30004 (lower 16 bits) of the slave device at address 5 into C02 of the CX. YM2,ON,C02,C02,5,30003,INT32_B
Description	<ul style="list-style-type: none"> This command is valid when the serial interface protocol is set to "Master." For a description of setting the serial interface, see section 4.2. The settings specified by this command take effect after the CX is power cycled.

YU Sets the contents to be sent via e-mail

When sending the changes in the alarm status

Syntax	YU p1,p2,p3,p4,p5,p6,p7,p8,p9,p10,p11,p12<terminator>
	p1: Transmitted content (ALARM)
	p2: Enable/disable recipient 1 (ON, OFF)
	p3: Enable/disable recipient 2 (ON, OFF)
	p4: Enable/disable alarm transmission of alarm number 1 (ON, OFF)
	p5: Enable/disable alarm transmission of alarm number 2 (ON, OFF)
	p6: Enable/disable alarm transmission of alarm number 3 (ON, OFF)
	p7: Enable/disable alarm transmission of alarm number 4 (ON, OFF)
	p8: Enable/disable attachment of instantaneous data (ON, OFF)
	p9: Enable/disable attachment of source URL (ON, OFF)
	p10: Subject (up to 32 characters)
	p11: Header 1 (up to 64 characters)
	p12: Header 2 (up to 64 characters)
Query	YU[p1]?
Example	Transmit alarms of alarm numbers 1 to 4 including instantaneous data but not including the source URL to recipient 1. The subject is "ALM", and the header is "LP2". YUALARM,ON,OFF,ON,ON,ON,ON,ON,OFF,ALM,LP2

When sending e-mail at scheduled times

Syntax	YU p1,p2,p3,p4,p5,p6,p7,p8,p9,p10,p11,p12<terminator>
	p1: Transmitted content (TIME)
	p2: Enable/disable recipient 1 (ON, OFF)
	p3: Interval for sending e-mail to recipient 1 (1H, 2H, 3H, 4H, 6H, 8H, 12H, 24H)
	p4: Time when sending e-mail to recipient 1 (HH:MM)
	p5: Enable/disable recipient 2 (ON, OFF)
	p6: Interval for sending e-mail to recipient 2 (1H, 2H, 3H, 4H, 6H, 8H, 12H, 24H)
	p7: Time when sending e-mail to recipient 2 (HH:MM)
	p8: Enable/disable attachment of instantaneous data (ON, OFF)
	p9: Enable/disable attachment of source URL (ON, OFF)
	p10: Subject (up to 32 characters)
	p11: Header 1 (up to 64 characters)
	p12: Header 2 (up to 64 characters)
Query	YU[p1]?
Example	Send e-mail at 17 hours 15 minutes every day to recipient 1. Do not include instantaneous data but include the source URL. The subject is "GOOD", and the header is "LP2". YUTIME,ON,24H,17:15,OFF,,,OFF,ON,GOOD,LP2

When sending system notifications

Syntax	YU p1,p2,p3,p4,p5,p6,p7<terminator>
	p1: Transmitted content (SYSTEM)
	p2: Enable/disable recipient 1 (ON, OFF)
	p3: Enable/disable recipient 2 (ON, OFF)
	p4: Enable/disable attachment of source URL (ON, OFF)
	p5: Subject (up to 32 characters)
	p6: Header 1 (up to 64 characters)
	p7: Header 2 (up to 64 characters)
Query	YU[p1]?
Example	Send system notification e-mail messages including the source URL to recipient 1. The subject is "SystemAlert", and the header is "LP2". YUSYSTEM,ON,OFF,ON,SystemAlert,LP2

When sending report generation notifications

Syntax	YU p1,p2,p3,p4,p5,p6,p7<terminator>
	p1: Transmitted content (REPORT)
	p2: Enable/disable recipient 1 (ON, OFF)
	p3: Enable/disable recipient 2 (ON, OFF)
	p4: Enable/disable attachment of source URL (ON, OFF)
	p5: Subject (up to 32 characters)
	p6: Header 1 (up to 64 characters)
	p7: Header 2 (up to 64 characters)
Query	YU[p1]?

6.7 Basic Setting Commands (Measurement)

Example Send report generation notification e-mail messages including the source URL to recipient 1. The subject is "Report", and the header is "LP2".

```
YUREPORT,ON,OFF,ON,Report,LP2
```

- Description**
- For the contents of the system notification, see section 2.11.
 - Report generation notification can be used on models with the computation function option / M1.
 - For details on the settings of e-mail, see sections 2.3 and 2.11.

YV Sets the e-mail recipient address

Syntax YV p1,p2<terminator>

p1: Select Recipient

1: Recipient 1

2: Recipient 2

p2: Recipient address (up to 150 characters)

Query YV[p1]?

Example Set recipient 1 to "Cont@good.com" and "Adm@good.com".

```
YV1,Cont@good.com Adm@good.com
```

- Description**
- To set multiple recipients, separate each recipient with a space.
 - For details on the settings of e-mail, see sections 2.3 and 2.11.

YW Sets the e-mail sender address

Syntax YW p1<terminator>

p1: Sender address (up to 64 characters)

Query YW?

Example Set the sender address to "CX2000".

```
YWCX2000
```

- Description** For details on the settings of e-mail, see sections 2.3 and 2.11.

YX Sets the e-mail SMTP server name

Syntax YX p1,p2<terminator>

p1: SMTP server name (up to 64 characters)

p2: Port number (0 to 65535).

Query YX?

Example Set the SMTP server to "mhs.good.com" and port number to "25".

```
YXmhs.good.com,25
```

- Description** For details on the settings of e-mail, see sections 2.3 and 2.11.

ML Sets the communication buffer recovery processing

Syntax ML p1<terminator>

p1: DO/internal switches processing

Continue: hold the status

Clear: clear the status

Query ML?

Example During communication buffer recovery, clears DO and the internal switches.

```
MLclear
```

MM Sets the modbus mouse/temperature meter communication automatic recovery

Syntax MM p1,p2<terminator>

p1: Turns automatic recovery On/Off

p2: Intervals: 1min, 2min, 5min, 10min, 20min, 30min, or 60min.

Query MM?

Example Temperature meter communications automatically restored after 5 minutes.

```
MMON,5min
```

6.8 Basic Setting Commands (Control)

Control Action, Input Setting

GB Sets the PID group number

Syntax GB p1<terminator>
 p1: PID group number (1 to 8)

Query GB?

Example Set the PID group number to 6.
 GB6

GI Sets the control period

Syntax GI p1<terminator>
 p1: Control period (250ms, 500ms, 1s)
 Fixed to 1s for A/D integral time of 100 ms.

Query GI?

Example Set the control period to 500ms.
 GI500MS

HX Sets control action parameters

Syntax HX p1 , p2 , p3 , p4<terminator>
 p1: Zone PID selection (Off, On)
 p2: Restart mode
 (Continue, Manual, Auto)
 p3: Restart mode (program)
 (Continue, Manual, Reset)
 p4: Initial PID (Temp, Press+Flow)

Query HX?

Example Set the zone PID to On, restart mode to auto, restart mode (program) to manual, and set the initial PID for temperature.
 HXON , AUTO , MANUAL , TEMP

PY Sets 6/4loop select (CX2000 only)

Syntax PY p1<terminator>
 p1: Loop type (6Loop, 4Loop)

Query PY?

Example Switch the number of loops to 6.
 PY6LOOP

HQ Turns Off/On auto tuning

Syntax HQ p1<terminator>
 p1: Auto tuning Off/On (Off, On)

Query HQ?

Example Turn On auto tuning.
 HQON

PC Sets the control mode

Syntax PC p1 , p2 , p3<terminator>
 p1: Loop number (1 to 6) (1 or 2 on the CX1000)
 p2: Control mode*
 *: Off
 Single
 Cascade
 PVSwitching
 Retrans

p3: Switching method
 (Range, PVHigh, Signal)

Query PC[p1]?

Example Set the control mode of loop 1 to loop control with PV switching and set the switching method to temperature range.
 PC1 , PVSWITCHING , RANGE
 Set the control mode of loop 3 to cascade.
 PC3 , CASCADE

PP Turns Off/On the program control

Syntax PP p1 , p2<terminator>
 p1: Loop number (1 to 6) (1 or 2 on the CX1000)
 p2: Turns Off/On the program control (Off, On)

Query PP[p1]?

Example Turn On program control of loop 3.
 PP3 , ON

GM Sets the PID control mode

Syntax GM p1 , p2<terminator>
 p1: Loop number (1 to 6) (1 or 2 on the CX1000)
 p2: PID control mode (Follow-up, Fixed-point)

Query GM[p1]?

Example Set the PID control mode of loop 4 to fixed-point control.
 GM4 , FIXED-POINT

HB Sets the burn out

Syntax HB p1 , p2 , p3<terminator>
 p1: Loop number (1 to 6) (1 or 2 on the CX1000)
 p2: Input number (1 to 3)
 1: Measure 1
 2: Measure 2
 3: Remote

p3: Burn out (Off, Up, Down)

Query HB[p1 , p2]?

Example Set the burnout of loop 6 measure 1 to Up.
 HB6 , 1 , UP

Description Valid when PV/SP computation is OFF.

6.8 Basic Setting Commands (Control)

MK Burnout settings

Syntax MK p1 , p2<terminator>
p1: Control input channel numbers (CI01–CI10,
or CI01–CI05 for the CX1000)
p2: Burnout settings (on/off)

Query MK[p1]?

Description Valid when PV/SP computation is ON.

HR Sets the RJC

Syntax HR p1 , p2 , p3 , p4<terminator>
p1: Loop number (1 to 6) (1 or 2 on the CX1000)
p2: Input number (1 to 3)
1: Measure 1
2: Measure 2
3: Remote
p3: RJC method (External, Internal)
p4: RJC value (–20000 to 20000)

Query HR[p1 , p2]?

Example Set the RJC of Loop 2 remote to external and
1000 μ V.
HR2 , 3 , EXTERNAL , 1000

Description Valid when PV/SP computation is OFF.

MJ Sets the RJC

Syntax MJ p1 , p2 , p3 , p4<terminator>
p1: Control input channel numbers (CI01–CI10,
or CI01–CI05 for the CX1000)
p2: RJC method (External, Internal)
p3: RJC value (–20000 to 20000)

Query MJ[p1]?

Description Valid when PV/SP computation is ON.

GT Contact Input Registration/AUX Registers contact inputs

Syntax GT p1 , p2 , p3<terminator>
p1: Module type*1
p2: Contact number*2
p3: Function type*3

*1: CTRL1-DI, CTRL1-DO,
CTRL2-DI, CTRL2-DO,
CTRL3-DI, CTRL3-DO,
EXT1-RI, EXT1-RO, INT-SW1, INT-
SW2, INT-SW3
For the CX1000, CTRL1-DI, CTRL1-DO,
INT-SW1, INT-SW2, INT-SW3.
However,
INT-SW1:SW001-SW012
(or SW001-SW006 for the CX1000)
INT-SW2:SW013-SW024
(or SW007-SW012 for the CX1000)
INT-SW3:SW025-SW036
(or SW013-SW018 for the CX1000)

*2: DI001 to DI006
DI101 to DI106
DI201 to DI206
RI001 to RI012 (expansion module)
SW001 to SW036 (Internal switch)
On the CX1000: DI001 to DI006,
SW001 to SW036

*3: None
Auto1-2/3-4 (only during cascade
control)
Auto1-2 only on the CX1000
Man1-2/3-4(only during cascade control)
Man1-2 only on the CX1000
Cascade1-2/3-4 (only during cascade
control)
Cascade1-2 only on the CX1000
Auto/Man (1, 2/3, 4/5, 6 (1, 2 on the
CX1000) for each module)
ControlStart/Stop1 to 6 (1 or 2 on the
CX1000)
(1, 2/3, 4/5, 6 (1, 2 on the CX1000)
for each module)
Remote/Local1 to 6 (1 or 2 on the
CX1000)
(1, 2/3, 4/5, 6 (1, 2 on the CX1000)
for each module)
AllControlStart
AllControlStop
SPNumber0bit to 3bit (Fixed to 6 to 3 on
the control module). (Fixed to 12 to 9 on
the expansion module). (The contacts
are automatically assigned according to
the specified number of bits)
ProgramReset
ProgramRun
Hold
Advance
PatternNo0bit to 4bit (Fixed to 1 to 5
on the control module).
(Fixed to 1 to 5 on the expansion
module).
(The contacts are automatically
assigned according to the specified
number of bits)
PVSwitching1 to 4 (1 or 2 on the
CX1000) (valid only during loop
control with PV switching)
You can also specify the remote action
of the XR command. For details on the
remote action, see XR command.

Query GT[p1 , p2]?

Example Set the contact number 1 whose module type is
CTRL1-2 to "AllControlStart".
GTCTRL1-2 , DI001 , ALLCONTROLSTART

GS Sets remote input

Syntax GS p1,p2<terminator>
 p1: Loop number (1 to 6) (1 or 2 on the CX1000)
 p2: Remote input
 (Off, Remote)

Query GS [p1]?

Example Use the remote of loop 2.
 GS2,REMOTE

HG Sets the alarm mode

Syntax HG p1,p2<terminator>
 p1: Loop number (1 to 6) (1 or 2 on the CX1000)
 p2: Alarm mode
 (Always,Stop,Stop/Man)

Query HG [p1]?

Example Set the alarm mode of loop 2 to stop.
 HG2,STOP

HY Sets the SP number selection source

Syntax HY p1,p2<terminator>
 p1: Loop number (1 to 6) (1 or 2 on the CX1000)
 p2: SP number selection source (Off, On)

Example Turn On loop 1.
 HY1,ON

MY Turns Off/On the PV/SP computation

Syntax MY p1<terminator>
 p1: PV/SP computation function Off/On

Query MY?

MZ Sets the CLOG error

Syntax MZ p1<terminator>
 p1: CLOG error processing (skip, error)

Query MZ?

Output Processing
GF Sets the output processing

Syntax GF p1,p2,p3,p4<terminator>
 p1: Loop number (1 to 6) (1 or 2 on the CX1000)
 p2: Control output type*
 p3: Cycle time (1 to 1000)
 p4: Analog output-type
 (4-20 mA, 0-20 mA, 20-4 mA, 20-0 mA)
 *: Relay
 Voltage-pulse
 Current-output
 On/Off-control

Query GF [p1]?

Example Set the control output type of loop 4 to current output, cycle time to 600 s, and analog output type to 4-20 mA.
 GF4,CURRENT-OUTPUT,600,4-20MA

Relay
GR Sets relay parameters

Syntax GR p1,p2<terminator>
 p1: Enable/Disable the FAIL function (Off, On)
 p2: Enable/disable self diagnosis function (Off, On)

Query GR?

Example Turn Off the FAIL function and turn On the self diagnosis function
 GROFF,ON

GE Sets relay action

Syntax GE p1,p2,p3<terminator>
 p1: Module type*¹
 p2: Relay number*²
 p3: Relay action*³

*1: CTRL1-2, CTRL3-4, CTRL5-6
 EXTUDIO (CTRL1-2 only on the CX1000)

*2: DI001 to DI006
 DI101 to DI106
 DI201 to DI206
 RI001 to RI012 (expansion module)
 On the CX1000: DI001 to DI006

*3: De_energize/Hold, De_energize/
 Nonhold,
 Energize/Hold, Energize/Nonhold

Query GE [p1,p2]?

Example The relay number 10 of the expansion module to "Energize/Hold".
 GEEXTUDIO,RO010,ENERGIZE/HOLD

6.8 Basic Setting Commands (Control)

Tuning Setting

GU Turns Off/On the tuning item

Syntax GU p1 , p2 , p3 , p4 , p5 , p6 , p7 , p8 , p9
<terminator>

p1: Loop number (1 to 6, Ext1 to Ext16) (1 or 2, Ext1 to Ext4 on the CX1000)

p2: Item number (1 to 21)

p3: Item Off/On (Off, On)

p4: Item ID*

p5: Item name (alphanumeric characters)

p6: Register address (5- or 6-digit number) (cannot be specified for internal loops excluding "Others".)

p7: Decimal point position (0 to 4) (cannot be specified for internal loops)

p8: Control span low limit (cannot be specified for internal loops)

p9: Control span high limit (cannot be specified for internal loops)

*: For internal loops
SP, A1, A2, A3, A4, P, I, D, OH, OL, MR, H, DR, PO, SB1, FL1, SB2, FL2, RT, RBS, RFL, W01 to W36
For external loops
SP, A1, A2, A3, A4, P, I, D, OH, OL, MR, H, DR, DB, PO, ETC (if the connection model is set to "Other," only ETC is valid)

Query GU[p1 , p2]?

Example Set the item of internal loop 6 number 18 to Off.
GU6 , 18 , OFF
Set the item ID of internal loop1 number 21 to A1 and item name to "Item".
GU1 , 21 , ON , A1 , Item
Set the item ID of external loop 12 number 1 to ETC, item name to "etc", register address to 40003, decimal point position to 1, control span low limit to -10000, and high limit to 10000.
GUEXT12 , 1 , ON , ETC , etc , 40003 , 1 , -10000 , 10000

GJ External Loop Setting (Basic Setting) Specifies external loop

Syntax GJ p1 , p2 , p3 , p4 , p5 , p6 , p7 <terminator>

p1: Loop number (Ext1 to Ext16) (Ext1 to Ext4 on the CX1000)

p2: Communication Off/On (Off, On)

p3: Modbus address (1 to 247)

p4: Connection model*

p5: Loop select (First, Second)

p6: Tag (8 alphanumeric characters)

p7: Tag comment (8 alphanumeric characters)
*: UT320,UT350,UT420,UT450, UT520,UT550,UT750,Others

Query GJ[p1]?

Example Set communications of external loop 1 to On, Modbus address to 2, connection model to UT450, loop select to 1st loop, tag to "TAG1", and tag comment to "Ext1".
GJEXT1 , ON , 2 , UT450 , FIRST , TAG1 , Ext1

GK External loop parameter auto reading execute command

Syntax GK p1 , p2 <terminator>

p1: Loop number (Ext1 to Ext16) (Ext1 to Ext4 on the CX1000)

p2: Auto reading (1, 2, 3)
1: Basic settings
2: Parameter address
3: Tuning setting

Query GK[p1]?

Example Automatically read the basic settings of external loop 16.
GKEXT16 , 1

GV External loop parameter 4, parameter type/decimal point position and unit

Syntax GV p1 , p2 , p3 , p4 <terminator>

p1: Loop number (Ext1 to Ext16) (Ext1 to Ext4 on the CX1000)

p2: Parameter type (PV, SP, OUT)

p3: Decimal point position (0 to 4)

p4: Unit (6 alphanumeric characters)

Query GV[p1 , p2]?

Example Set the decimal point position of the input value of external loop 6 to 2 and the unit to A.
GVEXT6 , PV , 2 , A

GH External loop parameter 1, control span lower/upper limit

Syntax GH p1,p2,p3<terminator>
 p1: Loop number (Ext1 to Ext16) (Ext1 to Ext4 on the CX1000)
 p2: Control span lower
 p3: Control span upper

Query GH [p1]?

Example Set the control span lower limit of external loop 10 to 0, the upper limit to 20000.
 GHEXT10,0,20000

GQ External loop parameter 3, control mode/control output type

Syntax GQ p1,p2,p3<terminator>
 p1: Loop number (Ext1 to Ext16) (Ext1 to Ext4 on the CX1000)
 p2: Control mode*1
 p3: Control output type*2

*1: SingleLoopControl/
 CascadePrimaryLoop/
 CascadeSecondaryLoop/
 CascadeControl/ControlBackUp/
 PVSwitching/
 PVAutoSelector/PVHoldFunction/
 DualLoopControl/Temperature-Humidity/
 Cascade-2Uni/PVSwitching-2Uni/
 PVAutoSelector-2Uni

*2: Relay,Voltage-pulse,Current-output, On/Off-control

Query GQ [p1]?

Example Set the control mode of external loop 14 to 2 universal input PV auto selector and the control output type to On/Off-control relay contact output.
 GQEXT14,PVAutoSelector-2Uni, ON/OFF-CONTROL

GN External loop parameter 2, alarm number/alarm type

Syntax GN p1,p2,p3<terminator>
 p1: Loop number (Ext1 to Ext16) (Ext1 to Ext4 on the CX1000)
 p2: Alarm number (1 to 4) (numbers 1 to 3 are valid for UT320/UT350/UT420)

p3: Alarm type*1

*1: PV-High(Energ),PV-Low(Energ), Deviation-High(Energ), Deviation-Low(Energ), Deviation-High(Deenerg), Deviation-Low(Deenerg), Deviation-H&L(Energ), Dev-within-H&L(Energ), PV-High(Deenerg),PV-Low(Deenerg), PV-High(Energ/Standby), PV-Low(Energ/Standby), Dev-High(Energ/Standby), Dev-Low(Energ/Standby), Dev-High(Deenerg/Standby), Dev-Low(Deenerg/Standby), Dev-H&L(Energ/Standby), Dev-w-H&L(Energ/Standby), PV-High(Deenerg/Standby), PV-Low(Deenerg/Standby), Timer-upward(h:m),Timer-downward(h:m), Timer-upward(m:s),Timer-downward(m:s), Sensor-grounding,Problem-diagnostic, FAIL-output,SP-High,SP-Low, Output-High,Output-Low Heater-burnout1,Heater-burnout2

Query GN [p1,p2]?

Example Set external loop 11 alarm number 1 to PV high-limit alarm (deenergize/standby).
 GNEXT11,1,PV-HIGH(DEENERG/STANDBY)

External Loop Setting (Parameter Address Setting)**GW Sets the external loop parameter address**

Syntax GW p1,p2,p3<terminator>
 p1: Loop number (Ext1 to Ext16) (Ext1 to Ext4 on the CX1000)
 p2: Parameter type (PV, SP, OUT, Mode, R/L, S/R, Alarm, SP.No, PID.No,AT) (If the connecting model is "Other," parameters up to OUT are valid.)
 p3: Register address (30001 to 39999, 40001 to 49999, 300001 to 365535, 400001 to 465535)

Query GW [p1,p2]?

Example Set the register address of parameter PV of external loop 3 to 40003.
 GWEXT3,PV,40003

6.9 Control Commands

Control Commands

CA Switches between auto, manual, and cascade control

Syntax CA p1 , p2<terminator>
 p1: Switch between auto, manual, and cascade operation (0, 1, 2)
 0: Automatic switching
 1: Manual switching
 2: Cascade switching
 p2: Loop number (1 to 6) (1 or 2 on the CX1000)

Example Set the operation mode of loop 4 to cascade.
 CA2 , 4

OC Switches run/stop

Syntax OC p1 , p2<terminator>
 p1: Switch run/stop (0, 1)
 0: Stop
 1: Run
 p2: Loop number (1 to 6) (1 or 2 on the CX1000)

Example Switch loop 5 to run.
 OC1 , 5

RL Switches remote/local

Syntax RL p1 , p2<terminator>
 p1: Switch remote/local (0, 1)
 0: Local
 1: Remote
 p2: Loop number (1 to 6) (1 or 2 on the CX1000)

Example Set the input of loop 1 to remote.
 RL1 , 1

OS Stops/Starts control operation (common to all loops)

Syntax OS p1<terminator>
 p1: Stop control operation
 0: Stop
 1: Start

Example Start control operation.
 OS1

SN Switches target setpoint number

Syntax SN p1 , p2<terminator>
 p1: Target setpoint number SP (1 to 8)
 1 to 8: Target setpoint number 1 to target setpoint number 8
 p2: Loop number (1 to 6) (1 or 2 on the CX1000)

Example Set the target setpoint number of loop 5 to 8.
 SN8 , 5

PX Resets/Runs program

Syntax PX p1<terminator>
 p1: Switch reset/run (0, 1)
 0: RESET
 1: RUN

Example Start program operation
 PX1

HU Holds program operation

Syntax HU p1<terminator>
 p1: Hold program operation (0, 1)
 0: Release hold
 1: Hold

Example Hold the program operation.
 HU1

AD Advances program operation

Syntax AD p1<terminator>
 p1: Segment advance request during program operation (1)
 1: Segment advance request

Example AD1

PN Switches the pattern number

Syntax PN p1<terminator>
 p1: Program pattern number (1 to 30)
 1 to 30: Pattern number 1 to pattern number 30

Example Set the program pattern number to 10.
 PN10

HJ Changes the manual output setting

Syntax HJ p1 , p2<terminator>
 p1: Manual output setting (–50 to 1050 (–5.0 to 105.0%)). However, within the output high-limit and low-limit.
 p2: Loop number (1 to 6) (1 or 2 on the CX1000)

Example Set the manual output setting of loop 1 to 25.0%.
 HJ250 , 1

HV Requests auto tuning

Syntax HV p1 , p2<terminator>
 p1: Loop number (1 to 6) (1 or 2 on the CX1000)
 p2: 0 OFF
 1 Carry out PID number 1
 2 Carry out PID number 2
 3 Carry out PID number 3
 4 Carry out PID number 4
 5 Carry out PID number 5
 6 Carry out PID number 6
 7 Carry out PID number 7
 8 Carry out PID number 8
 9 all

Example Execute PID number 1 of loop 1.
 HV1 , 1

6.10 Output Commands (Measurement-Control)

BO Sets the byte output order

Syntax BO p1<terminator>
 p1: Byte order
 0: Outputs the data MSB first.
 1: Outputs the data LSB first.

Query BO?

Example Output the data MSB first.
 BO0

Description This command applies to the byte order of numerical data during BINARY output.

CS Sets the check sum

Syntax CS p1<terminator>
 p1: Enable/disable checksum
 0: Disable
 1: Enable

Query CS?

Example Enable check sum.
 CS1

Description Can be used only during serial communications.

IF Sets the status filter

Syntax IF p1<terminator>
 p1: Status filter value
 (0.0.0.0 to 255.255.255.255)

Query IF?

Example Set the status filter value to 1.0.4.0.
 IF1.0.4.0

Description For details, see chapter 7.

CC Disconnects Ethernet connection

Syntax CC p1<terminator>
 p1: Disconnect connection (0).

Example Disconnect the connection.
 CC0

Description Can be used only during Ethernet communications.

Note

Initialization of BO/CS/IF/CB command settings

• **For serial communications**

Settings entered using the BO/CS/IF/CB commands revert to their initial values when the CX is reset (when the CX is power cycled, or the user exits the basic setting mode).

- Byte output order, checksum, data output format: 0
- Status filter: 255.255.255.255

If you reset the CX, you must restore these settings.

• **For Ethernet communications**

Settings entered using the BO/IF/CB commands revert to their initial values when the connection to the CX is cut. After reconnecting the CX, you must reenter the settings.

6.11 Output Commands (Measurement-Setup, Measurement, and Computation Data Output)

FC Outputs the screen image data

Syntax FC p1<terminator>
 p1: GET (Output the screen image data)

Example Output the screen image data from the CX.
 FCGET

Description Captures the current displayed screen on the CX and outputs the data in PNG format.

FE Outputs the setup data

Syntax FE p1,p2,p3<terminator>
 p1: Output data type
 0 Setup data of setting commands
 1 Decimal point position and unit information
 2 Setup data of basic setting commands
 3 Newest decimal point and unit information of TLOG
 4 Setup data file

p2: First channel number (01 to 20, 31 to 60, 101 to 118, 201 to 248) (01 to 06, 31 to 42, 101 to 106, 201 to 212 on the CX1000)

p3: Last channel number (01 to 20, 31 to 60, 101 to 118, 201 to 248) (01 to 06, 31 to 42, 101 to 106, 201 to 212 on the CX1000)

Example Output the setup data of setting commands of channels 1 to 5 from the CX.
 FE0,01,05

Description

- Set the first channel number and last channel number parameters so that the last channel number is greater than or equal to the first channel number.
- Parameters p2 and P3 are valid when P1 is set to 0, 1, 2, or 3.
- This command cannot be used while setup data is being saved (specified using the LI command).
- The FE command with p1=4 cannot be used when setup data is being loaded (specified using the LO or YO command).
- The FE command with p1=4 cannot be used when the #1 Program parameter setting display under #7 Program-control parameters in Set mode is shown(or after sending the PB command).

6.11 Output Commands (Setup, Measurement, and Computation Data Output)

FD Outputs the newest measured/computed/control data

- Syntax** FD p1 , p2 , p3 <terminator>
- p1: Output data type
- 0 Output the newest measured/computed/control data in ASCII format
 - 1 Output the newest measured/computed/control data in BINARY format
 - 4 Output the newest TLOG data in ASCII format
 - 5 Output the newest TLOG data in BINARY format
- p2: First channel number (01 to 20, 31 to 60, 101 to 118, 201 to 248) (01 to 06, 31 to 42, 101 to 106, 201 to 212 on the CX1000)
- p3: Last channel number (01 to 20, 31 to 60, 101 to 118, 201 to 248) (01 to 06, 31 to 42, 101 to 106, 201 to 212 on the CX1000)
- Example** Output the newest measured/computed/control data of channels 1 to 5 from the CX in ASCII format.
- ```
FD0 , 01 , 05
```
- Description**
- The newest measured/computed/control data means the newest measured/computed/control data in the internal memory when the CX receives the FD command.
  - Set the first channel number and last channel number parameters so that the last channel number is greater than or equal to the first channel number.

### **FF** Outputs FIFO data

- Syntax** FF p1 , p2 , p3 , p4 <terminator>
- p1: Operation type
- GET Output from the next block after the previous output
  - RESEND Retransmit the previous output
  - RESET Set the newest data position (block) to the read position of the FIFO buffer (block)
  - GETNEW Output the newest data
- p2: First channel number (01 to 20, 31 to 60, 101 to 118, 201 to 248) (01 to 06, 31 to 42, 101 to 106, 201 to 212 on the CX1000)
- p3: Last channel number (01 to 20, 31 to 60, 101 to 118, 201 to 248) (01 to 06, 31 to 42, 101 to 106, 201 to 212 on the CX1000)
- p4: Upper limit of the number of blocks to be read
- 1 to 60
- If the measured/computed/control data is less than the specified number of blocks, the available amount of data is transmitted.

**Example** Output 2 blocks of FIFO data of channels 1 to 10.

```
FFGET , 01 , 10 , 2
```

- Description**
- The FIFO buffer is a cyclic buffer in which the oldest data is overwritten. Use the FR command to set the acquisition period.
  - The following formats for outputting FIFO data are available.
- Logging output (GET)
- Outputs the specified number of blocks (p4) of data from the next block after the block that was read previously.
- Read the data within the following buffer period to prevent dropouts from occurring.
- FIFO buffer length: 60 intervals (scan interval)
- Maximum buffer period: 60 × (acquisition period)
- Newest value output (GETNEW)
- Outputs the data from the newest data block back to the specified number of blocks (p4).
- Parameters p2 to p4 are valid when p1 is set to GET or GETNEW.
  - If you omit p4, all blocks are specified.
  - Set the first channel number and last channel number parameters so that the last channel number is greater than or equal to the first channel number.
  - For details on the output flow of the FIFO data, see appendix 4.

### **FL** Outputs log, alarm summary, and message summary

- Syntax** FL p1 , p2 <terminator>
- p1: Log type
- |       |                 |
|-------|-----------------|
| COM   | Communications  |
| FTPC  | FTP client      |
| ERR   | Operation error |
| KEY   | Key login       |
| WEB   | Web operation   |
| EMAIL | E-mail          |
| ALARM | Alarm summary   |
| MSG   | Message summary |
- p2: Maximum read length of the log
- When p1 is COM 1 to 200
  - When p1 is ALARM 1 to 120
  - When p1 is MSG 1 to 100
  - When p1 is some type other than the above 1 to 50
- Example** Output the ten newest operation error logs.
- ```
FLERR , 10
```
- Description**
- Outputs the log that is saved in the CX.
 - If p2 is omitted, all written logs are output.

FS Outputs alarm kind and alarm setting value for measurement/computation/control channel

Syntax FS p1,p2<terminator>
 p1: Top channel number (01-20/31-60/101-118/201-248,, or 01-06/31-42/101-106/201-212 for the CX1000)
 p2: Last channel number (01-20/31-60/101-118/201-248,, or 01-06/31-42/101-106/201-212 for the CX1000)
 However, p1 <= p2

Example Outputs alarm kind and alarm setting value for control channels 101–110.
 FS101,110

FT Outputs max/min/decimal point of span for measurement/computation/control channel

Syntax FT p1,p2<terminator>
 p1: Top channel number (01-20/31-60/101-118/201-248,, or 01-06/31-42/101-106/201-212 for the CX1000)
 p2: Last channel number (01-20/31-60/101-118/201-248,, or 01-06/31-42/101-106/201-212 for the CX1000)
 However, p1 <= p2

Example Outputs max/min/decimal point of span for control channels 101–110.
 FT101,110

IS Outputs status information

Syntax IS p1<terminator>
 p1: Output status information (0)

Example Output status information.
 IS0

Description The output status can be masked using the status filter (IF command).

FU Outputs the user level

Syntax FU p1<terminator>
 p1: Output user information (0)

Example Output user information.
 FU0

Description Outputs the information of the user currently connected to the CX.

ME Outputs the data stored on the external storage medium

Syntax ME p1,p2,p3<terminator>
 p1: Operation type
 DIR Output the file list
 GET Output (first time)
 NEXT Output (succeeding times).
 This parameter is used to output the remaining data when the first output operation is not adequate.
 RESEND Retransmit the previous output
 DEL Delete
 DIRNEXT Outputs the succeeding file list after the file list is output using the DIR command. The number of output lists is the p3 value specified with the DIR command. If this command is executed after all lists have been output, only the free space of the storage medium is output.

p2: File name (up to 26 characters)
 Specify using a full path.

p3: The maximum number of file lists to be output (1 to 100).
 All file lists in the specified directory are output when omitted.

Example

- Output the list of all files in the root directory.
 MEDIR, /
- Output 10 files of the file list of the root directory.
 MEDIR, /, 10
- Output the list of all files in the DATA0 directory.
 MEDIR, /DATA0/*.*
- Output the list of all display data files in the DATA0 directory.
 MEDIR, /DATA0/*.CDS
- Output the data in the file 72615100.CDS in the DATA0 directory.
 MEGET, /DATA0/72615100.CDS

Description

- Parameter p2 is valid when p1 is set to DIR, GET, or DEL.
- Parameter p3 is valid when p1 is set to DIR.
- This command can be used to output data over the communication interface (Ethernet or serial) that was selected with the XO command.
- If an error occurs during data transmission, (p1=) RESEND can be used to retransmit the data.

6.11 Output Commands (Setup, Measurement, and Computation Data Output)

MI Outputs display data and event data in the internal memory

Syntax `MI p1 , p2 , p3 , p4<terminator>`

p1: Operation type

- DIR Put the data on standby for communication output and output data list
- GET Output (first time)
- NEXT Output (succeeding times). This parameter is used to output the remaining data when the first output operation is not adequate.
- RESEND Retransmit the previous output
- SIZE Output the data size (capacity)

p2: Output data type

- DISPLAY Display data
- EVENT Event data

p3: Block number (1 to 16)

p4: Output format (FILE, DATA)

Example Output the data in block number 1 containing display data using the file output format.

```
MIGET, DISPLAY, 1, FILE
```

Description

- Parameter p2 is valid when p1 is set to DIR, GET, or SIZE.
- Parameters p3 and p4 are valid when p1 is set to GET or SIZE.
- This command can be used to output data over the communication interface (Ethernet or serial) that was selected with the XO command.
- This command outputs the data, which have been put on standby using (p1=) DIR, using (p1=) GET. Make sure to put the data on standby using DIR before outputting the data using GET.

MO Outputs TLOG data, manual sample data, and report data in the internal memory

Syntax `MO p1 , p2 , p3<terminator>`

p1: Operation type

- DIR Put the data on standby for communication output and output data list
- GET Output (first time)
- NEXT Output (succeeding times). This parameter is used to output the remaining data when the first output operation is not adequate.
- RESEND Retransmit the previous output
- SIZE Output the data size (capacity)

p2: Output data type

- TLOG TLOG data
- MANUAL Manual sampled data
- REPORT Report

p3: Block number

- When p2 is set to TLOG 1 to 16
- When p2 is set to MANUAL 1 to 50
- When p2 is set to REPORT 1 to 40

Example Output the data in block number 1 containing TLOG data from the CX.

```
MOGET, TLOG, 1
```

Description

- Parameter p2 is valid when p1 is set to DIR, GET, or SIZE.
- Parameter p3 is valid when p1 is set to GET or SIZE.
- This command can be used to output data over the communication interface (Ethernet or serial) that was selected with the XO command.
- This command outputs the data, which have been put on standby using (p1=) DIR, using (p1=) GET. Make sure to put the data on standby using DIR before outputting the data using GET.

6.12 Output Commands (Measurement-RS-422/485 Dedicated Commands)

ESC O Opens the device

ESC is the character 1BH expressed using ASCII code. See appendix 1.

Syntax ESC O p1<terminator>

p1: Device address (01 to 32)

Example Open the device at address 01, and enable all commands.

ESC O01

- Description
- Specifies the address of the device with which to communicate.
 - Only one device can be opened at any given time.
 - When the ESC O command is executed, any other device that is currently open is automatically closed.
 - When this command is received correctly, the CX transmits the data "ESC O □ □".
 - Normally, either CR+LF or LF can be used as a terminator for communication commands. However, the terminator for this command must be set to CR+LF.

ESC C Closes the device

ESC is the character 1BH expressed using ASCII code. See appendix 1.

Syntax ESC C p1<terminator>

p1: Device address (01 to 32)

Example Close the device whose address is 01.

ESC C01

- Description
- Clears the current connection with the connection.
 - When this command is received correctly, the CX transmits the data "ESC C □ □".
 - Normally, either CR+LF or LF can be used as a terminator for communication commands. However, the terminator for this command must be set to CR+LF.

6.13 Output Commands (Control)

FP Outputs the SP number and PID number.

Syntax FP p1<terminator>

p1: Loop number (1 to 6 (1 or 2 on the CX1000))

Query FP?

Example Output the SP number and PID number of loop number 2.

FP2

Description Outputs the SP number and PID number that is currently used by the selected loop.

FM Outputs the control mode.

Syntax FM p1<terminator>

p1: Loop number (1 to 6 (1 or 2 on the CX1000))

Query FM?

Example Output the control mode of loop number 2.

FM2

Description Outputs the status of the control mode of the selected loop. The status is indicated using 32 bits that are divided into 4 groups of 8 bits.

xxx.xxx.xxx.xxx

For details, see "Control Mode Output" in section 7.2, "ASCII Data Output Format."

FH Outputs the program operation mode.

Syntax FH p1<terminator>

p1: Program parameter numbers (1–30)

1–30: pattern number 1 to pattern number 30

When omitted, assumes the pattern numbers designated on the CX.

Example Outputs the status of pattern number 2's program operation mode

FH2

Description The status of the operation mode of the selected pattern is output. The status is indicated using 32 bits that are divided into 4 groups of 8 bits.

xxx.xxx.xxx.xxx

For details, see "Program Operation Mode Output" in section 7.2, "ASCII Data Output Format."

6.13 Output Commands (Control)

FJ Outputs program pattern information that is currently in execution.

Syntax FJ<terminator>

Example FJ

Description Outputs program pattern information that is currently in execution. If a program pattern is not currently in execution, information about the last pattern that was executed at the time of termination is output. In this case, the remaining segment time (SEGTM) and wait time of wait action (WAITTM) are zeroes. For details, see “Output of Program Pattern Information Currently in Execution” in section 7.2, “ASCII Data Output Format.”

FK Outputs PV event/time event information.

Syntax FK p1<terminator>

p1: Program parameter numbers (1–30)
1–30: pattern number 1 to pattern number 30
When omitted, assumes the pattern numbers designated on the CX.

Example Outputs the status of pattern number 2’s program operation mode
FK2

Description • Outputs the status of the current PV event and time event when program operation is in progress. When program operation is not in progress, zeroes are output for the statuses of the PV event and time event.

- The statuses of the PV event and time event are output separately. The status is indicated using 32 bits that are divided into 4 groups of 8 bits.

xxx.xxx.xxx.xxx (PV event)
yyy.yyy.yyy.yyy (Time event)

For details, see “Output of PV Event and Time Event Information” in section 7.2, “ASCII Data Output Format.”

FN Output of DI/DO data and internal switch status

Syntax FN<terminator>

Example FN

Description • Outputs the status of control DIO, expansion DIO (CX2000), and internal switches.
• Outputs the status of control DIO, EXTDIO (CX2000), and internal switches in binary. For the output format, see section 7.3, “DI/DO Data and Internal Switch Status” under “Output Format of BINARY Data.”

FO Output of status of DIO operation monitoring function

Syntax FO<terminator>

Example FO

Description Outputs the status of the DIO monitoring function in binary. For the output format, see section 7.3, “DIO Monitoring Function Status” under “Output Format of BINARY Data.”

FW Output of pattern numbers, operation status, and loops assigned to patterns

Syntax FW<terminator>

Example FW

Description Outputs pattern numbers, operation status, and loops assigned to patterns in binary. For the output format, see section 7.3, “Output of Pattern Numbers, Operation Status, and Loop Numbers Assigned to Patterns” under “Output Format of BINARY Data.”

DQ Outputs the SP number and PID number of external loops

Syntax DQ p1<terminator>

p1: Loop numbers (1–12, or 1–4 on the CX1000)

Query DQ?

Example Outputs the SP and PID number of loop number 2.
DQ2

Description With the selected external loop, the currently used SP number and PID numbers are output.

DR Output of control mode of external loops

Syntax DR p1<terminator>

p1: Loop numbers (1–12, or 1–4 on the CX1000)

Query DR?

Example Outputs the control mode of loop number 2.
DR2

Description The status of the control mode of the selected external loop is output. The status of each of 32 bits, delimited in groups of 4, is displayed every 8 bits.

xxx.xxx.xxx.xxx

For details, see section 7.2, “Control Mode Output” under “Output Format of ASCII Data.”

FV Outputs the status of the program control end signal.

- Syntax** FV p1<terminator>
 p1: Program parameter numbers (1–30)
 1–30: pattern number 1 to pattern number 30
 When omitted, assumes the pattern numbers designated on the CX.
- Example** Outputs the status of pattern number 2's program control end signal
 FV2
- Description** The program control end signal is turned "ON" for approximately 5 s after the program control terminates normally. It does not turn "ON" if the program is forcibly terminated (termination through resetting). You can assign the program control end signal to a contact output and have the contact turned "ON" for approximately 5 s after the program control terminates normally. You can use the FV command to output the status of the program control end signal.

6.14 Maintenance/Test Commands (Available when using the maintenance/test server function via Ethernet communications)**close** Disconnects the connection between other devices

- Syntax** close,p1,p2:p3<terminator>
 p1: Port on the DX side (1 to 65535)
 p2: IP address on the PC side
 (0.0.0.0 to 255.255.255.255)
 p3: Port on the PC side (1 to 65535)
- Example** close,34159,192.168.111.24:1054
 E0

Description This command cannot be used to disconnect a server port. In addition, it cannot disconnect the device being operated. Use the quit command for this purpose.

con Outputs connection information

Syntax con<terminator>

Example

```
con
EA
00/00/00 12:34:56
Active connections
Proto Local Address          Foreign Address      State
TCP   192.168.111. 24:34159  192.168.111. 24:1053 ESTABLISHED
TCP   0. 0. 0. 0:34155   0. 0. 0. 0: 0 LISTEN
TCP   0. 0. 0. 0:34159   0. 0. 0. 0: 0 LISTEN
TCP   0. 0. 0. 0:34150   0. 0. 0. 0: 0 LISTEN
EN
```

TCP

Protocol used.

Local Address

The CX's socket address.

Displays "IP address:port number."

Foreign Address

The destination socket address.

Displays "IP address:port number."

State

Connection status.

ESTABLISHED

Connection established.

6.14 Maintenance/Test Commands

eth **Outputs Ethernet statistical information**

Syntax eth<terminator>

Example

```
eth
EA
00/00/00 12:34:56
Ethernet Statistics
Name  In Pkt  In Err  Out Pkt  Out Err16  Coll
lo0   0      0      0        0          0
mb0   74     0      64       0          0
EN
```

help **Outputs help**

Syntax help [,p1]<terminator>
p1 Command name
 (close, con, eth, help, net, quit)

Example help
 EA
 con - echo connection information
 eth - echo ethernet information
 help - echo help
 net - echo network status
 quit - close this connection
 EN

net **Outputs network statistical information**

Syntax net<terminator>

Example net
 EA
 00/00/00 12:34:56
 Network Status
 APP: power on time = 00/00/00
 12:34:56
 APP: applalive = disable
 APP: genedrops = 0
 APP: diagdrops = 0
 APP: ftpsdrops = 0
 TCP: keepalive = 30 s
 TCP: connects = 14
 TCP: closed = 0
 TCP: timeoutdrop = 0
 TCP: keepdrops = 0
 TCP: sndtotal = 53
 TCP: sndbyte = 0
 TCP: sndrexmitpack = 0
 TCP: sndrexmitbyte = 1
 TCP: rcvtotal = 0
 TCP: rcvbyte = 0
 DLC: 16 collisions = 0
 EN

TCP: keepalive
 Keepalive check cycle.

TCP: connects
 Total number of connections established.

TCP: closed
 Total number of dropped connections.

TCP: timeoutdrop
 Total number of dropped connections due to TCP retransmission timeout. If the transmitted packet (the unit of transmitted data) is not received, the packet is automatically retransmitted at a predetermined time interval. If the packet is not received after 14 retransmissions, timeout occurs and the connection is dropped.

TCP: keepdrops
 Total number of dropped connections due to TCP keepalive timeout.

TCP: sndtotal
 Total number of transmitted packets.

TCP: sndbyte
 Total number of transmitted bytes.

TCP: sndrexmitpack
 Total number of retransmitted packets.

TCP: sndrexmitbyte
 Total number of retransmitted bytes.

TCP: rcvtotal
 Total number of received packets.

TCP: rcvbyte
 Total number of received bytes.

DLC: 16 collisions
 Number of collision incidents. A collision occurs when two or more devices on the network attempt to transmit simultaneously. The tendency for collisions to occur increases when the network is congested. 16 collisions would mean 16 consecutive collision incidents.

quit **Disconnects the connection of the device being operated**

Syntax quit<terminator>

6.15 Instrument Information Output Commands (Available when using the instrument information server function via Ethernet communications)

The instrument information server function interprets one UDP packet to be one command and returns a single packet (containing the CX information) in response to the command.

Port number	34264/udp (see section 2.1)
Transfer data	ASCII
Received buffer length	128
Transmit buffer length	512
Maximum number of parameters	32

In the command packet, parameters corresponding to the desired information are placed one after another.

Parameter	Description
<code>all</code>	Outputs all information that is output using the parameters below (serial, model, host, ip).
<code>serial</code>	Outputs the serial number.
<code>model</code>	Outputs the manufacturer, model, and firmware version.
<code>host</code>	Outputs the host name (the host name specified in section 2.3).
<code>ip</code>	Outputs the IP address (the host name specified in section 2.3).

Example Query the IP address and host name. (Of the two frames below, the top frame represents the command packet, the bottom frame represents the response packet.)

```
ip host

EA
ip = 192.168.111.24
host = CX2000
EN
```

Description

- Separate each parameter with one or more blanks (space, tab, carriage return, line feed).
- Parameters are not case sensitive.
- Undefined parameters will be ignored.
- Parameters beyond the 32nd parameter are ignored.

7.1 Response Syntax

The following table shows the types of responses for the various commands described in the previous chapter.

The CX returns a response (affirmative/negative response) to a command that is delimited by a single terminator. The controller should follow the one command to one response format. When the command-response rule is not followed, the operation is not guaranteed.

Function	Command		Response		
		Command Type	Affirmation	Negation	
Setting/ Measurement Server	Setting command		Affirmative response	Single negative response or multiple negative responses	
	Basic setting command				
	Output command	Measurement	Control		ASCII output
			Setup, measured, and computed data output		BINARY output
		Control	ASCII output		
		RS-422/485 dedicated	Dedicated response	No response	

* For the responses to the instrument information server function, see section 7.4.

Note

The "CRLF" used in this section denotes carriage return line feed.

Affirmative Response

When the command is processed correctly, an affirmative response is returned.

Syntax

E0CRLF

Example

E0

Single Negative Response

When the command is not processed correctly, a single negative response is returned.

Syntax

E1_nnn_mmm...mCRLF

nnn Error number (001 to 999)

mmm...m Message (variable length, one line)

_ Space

Example

E1 001 "Ststem error"

Multiple Negative Responses

- If there is an error in any one of the multiple commands that are separated by sub delimiters, multiple negative responses are returned.
- The response is generated for each erroneous command.
- If there are multiple commands that have errors, the negative responses are separated by commas.
- The error position number is assigned to the series of commands in order starting with "1" assigned to the first command.

Syntax

E2_ee:nnnCRLF (When there is only one error)

E2_ee:nnn,ee:nnn,...,ee:nnnCRLF (When there are multiple errors)

ee Error position (01 to 10)

nnn Error number (001 to 999)

_ Space

Example

E2 02:001

ASCII Output

The following types of ASCII data are available. For a description of the data formats, see section 7.2.

Setting/basic setting data, decimal point position/unit information, measured/computed/control data, SP number and PID number, control mode, program operation mode, program pattern information that is currently in execution, PV event/time event information, status of the program control end signal, communication log, FTP log, operation error log, key login log, Web operation log, e-mail log, alarm summary, message summary, status information, file list, data list, and user level

Syntax

```
EACRLF
.....CRLF
:
.....CRLF
.....CRLF
ENCRLF
```

BINARY Output

Conceptual Diagram

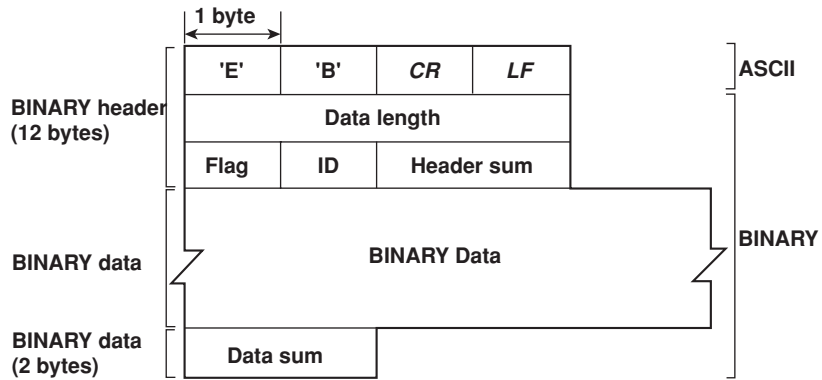

EBCRLF

Indicates that the data is BINARY.

Data Length

The byte value of “flag + identifier + header sum + BINARY data + data sum.”

Header Sum

The sum value of “data length + flag + identifier.”

BINARY Data

For details on the output format of various data types, see section 7.3.

Data Sum

The sum value of “BINARY data.”

Note

The data length of the BINARY header section is output according to the byte order specified with the BO command.

Flag

Bit	Name (Abbreviation)	Flag		Meaning of the Flag
		0	1	
7	BO	MSB	LSB	Output byte order
6	CS	No	Yes	Presence of checksum
5	–	–	–	
4	–	–	–	
3	–	–	–	
2	–	–	–	
1	–	–	–	
0	END	Middle	End	In the middle or at the end of the continuous data

- When the BO flag is “0,” the MSB is output first. When the BO flag is “1,” the LSB is output first.
- If the check sum is enabled (parameter = 1) using the CS command parameter, each sum value is inserted in the header sum and data sum sections in the “Conceptual Diagram” on the previous page. If the check sum is disabled (parameter = 0), a zero is inserted in the header sum and data sum sections. For a sample program that calculates the sum value, see “Calculating the Sum Value” on the next page.
- If the amount of data output in response to a ME, MI, or MO command is large, not all the data may be returned in one output request (parameter GET). In this case the END flag becomes “0.” You must send output requests (parameter NEXT) to receive the rest of the data until the END flag becomes “1.”
- The bits that have “–” for the name and flag are not used. The value is undefined.

Identifier

ID Number	BINARY Data	Type	Format
0	Undefined file	file (*.*)	–
1	Trigger data	data	Yes
1	Measured/computed data	data	Yes
1	FIFO data	data	Yes
2	Display data file	file (*.cds)	No
3	Event data file	file (*.cev)	No
4	Manual sampled data file	file (*.dmn)	Yes
5	Hourly report data file	file (*.dhr)	Yes
6	Daily report data file	file (*.ddr)	Yes
7	Weekly report data file	file (*.dwr)	Yes
8	Monthly data file	file (*.dmr)	Yes
9	TLOG data file	file (*.dtg)	No
10	Setup data file	file (*.pcl)	No
11	Display data	data	Yes
12	Event data	data	Yes
13	Screen image data	file (*.png)	–

Yes: disclosed, No: undisclosed, –: common format

- The table above shows the different types of BINARY Data.
- BINARY data comes in two types, data and file.
 - **Data**
 - Measured/computed data can be output using the FD command.
 - FIFO data can be output using the FF command.
 - Display data or event data can be output using the MI command.
 - The data format is disclosed. See section 7.3.
 - **File**
 - Display data, event data, TLOG data, and setup data files can be used on the DAQSTANDARD software that came with the package. For details, see the DAQSTANDARD software manual (IM04L31A01-61E).
 - Files that are in common formats can be opened using software programs that are sold commercially.
 - Other formats are written in ASCII code. A text editor can be used to open these types of files.
 - The identifier section in the “Conceptual Diagram” on the previous page contains the ID number that indicates the BINARY Data type.

Note

BINARY data that are not indicated in the above table are considered undefined files.

Calculating the Sum Value

If you set the parameter of the CS command to “1 (enabled),” the checksum value is output only during serial communications. The check sum is the same as that used in the TCP/IP and is derived according to the following algorithm.

Buffer on Which the Sum Value Is Calculated

- For the header sum, it is calculated from “data length + flag + identifier” (fixed to 6 bytes).
- For the data sum, it is calculated from “BINARY data.”

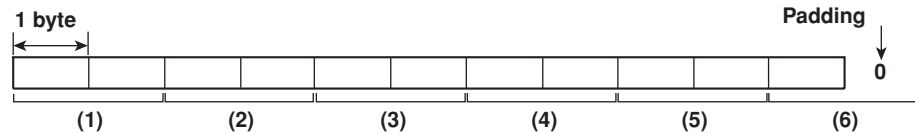

If the data length of the buffer is odd, a “0” is padded so that it is even. (1) through (6) are summed as unsigned two-byte integers (unsigned short). If the digit overflows a “1” is added. Finally, the result is bit-wise inverted.

Sample Program

The sum value is determined using the following sample program, and the calculated result is returned. The sum determined by the sample program can be compared with the header sum of the output BINARY header section and the data sum of the output BINARY footer section.

```

/*
 * Sum Calculation Function (for a 32-bit CPU)
 *
 * Parameter buff : Pointer to the top of the data on which the sum is
 *                  calculated
 *          len : Length of the data on which the sum is calculated
 * Returned value : Calculated sum
 */
int cksum(unsigned char *buff, int len)
{
    unsigned short *p;          /* Pointer to the next two-byte data word in the
                                buffer that is to be summed. */
    unsigned int  csum;        /* Checksum value */
    int          i;
    int          odd;
    csum = 0;                  /* Initialize. */
    odd = len%2;              /* Check whether or not the number of data points
                                is even. */
    len >>= 1;                /* Determine the number of data points using a
                                "short" data type. */
    p = (unsigned short *)buff;
    for(i=0;i<len;i++)        /* Sum using an unsigned short data type. */
        csum += *p++;
    if(odd){                  /* When the data length is odd */
        union tmp{            /* Pad with a 0, and add to the unsigned short
                                data. */
            unsigned short s;
            unsigned char  c[2];
        }tmp;
        tmp.c[1] = 0;
        tmp.c[0] = *((unsigned char *)p);
        csum += tmp.s;
    }
    if((csum = (csum & 0xffff) + ((csum>>16) & 0xffff)) > 0xffff)
        /* Add the overflowed digits */
        csum = csum - 0xffff; /* If the digit overflows again, add a 1. */
    return((~csum) & 0xffff); /* bit inversion */
}

```

RS-422/485 Dedicated Commands and Responses

The following table shows dedicated commands for the RS-422/485 interface and their responses.

Command Syntax	Meaning	Response
<i>ESC O_xx CRLF</i> (_ space)	Open the device	<ul style="list-style-type: none"> Response from the device with the specified address <i>ESC O_xx CRLF</i> Response when the instrument with the specified address does not exist* None
<i>ESC C_xx CRLF</i> (_ space)	Close the device	<ul style="list-style-type: none"> Response from the device with the specified address <i>ESC C_xx CRLF</i> Response when the instrument with the specified address does not exist* None

* Possible reasons that cause the condition “The instrument with the specified address does not exist” are command errors, the address not matching that of the instrument, the instrument is not being turned ON, and the instrument not being connected via the serial interface.

- The “xx” in the table indicates the device address. Specify the address that is assigned to the instrument from 01 to 32.
- Only one device can be opened at any given time.
- When a device is opened with the ESC O command, all commands on the device become active.
- When a device is opened with the ESC O command, any other devices that are open are automatically closed.
- Normally, either CR+LF or LF can be used as a terminator for communication commands. However, the terminator for these commands must be set to CR+LF.

Note

ESC is the character 1BH expressed using ASCII code. See appendix 1.

7.2 Output Format of ASCII Data

The following types of ASCII data are available. The format for each type is described in this section.

- Setting/basic setting data
- Decimal point position/unit information
- Measured/computed/control data
- SP number and PID number
- Control mode
- Program operation mode
- Program pattern information that is currently in execution
- PV event/time event information
- Status of the program control end signal
- Communication log
- FTP log
- Operation error log
- Key login log
- Web operation log
- E-mail log
- Alarm summary.
- Message summary
- Status information
- File list
- Data list
- User level

Note

The “*CRLF*” used in this section denotes carriage return line feed.

Setting Data/Basic Setting Data

- The FE command is used to output the data.
- The setting/basic setting data are output in the order of the listed commands in the table in section 6.2, "A List of Commands." However, the setting information for the following commands is not output.
 - **Setting commands (setup)**
SD/FR command
 - **Setting commands (control)**
All commands from UD to CM
 - **Basic setting commands**
XE, YO, YI, and YC commands
- The output format of the setting/basic setting data conforms to the syntax of each command.
- Some commands are output in multiple lines. Commands that are specified for each channel are such commands.

Syntax

The two-character command name and the succeeding parameters are output in the following syntax.

```
EACRLF
ttsss...sCRLF
.....
ENCRLF
```

```
tt          Command name(SR, SA..., XA, XI...)
sss...s    Setting, basic setting data (variable length, one line)
```

Example

```
EA
SR01,VOLT,20mV,0,20
SR02,VOLT,20mV,0,20
.....
EN
```

Decimal Point Position/Unit Information

- The FE command is used to output the data.

Syntax

The data is output for each channel in the following syntax.

EACRLF

s_ccccuuuuuu,ppCRLF

.....

ENCRLF

<i>s</i>	Data status (N, D, S) N: Normal D: Differential input S: Skip (When the measurement range is set to SKIP for a measurement channel or when the channel is turned OFF for a computation channel)
<i>ccc</i>	Channel number 0xx: Measurement channel (001 to 020) (001 to 006 on the CX1000) Axx: Computation channel (A31 to A60) (A31 to A42 on the CX1000) 1xx: Internal control channel (101 to 118) (101 to 106 on the CX1000) 2xx: External control channel (201 to 248) (201 to 212 on the CX1000)
<i>uuuuuu</i>	Unit information (6 characters, left-justified) mV____: mV V____: V ^C____: °C xxxxxx: (User-defined character string)
<i>pp</i>	Decimal point position (00 to 04) No decimal point (00000) for 00. One digit to the right of the decimal (0000.0) for 01. Two digits to the right of the decimal (000.00) for 02. Three digits to the right of the decimal (00.000) for 03. Four digits to the right of the decimal (0.0000) for 04.
<i>_</i>	Space

Example

```
EA
N 001mV ,01
N 002mV ,01
EN
```

Measured/Computed/Control Data

- The FD command is used to output the data.

Syntax

The measured/computed/control data is output in the following syntax along with the date and time information for each channel.

```
EACRLF
DATE_YY/mo/ddCRLF
TIME_hh:mi:ss.mmmtCRLF
s_ccca1a1a2a2a3a3a4a4uuuuuufdddddE-ppCRLF
.....
ENCRLF
```

yy	Year (00 to 99)
mo	Month (01 to 12)
dd	Day (01 to 31)
hh	Hour (00 to 23)
mi	Minute (00 to 59)
ss	Second (00 to 59)
mmm	Millisecond (000 to 999. A period is placed between seconds and milliseconds.)
t	Reserved (Space.)
s	Data status (N, D, S, O, E) N: Normal D: Differential input S: Skip O: Over E: Error
ccc	Channel number 0xx: Measurement channel (001 to 020) (001 to 006 on the CX1000) Axx: Computation channel (A31 to A60) (A31 to A42 on the CX1000) 1xx: Internal control channel (101 to 118) (101 to 106 on the CX1000) 2xx: External control channel (201 to 248) (201 to 212 on the CX1000)
a1a1a1a2a2a2a3a3a3a4a4a4	
a1a1a1	Alarm status (level 1)
a2a2a2	Alarm status (level 2)
a3a3a3	Alarm status (level 3)
a4a4a4	Alarm status (level 4)

(Set to one of the following alarms.
H (high limit alarm), L (low limit alarm), h (difference high-limit alarm), l (difference low-limit alarm), R (high limit on rate-of-change alarm), r (low limit on rate-of-change alarm), T (delay high limit alarm), t (delay low limit alarm), PVH (PV high-limit alarm), PVL (PV low-limit alarm), DVH (deviation high-limit alarm), DVL (deviation low-limit alarm), DVO (deviation high & low limit alarm), DVI (deviation within high & low limits alarm), SPH (SP high-limit alarm), SPL (SP low-limit alarm), OTH (output high-limit alarm), OTL (output low-limit alarm), ETC (other alarm), space (no alarm)

7.2 Output Format of ASCII Data

uuuuuu	Unit information (6 characters, left-justified) mV____: mV V____: V ^C____: °C xxxxxx: (User-defined character string)
f	Sign (+, -)
ddddd	Mantissa (00000 to 99999, 5 digits) <ul style="list-style-type: none">• 8 digits for computed data.• For abnormal data (data status is E) or data of which the mantissa or the exponent exceeds the range (data status is O), the mantissa is set to 99999 (99999999 for computed data).
pp	Exponent (00 to 04)
_	Space

Example

```
EA
DATE 99/02/23
TIME 19:56:32.500
N 001h   mV   +12345E-03
N 002   mV   -67890E-01
S 003
EN
```

Note

- Data for non-existing channels is not output (not even the channel number).
 - For channels set to skip, output values from alarm status to exponent are spaces.
-

SP Number and PID Number

- Output data using an FP command for internal loops, or a DQ command for external loops.
- The SP number and PID number that are currently used by the selected loop are output.

Syntax

The SP number is output followed by the PID number.

```
EACRLF
SPNO_xCRLF
PIDNO_yCRLF
ENCRLF
x          SP number (1 to 8)
y          PID number (1 to 8)
_          Space
```

Example

```
EA
SPNO 1
PIDNO 2
EN
```

Control Mode Output

- Output data using an FM command for internal loops, or a DR command for external loops..
- The status of the control mode of the selected loop is output. The status is indicated using 32 bits that are divided into 4 groups of 8 bits.

Syntax

EACRLF

xxx . xxx . xxx . xxxCRLF

ENCRLF

xxx

The statuses of bits 31 to 24, 23 to 16, 15 to 8, and 7 to 0 are indicated in order in decimal notation.



- The status of each bit indicates the status of each control mode.
 - Bit 0 status 0: stop, 1: run
 - Bit 1 status 0: local, 1: remote
 - Bit 2 status 0: auto, 1: manual
 - Bit 3 status 0: Not in cascade (cas) control
 1: In cascade control
 - Bit 4 status 0: Not auto tuning (AT)
 1: Auto tuning
 - Bit 31 status 0: Not in program operation, 1: In program operation
- When bit 3 is 1 (in cascade control), the secondary loop of the cascade can be in any of the statuses auto, manual, or cas. The primary loop of the cascade is fixed to auto.

Example

When in program operation, auto tuning, in cascade control, auto, remote, and run.

EA

128.000.000.027

EN

Program Operatin Mode Output

- The FH command is used to output the data.
- The status of the program operation mode is output. The status is indicated using 32 bits that are divided into 4 groups of 8 bits.

Syntax

```
EACRLF
xxx . xxx . xxx . xxxCRLF
ENCRLF
```

xxx The statuses of bits 31 to 24, 23 to 16, 15 to 8, and 7 to 0 are indicated in order in decimal notation.



The status of each bit indicates the status of the program operation mode.

- Bit 0 status 0: reset, 1: Frun
- Bit 1 status 0: Not holding, 1: Holding
- Bit 2 status 0: Not waiting, 1: Waiting

Example

```
When not waiting, not holding, and reset
EA
000.000.000.000
EN
```

Output of Program Pattern Information Currently in Execution

- The FJ command is used to output the data.
- The information about the program pattern that is currently in execution is output.

Syntax

```
EACRLF
PTNO_x1CRLF
SEGNO_x2CRLF
PRE_SEGNO_x3CRLF
SEGUSE_x4CRLF
SEGTM_hh:mi:ssCRLF
WAITTM_hh:mi:ssCRLF
RCYMOD_x5CRLF
ALL_RCY_x6CRLF
REM_RCY_x7CRLF
RST_x8CRLF
REN_x9CRLF
PTN_START_DATE_yy/mo/ddCRLF
PTN_START_TIME_hh:mi:ssCRLF
PTN_STOP_DATE_yy/mo/ddCRLF
PTN_STOP_TIME_hh:mi:ssCRLF
ENCRLF
```

PTNO	Pattern number in operation x1 (1 to 30)
SEGNO	Segment number in operation x2 (1 to 99)
PRE_SEGNO	Segment number used previously x3 (1 to 99)
SEGUSE	Number of segments of the currently selected pattern x4 (1 to 99)
SEGTM	Remaining segment time
hh	Hour (00 to 99)
mi	Minute (00 to 59)
ss	Second (00 to 59)
WAITTM	Wait time during wait action
hh	Hour (00 to 99)
mi	Minute (00 to 59)
ss	Second (00 to 59)
RCYMOD	Repeat setting of the pattern in operation x5 (0: OFF, 1: ON, 2: repeat infinite number of times)
ALL_RCY	Repeat count of the pattern in operation x6 (0 to 999) A valid value is indicated when RCYMOD is "1."
REM_RCY	Remaining repeat count of the pattern in operation x7 (0 to 999) A valid value is indicated when RCYMOD is "1."
RST	Start segment number for repeat action x8 (1 to 99)
REN	End segment number for repeat action x9 (1 to 99)
PTN_START_DATE/PTN_START_TIME	Program operation start date/time
YY	Year (00 to 99)
mo	Month (01 to 12)
dd	Day (01 to 31)
hh	Hour (00 to 23)
mi	Minute (00 to 59)
ss	Second (00 to 59), initial value is -1
PTN_START_DATE/PTN_START_TIME	Program operation stop date/time
YY	Year (00 to 99)
mo	Month (01 to 12)
dd	Day (01 to 31)
hh	Hour (00 to 23)
mi	Minute (00 to 59)
ss	Second (00 to 59), initial value is -1
_	Space

When a program pattern is not in execution, information about the last pattern that was executed at the time of termination is output. In this case, the remaining segment time (SEGTM) and the wait time of wait action (WAITTM) are zeroes.

7.2 Output Format of ASCII Data

Example

```
EA
PTNO 5
SEGNO 10
PRE_SEGNO 2
SEGUSE 7
SEGTM 11:05:22
WAITTM 00:06:00
RCYMOD 1
ALL_RCY 20
REM_RCY 2
RST 3
REN 6
PTN_START_DATE 02/01/03
PTN_START_TIME 10:00:00
PTN_STOP_DATE 02/01/05
PTN_STOP_TIME 10:00:00
EN
```

Output of PV Event/Time Event Information

- The FK command is used to output the data.
- When in program operation, the statuses of the current PV event and time event are output. When not in program operation, zeroes are output for the statuses of the PV event and time event.

Syntax

```
EACRLF
xxx . xxx . xxx . xxxCRLF
YYY . YYY . YYY . YYYCRLF
ENCRLF
```

- xxx
- The statuses of bits 31 to 24, 23 to 16, 15 to 8, and 7 to 0 are indicated in order in decimal notation.
 - The occurrence of PV events 1 to 16 is indicated by the status of bits 0 to 15. Thus, the upper two digits of xxx are zeroes.
0: Event not occurring, 1: Event occurring

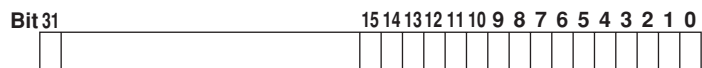

- YYY
- The statuses of bits 1 to 24, 23 to 16, 15 to 8, and 7 to 0 are indicated in order in decimal notation.
 - The occurrence of time events 1 to 16 is indicated by the status of bits 0 to 15. Thus, the upper two digits of xxx are zeroes.
0: Event not occurring, 1: Event occurring

Example

When PV event 1 and time events 2 and 3 are occurring.

```
EA
000.000.000.001
000.000.000.006
EN
```

Status of the Program Control End Signal

- The FV command is used to output the data.
- The program control end signal is turned “ON” for approximately 5 s after the program control terminates normally. It does not turn “ON” if the program is forcibly terminated (termination through resetting). You can assign the program control end signal to a contact output and have the contact turned “ON” for approximately 5 s after the program control terminates normally. You can use the FV command to output the status of the program control end signal.

Syntax

```
EACRLF
xCRLF
ENCRLF
```

x Status of the program control end signal (0 or 1)
 0: Program control end signal is “OFF”
 1: Program control end signal is “ON”

Example

```
EA
1
EN
```

Communication Log

- The FL command is used to output the data.
- A log of setting/basic setting/output commands and responses is output. Up to 200 logs are retained. Logs that exceed 200 are cleared from the oldest data.

Syntax

```
EACRLF
yy/mo/dd_hh:mi:ss_n_uuu...ufd_mmm...mCRLF
.....
ENCRLF
```

YY Year (00 to 99)
 mo Month (01 to 12)
 dd Day (01 to 31)
 hh Hour (00 to 23)
 mi Minute (00 to 59)
 ss Second (00 to 59)
 n Connection ID. A number used to identify the user that is connected.
 0: Serial
 1 to 3: Ethernet
 uuu...u User name (up to 16 characters)
 f Multiple command flag
 Space: Single
 *: Multiple
 (If multiple commands are separated by sub delimiters and output at once, “*” is displayed. The multiple commands are divided at each sub delimiter and stored as individual logs (1 log for 1 command and 1 log for 1 response.)
 d Input/Output
 >: Input
 <: Output

7.2 Output Format of ASCII Data

mmm . . . m Message (up to 20 characters)

- The communication log contains only the error number and not the error message section.
- Normally, the transfer data are transmitted as they are, but in some cases, a special message is output. The special messages are shown below.

Reception

(Over length): Command length exceeded.
(Over number): Number of commands exceeded
(Serial error): Received an error character through serial commuk Cations.

Transmission

(ddd byte): data output (ddd is the number of data points)
(Login): login
(Logout): logout
(Disconnected): Forced disconnection (occurs when the connection was disconnected when transmitting data using Ethernet)
(Time out) : Timeout, keepalive, TCP retransmission, etc.)
E1 nnn: Single negative response where nnn is the error number.
E2 ee:nnn: Multiple negative response where ee is the error position and nnn is the error number.

— Space

Example

The following example shows the log when multiple commands separated by sub delimiters, "B01; ???; CS1," are transmitted. The commands are separated and output in order with the multiple command flags "* ."

```
EA
99/05/11 12:31:11 1 user      * > B01
99/05/11 12:31:11 1 user      * < E0
99/05/11 12:31:11 1 user      * > ???
99/05/11 12:31:11 1 user      * < E2 01:124
99/05/11 12:31:11 1 user      * > CS1
99/05/11 12:31:11 1 user      * < E0
EN
```

FTP Log

- The FL command is used to output the data.
- The FTP client log is output. Up to 50 file transfer logs are retained. Logs that exceed 50 are cleared from the oldest data.
- For the meanings of the error codes, see the *user's manual IM 04L31A01-01E* or *IM 04L31A01-03E*.

Syntax

EACRLF

yy/mo/dd_hh:mi:ss_nnn_XXXXXXXX_k_ffffff_eeeCRLF

.....

ENCRLF

yy	Year (00 to 99)
mo	Month (01 to 12)
dd	Day (01 to 31)
hh	Hour (00 to 23)
mi	Minute (00 to 59)
ss	Second (00 to 59)
nnn	Error code (001 to 999)
XXXXXXXX	Detailed code (9 characters)
k	Server type (FTP destination)
	P: Primary
	S: Secondary
ffffff	File name (8 characters)
eee	Extension (3 characters)
-	Space

Example

```
EA
99/07/26 10:00:00          P 72610000 DDR
99/07/27 10:00:00          P 72710000 DDR
99/07/28 10:00:00 123 HOSTADDR P 72810000 DDR
99/07/29 10:00:00 123 HOSTADDR P 72910000 DDR
EN
```

Operation Error Log

- The FL command is used to output the data.
- The operation error log is output. Up to 50 operation error logs are retained. Logs that exceed 50 are cleared from the oldest data.
- Other communication messages (400 to 999) and status messages (500 to 599) are not output.
- For the meanings of the error codes, see the *user's manual IM 04L31A01-01E* or *IM 04L31A01-03E*.

Syntax

```
EACRLF
yy/mo/dd_hh:mi:ss_nnn_uuu...uCRLF
.....
ENCRLF
```

yy	Year (00 to 99)
mo	Month (01 to 12)
dd	Day (01 to 31)
hh	Hour (00 to 23)
mi	Minute (00 to 59)
ss	Second (00 to 59)
nnn	Error code (001 to 999)
uuu...u	Error message (up to 80 characters)
_	Space

Example

```
EA
99/05/11 12:20:00 212 "Format error."
99/05/11 12:30:00 217 "Unknown file type."
EN
```

Key Login Log

- The FL command is used to output the data.
- A log of users that have logged in and logged out is output. Up to 50 login/logout logs are retained. Logs that exceed 50 are cleared from the oldest data.
- If the power goes down while logged in, you will be logged out. In this case, however, it will not be recorded as a logout.
- User number and user name are not output at the time of the logout.

Syntax

```
EACRLF
yy/mo/dd_hh:mi:ss_xxx_nn_uuu...uCRLF
.....
ENCRLF
```

yy	Year (00 to 99)
mo	Month (01 to 12)
dd	Day (01 to 31)
hh	Hour (00 to 23)
mi	Minute (00 to 59)
ss	Second (00 to 59)
xxx	Login or logout (In_, Out) Left-justified
nn	User number (01 to 07)
uuu...u	User name (up to 16 characters)
_	Space

Example

```
EA
99/05/11 12:20:00 In 01 administrator
99/05/11 12:30:00 Out
99/05/11 12:20:00 In 03 user
99/05/11 12:30:00 Out
EN
```

Web Operation Log

- The FL command is used to output the data.
- The log of operations on the Web browser is output. Up to 50 operations are retained. Logs that exceed 50 are cleared from the oldest data.

Syntax

```
EACRLF
yy/mo/dd_hh:mi:ss_ffffff_eee_???...CRLF
.....
ENCRLF
```

yy Year (00 to 99)
mo Month (01 to 12)
dd Day (01 to 31)
hh Hour (00 to 23)
mi Minute (00 to 59)
ss Second (00 to 59)
ffffff Requested operation
 SCREEN: Screen change
 KEY: Key operation
 MSG: Message assignment/write
eee Error code when executing the requested operation
 All spaces: Success
 001 to 999: Error code
???... Parameter for each cause (see below)

- When fffffff = SCREEN

```
yy/mo/dd_hh:mi:ss_ffffff_eee_ddd_nnCRLF
ddd        Display type
TREND:     Trend display
DIGIT:     Digital display
BAR:       Bar graph display
CTRL:      Controller display
FACE:      Faceplate display
HYBRD:     Hybrid display
PRG:       Program control display
```
- When fffffff = KEY

```
yy/mo/dd_hh:mi:ss_ffffff_eee_kkkkkCRLF
kkkkk     Type of key that was operated
DISP:     DISP/ENTER key
UP:       Up key
DOWN:     Down key
LEFT:     Left key
RIGHT:    Right key
```

nn Group number (01 to 10)

7.2 Output Format of ASCII Data

- When `ffffff` = MSG
`yy/mo/dd_hh:mi:ss_ffffff_eee_nn_mmm...CRLF`
`nn` Message number (01 to 08)
`mmm...` Message (up to 16 characters)
`_` Space

Example

```
EA
01/02/11 12:20:00 SCREEN 275 TREND 01
01/02/11 12:21:00 SCREEN BAR 01
01/02/11 12:30:00 KEY UP
01/02/11 12:31:00 KEY RIGHT
01/02/11 12:40:00 MSG 05 Hello-Hello
01/02/11 12:41:00 MSG 05 Hello-Hello
EN
```

E-mail Log

- The FL command is used to output the data.
- The e-mail transmission log is output. Up to 50 operations are retained. Logs that exceed 50 are cleared from the oldest data.

Syntax

```
EACRLF
yy/mo/dd_hh:mi:ss_ffffff_eee_n_uuu...CRLF
.....
ENCRLF

YY      Year (00 to 99)
mo      Month (01 to 12)
dd      Day (01 to 31)
hh      Hour (00 to 23)
mi      Minute (00 to 59)
ss      Second (00 to 59)
ffffff  Reason
        ALARM: Alarm mail
        TIME: Scheduled mail
        REPORT: Report timeup mail
        FAIL: Power failure recovery mail
        FULL: Memory full mail
        TEST: Test mail
        ERROR: Error message mail
eee     Error code
        All spaces: Success
        001to 999: Error code
n       Recipient list
        1: List 1
        2: List 2
        +: List 1 and list 2
uuu...  Array of recipient e-mail addresses (up to 30 characters)
_       Space
```

Example

```
EA
01/05/11 12:20:00 ALARM + notice
01/05/11 12:30:00 REPORT 375 1 user1 user2
EN
```

Alarm Summary

- The FL command is used to output the data.
- The alarm summary is output. Up to 120 alarm information sets are retained. Alarm information sets that exceed 120 are cleared from the oldest data.

Syntax

EACRLF

yy/mo/dd_hh:mi:ss_kcc_ls_YY/MO/DD_HH:MI:SSCRLF

.....

ENCRLF

yy/mo/dd hh:mi:ss	Time when the alarm occurred
YY	Year (00 to 99)
mo	Month (01 to 12)
dd	Day (01 to 31)
hh	Hour (01 to 23)
mi	Minute (01 to 59)
ss	Second (01 to 59)
ccc	Channel number
	0xx: Measurement channel (001 to 020) (001 to 006 on the CX1000)
	Axx: Computation channel (A31 to A60) (A31 to A42 on the CX1000)
	1xx: Internal control channel (101 to 118) (101 to 106 on the CX1000)
	2xx: External control channel (201 to 248) (201 to 212 on the CX1000)
l	Alarm level (1 to 4)
sss	Alarm type (H, h, L, l, R, r, T, t, PVH, PVL, DVH, DVL, DVD, DVI, SPH, SPL, OTH, OTL, ETC, space) For the meaning of each symbol, see "Measured/Computed/Control Data" in this section.
YY/MO/DD HH:MI:SS	Alarm release time (alarm release time is not output if the alarm has not been released)
YY	Year (00 to 99)
MO	Month (01 to 12)
DD	Day (01 to 31)
HH	Hour (01 to 23)
MI	Minute (01 to 59)
SS	Second (01 to 59)
-	Space

Example

EA

01/05/11 12:20:00 001 1L 01/05/11 12:25:00

01/05/11 12:30:00 A31 3t

EN

Message Summary

- The FL command is used to output the data.
- The message summary is output. Up to 100 messages are retained. Messages that exceed 100 are cleared from the oldest log.

Syntax

```
EACRLF
yy/mo/dd_hh:mi:ss_nn_mmm..._uuu...CRLF
.....
ENCRLF
```

yy	Year (00 to 99)
mo	Month (01 to 12)
dd	Day (01 to 31)
hh	Hour (01 to 23)
mi	Minute (01 to 59)
ss	Second (01 to 59)
nn	Message number (01 to 08)
mmm...	File name (16 characters. Spaces are appended when the number of characters is less than 16 characters.)
uuu...	User name (up to 16 characters. Output only when the key login function is used.)
_	Space

Example

```
EA
01/05/11 12:20:00 01 hello-hello superstar
01/05/11 12:20:00 03 0123456789abcdef kokoko
EN
```

Status Information

- The IS command is used to output the data.
- The operation status of the CX is output
- For details on the status information, see section 8.2, “The Bit Structure of the Status Information.”

Syntax

```
EACRLF
ddd.ccc.bbb.aaaCRLF
ENCRLF
```

aaa	Status information 1 (000 to 255)
bbb	Status information 2 (000 to 255)
ccc	Status information 3 (000 to 255)
ddd	Status information 4 (000 to 255)

Example

```
EA
000.000.032.000
EN
```

File List

- The ME command is used to output the data.
- The file list and the file data sizes of the specified directory on the CX's external storage medium are output.

Syntax

```
EACRLF
fffffff_eee_ssssssss_yy/mo/dd_hh:mi:ss_1111111111CRLF
.....
zzzzzzz Kbyte freeCRLF
ENCRLF
```

fffffff File name (8 characters)
If this is a directory, the characters <DIR> is shown at the position displaying the file data size.

eee Extension (3 characters)

ssssssss Data size of the file (_____0 to 99999999) [byte(s)]

yy Year (00 to 99)

mo Month (01 to 12)

dd Day (01 to 31)

hh Hour (00 to 23)

mi Minute (00 to 59)

ss Second (00 to 59)

zzzzzzz Free space on the medium (_____0 to 99999999)

1111111111 ID number (_____0 to 9999999999)

- The output is numerical value only when the file extension is CEV or CDS. This value is specific to the file and is the same as the ID number of the block in the internal memory from which the file originates.
 - The output is a space when the file extension is not CEV or CDS.
 - The output is a "0" if the file was saved using another instrument (CX).
- Space

Example

```
EA
XV1      CEV      124 99/02/24 20:07:12      12310
XV1      PCL      1204 99/01/19 01:52:37
DATA     <DIR>    99/01/19 01:23:64
        523 Kbyte free
EN
```

Data List

- The MI/MO command is used to output the data.
- The number of blocks and file names of the specified data in the internal memory are output.
- If the first parameter of the MI/MO command is DIR, the data in the internal memory is put on standby and the list is output.

Syntax

```
EACRLF
aaCRLF
bb_ffffff_eee_sssss_yy/mo/dd_hh:mi:ssk111111111111CRLF
.....
ENCRLF
```

aa	Number of valid blocks (00 to 99)
bb	Block number (00 to 99)
ffffff	File name (8 characters)
eee	Extension (3 characters)
sssss	Number of collections (_____1 to 999999)
yy	Year (00 to 99)
mo	Month (01 to 12)
dd	Day (01 to 31)
hh	Hour (00 to 23)
mi	Minute (00 to 59)
ss	Second (00 to 59)

The year/month/day/hour/minute/second will contain the time when the last data of the block were acquired.

k	Data attributes
	* Internal memory block being sampled
	+ Internal memory block being overwritten
	Space Fixed block

If the data of the original block are changing when the data is put on standby, * or + is output.

1111111111	ID number (_____0 to 9999999999)
------------	----------------------------------

- The output is numerical value only when the file extension is CEV or CDS. This value is specific to the data.
- The output is a space when the file extension is not CEV or CDS.

Space

Example

```
EA
02
01 DATA0001 DHR 128 99/02/24 20:10:00
02 DATA0002 DDR 128 99/02/24 20:11:00
EN
```

User Level

- The FU command is used to output the data.
- User name, user level, and other information are output.

Syntax

EACRLF

p_l_uuu...uCRLF

ENCRLF

<i>p</i>	Physical layer E: Ethernet S: RS-232 or RS-422/485
<i>l</i>	User level A: ADMINISTRATOR U: USER
<i>uuu...u</i>	User name (up to 16 characters)
<i>-</i>	Space

Example

EA

E A admin

EN

7.3 Output Format of BINARY Data

This section describes the output format of the BINARY data that is disclosed. For information on other BINARY data, see “Identifier” on page 7-3.

- Measured/computed/control data and FIFO data.
- Display data
- Event data

The measured/computed data is output using signed 16-bit integer; the computed data is output using signed 32-bit integer. Physical value is derived adding the decimal point and unit. The decimal point position can be determined using the FE command.

Example of Deriving Physical Values from Binary Data

BINARY Data	Decimal Point Position	Physical Value (Measured Value)
10000	0	10000
10000	1	1000.0
10000	2	100.00
10000	3	10.000
10000	4	1.0000

Note

The “CRLF” used in this section denotes carriage return line feed.

Measured/Computed/Control Data and FIFO Data

- The FD command is used to output the measured/computed/control data.
- The FF command is used to output the FIFO data.
- The ID number of the output format is “1.” See “Identifier” on page 7-3.

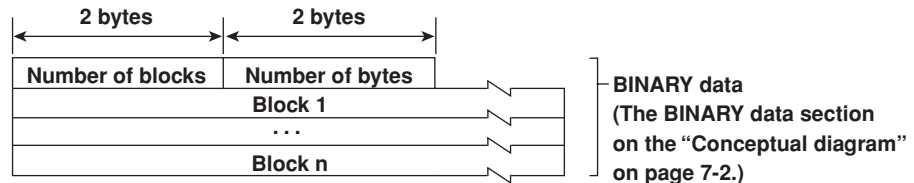

Number of Blocks

This is the number of blocks.

Number of Bytes

This is the size of one block in bytes.

Block

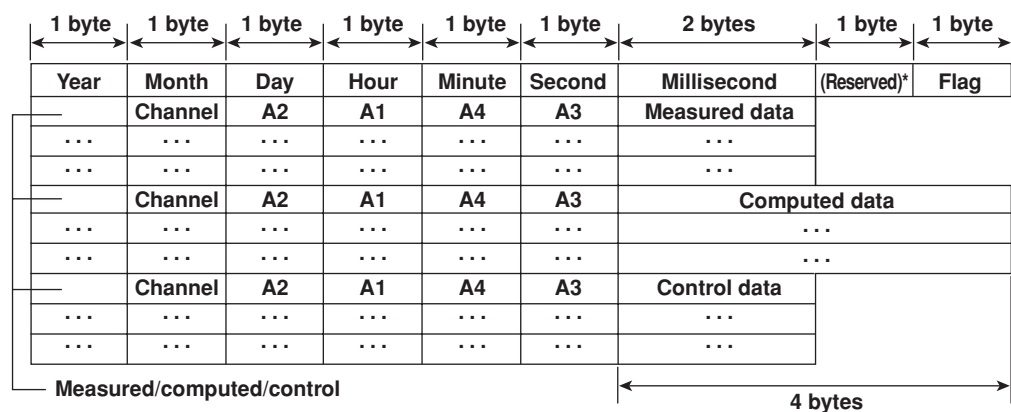

* The sections indicated as (Reserved) are not used. The value is undefined.

- **Flag**

The meaning of the flags are given on the table below. The flags are valid during FIFO data output. The flags are undefined for other cases.

Bit	Flag		Meaning of the Flag
	0	1	
7	No	Yes	Indicates that the screen snap shot was executed.
6	–	–	
5	–	–	
4	–	–	
3	–	–	
2	No	Yes	Indicates that the decimal position or unit information was changed during measurement.
1	No	Yes	Indicates that the FIFO acquiring interval was changed with the FR command during measurement.
0	No	Yes	Indicates that the internal process took too much time (computation, for example) and that the measurement could not keep up at the specified scan interval.

The bits that have “–” for the flag are not used. The value is undefined.

- **Block Member**

Name	BINARY Value
Year	0 to 99
Month	1 to 12
Day	1 to 31
Hour	0 to 23
Minute	0 to 59
Second	0 to 59
Millisecond	0 to 999
(Reserved)	Undefined
Measurement/computation/control Channel	00H: measurement/control, 80H: computation 01 to 248
Alarm status*	
A1	
A2	0 to 31
A3	
A4	

* BINARY value 0 to 31 is entered using a byte for the alarm status. The binary values 0 to 31 correspond to the alarm types of H (high limit alarm), L (low limit alarm), h (difference high-limit alarm), l (difference low-limit alarm), R (high limit on rate-of-change alarm), r (low limit on rate-of-change alarm), T (delay high limit alarm), t (delay low limit alarm), PVH (PV high-limit alarm), PVL (PV low-limit alarm), DVH (deviation high-limit alarm), DVL (deviation low-limit alarm), DVO (deviation high & low limit alarm), DVI (deviation within high & low limits alarm), SPH (SP high-limit alarm), SPL (SP low-limit alarm), OTH (output high-limit alarm), OTL (output low-limit alarm), ETC (other alarm), and space (no alarm) as follows:
0: no alarm, 1: H, 2: L, 3: h, 4: l, 5: R, 6: r, 7: T, 8: t, 21: PVH, 22: PVL, 23: DVH, 24: DVL, 25: DVO, 26: DVI, 27: SPH, 28: SPL, 29: OTH, 30: OTL, 31: ETC.

Special Data Values

The measured/computed/control data take on the following values under special conditions.

Special Data Value Type	Measured/Control data	Computed data
+ Over	7FFFH	7FFF7FFFH
– Over	8001H	80018001H
Skip	8002H	80028002H
Error	8004H	80048004H
Undefined	8005H	80058005H

Note

The number of blocks, number of bytes, and measured/computed/control data are output according to the byte order specified with the BO command.

Display Data

- The MI command is used to output the FIFO data.
- The ID number of the output format is “11.” See “Identifier” on page 7-3.

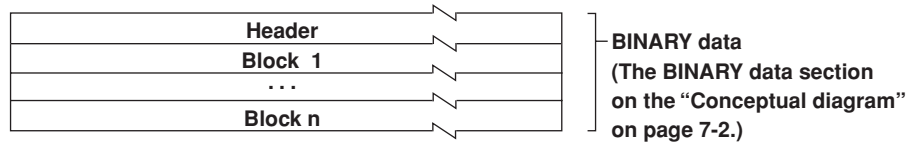

Header

Syntax

```

aaaaaa,ddd,ffffggg,ttttttCRLF
DATE_yy/mo/ddCRLF
TIME_hh:mi:ss.mmmtCRLF
s_kccuuuuuu,ppCRLF
.....
s_kccuuuuuu,ppCRLF
    
```

aaaaaa	Number of blocks (6 digits) Matches the number of blocks, n, in the above figure.
ddd	Number of channels (3 digits)
ffff	Sampling interval value (4 digits)
ggg	Sampling interval unit (3 characters, left justified)
tttttt	Data number of the trigger position (6 digits, counting starts with 0.) For display data, this value is the number of the last display data.
yy	Year (00 to 99)
mo	Month (01 to 12)
dd	Day (01 to 31)
hh	Hour (00 to 23)
mi	Minute (00 to 59)
ss	Second (00 to 59)
mmm	Millisecond (000 to 999)
t	Reserved (Space.)
s	Data status N: Normal D: Differential input
ccc	Channel number 0xx: Measurement channel (001 to 020) (001 to 006 on the CX1000) Axx: Computation channel (A31 to A60) (A31 to A42 on the CX1000) 1xx: Internal control channel (101 to 118) (101 to 106 on the CX1000) 2xx: External control channel (201 to 248) (201 to 212 on the CX1000)
uuuuuu	Unit information (6 characters, left-justified) mV____: mV V____: V ^C____: °C xxxxxx: (User-defined character string)
pp	Decimal point position (00 to 04) No decimal point (00000) for 00. One digit to the right of the decimal (0000.0) for 01. Two digits to the right of the decimal (000.00) for 02. Three digits to the right of the decimal (00.000) for 03. Four digits to the right of the decimal (0.0000) for 04.
_	Space

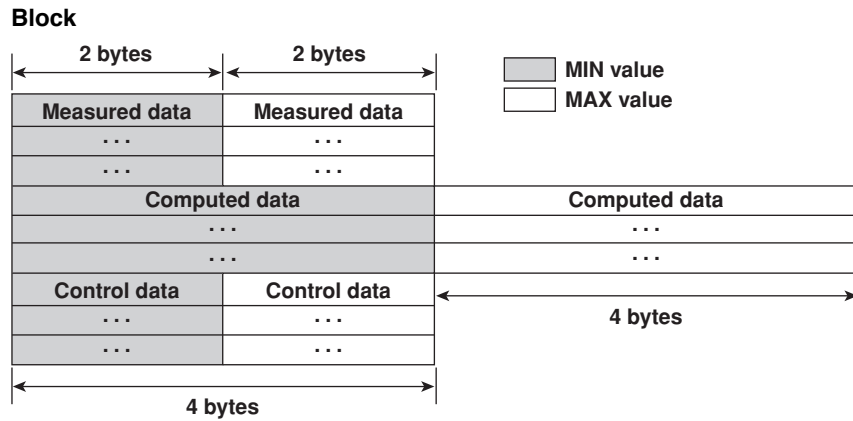

Special Data Values

The measured/computed/control data take on the following values under special conditions.

Special Data Value Type	Measured/Control Data	Computed Data
+ Over	7FFFH	7FFF7FFFH
- Over	8001H	80018001H
Skip	8002H	80028002H
Error	8004H	80048004H
Undefined	8005H	80058005H

Note

The measured/computed/control data is output according to the byte order specified with the BO command.

Event Data

- The MI command is used to output the FIFO data.
- The ID number of the output format is “12.” See “Identifier” on page 7-3.

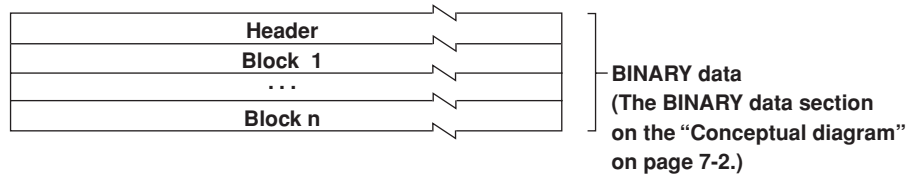

Header

Same as the “Header” for the display data.

Block

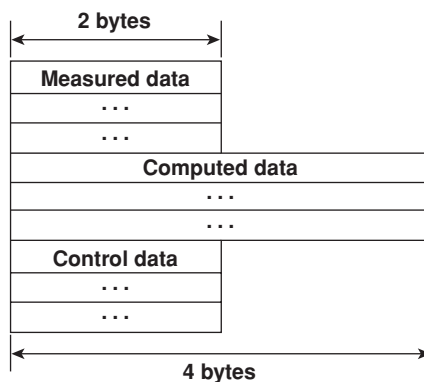

Special Data Values

The measured/computed/control data take on the following values under special conditions.

Special Data Value Type	Measured/Control Data	Computed Data
+ Over	7FFFH	7FFF7FFFH
– Over	8001H	80018001H
Skip	8002H	80028002H
Error	8004H	80048004H
Undefined	8005H	80058005H

Note

The measured/computed/control data is output according to the byte order specified with the BO command.

Manual Sampled Data

- The ME or MO command is used to output the data.
- The ID number of the output format is “4.” See “Identifier” on page 7-3.
- For a description of the data format, see the *user’s manual IM 04L31A01-01E* or *IM 04L31A01-03E*.

Report Data (Hourly, Daily, Weekly, and Monthly)

- The ME or MO command is used to output the data.
- The ID number of the output format is “5” for the hourly data, “6” for the daily data, “7” for the weekly data, and “8” for the monthly data. See “Identifier” on page 7-3.
- For a description of the data format, see the *user’s manual IM 04L31A01-01E* or *IM 04L31A01-03E*.

DI/DO Data and Internal Switch Status (Style Number S3 Or Later)

- DI/DO data and the internal switch status can be output using an FN command.
- The output format identifier is 1. See page 7-3, "Identifier."

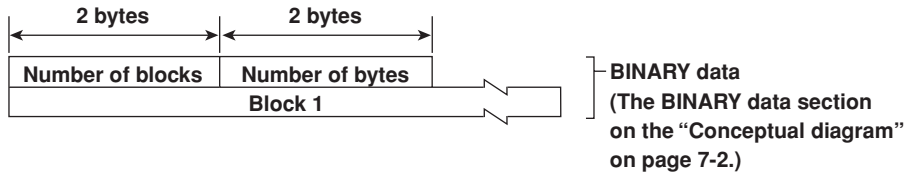

Number of Blocks

This is the number of blocks (fixed at 0.)

Number of Bytes

This is the size of one block in bytes.

Block

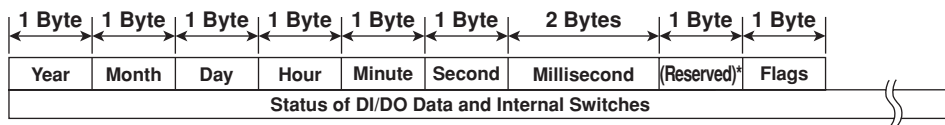

Status of DI/DO data and internal switches

CX2000

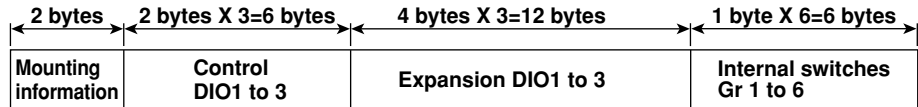

CX1000

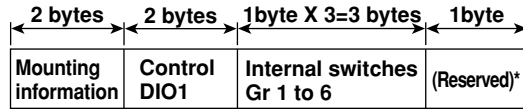

* The sections indicated as (Reserved) are not used. The value is fixed to "0."

Data details

Mounting information (2 bytes)

- bit0: control module 1 Mounted (1), not Mounted (0)
- bit1: control module 2 Mounted (1), not Mounted (0)
- bit2: control module 3 Mounted (1), not Mounted (0)
- bit3: 0
- bit4: expansion module 1 Mounted (1), not Mounted (0)
- bit5: 0
- bit6: 0
- bit7-bit 15: 0

Control DIO1-3 (2 bytes)

- bit0: DI 0 (1:ON, 0:OFF)
- bit1: DI 1 (1:ON, 0:OFF)
- :
- bit5: DI 6 (1:ON, 0:OFF)
- bit6-bit7: 0
- bit8: DO 0 (1:ON, 0:OFF)
- bit9: DO 1 (1:ON, 0:OFF)
- :
- bit13: DO 6 (1:ON, 0:OFF)

7.3 Output Format of BINARY Data

Expansion DI01–3 (4 bytes)

bit0: DI 0 (1:ON, 0:OFF)
 bit1: DI 1 (1:ON, 0:OFF)
 :
 bit11: DI 11 (1:ON, 0:OFF)
 bit12–bit 15:0
 bit16: DO 0 (1:ON, 0:OFF)
 bit17: DO 1 (1:ON, 0:OFF)
 :
 bit27: DO 11 (1:ON, 0:OFF)
 bit28–bit 31:0
 Expansion DI02 and expansion DI03 are all 0

Internal Switches (Groups 1–6, 1 Byte)

bit0: SW001 (1:ON, 0:OFF)
 bit1: SW002 (1:ON, 0:OFF)
 :
 bit5: SW006 (1:ON, 0:OFF)
 bit6, bit7:0
 Divide up internal switches into groups of 6

Status (Active/Inactive) of DIO Operation Monitoring Function Operation Mode (Style Number 3 or Later)

- The status of DI/DO operation monitoring function is output using an FO command.
- The output format identifier is 1. See page 7-3, “Identifier.”

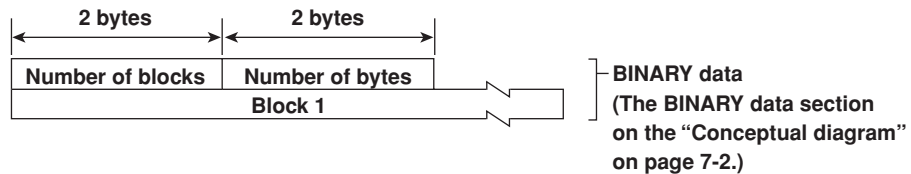

Number of Blocks

This is the number of blocks (fixed at 0.)

Number of Bytes

This is the size of one block in bytes.

Blocks

CX2000

1 byte	1 byte	1 byte	1 byte	1 byte	1 byte	Status (Active/Inactive) of DIO operation monitoring function
DIO1-6	DIO7-12	DIO13-18	DIO19-24	DIO25-30	DIO31-36	
DIO1	DIO2	DIO3	DIO4	DIO5	DIO6	DIO type
DIO7	DIO8	DIO9	DIO10	DIO11	DIO12	DIO type
DIO13	DIO14	DIO15	DIO16	DIO17	DIO18	DIO type
DIO19	DIO20	DIO21	DIO22	DIO23	DIO24	DIO type
DIO25	DIO26	DIO27	DIO28	DIO29	DIO30	DIO type
DIO31	DIO32	DIO33	DIO34	DIO35	DIO36	DIO type
DIO1-6	DIO7-12	DIO13-18	DIO19-24	DIO25-30	DIO31-36	Operation setting of DIO operation monitoring function
DIO1-6	DIO7-12	DIO13-18	DIO19-24	DIO25-30	DIO31-36	Status of DIO operation monitoring function input
DIO1-6	DIO7-12	DIO13-18	DIO19-24	DIO25-30	DIO31-36	Status of DIO operation monitoring function output

CX1000

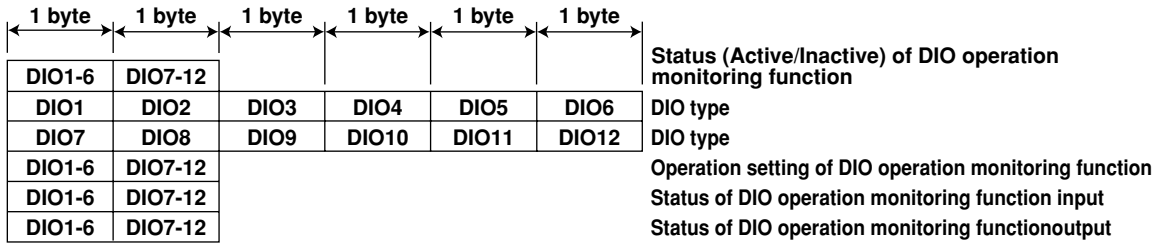

Data details

DIO operation monitoring function setting status

DIO-1-6 (1 byte)

bit0: DIO operation monitoring function status setting of DIO operation monitoring 1 (1: active, 0: inactive)

bit1: DIO operation monitoring function status setting of DIO operation monitoring 2 (1: active, 0: inactive)

:

bit5: DIO operation monitoring function status setting of DIO operation monitoring 6 (1: active, 0: inactive)

bit6-bit7: 0

Shows whether the DIO operation monitoring setting for each DIO operation monitoring number is active. Assigns the active/inactive DIO operation monitoring setting to bits 0 through 5 from the smallest DIO monitoring number to the largest for other bytes as well.

DIO type setting

DI01 (1 byte), the DIO type for DI01

0: DI-1 (default setting), 1:DO-1,2: DO-2,3: DIO-12,4: DIO12,5: DO-2P,6: DIO-12P

Outputs the DIO type for DI01-DIO36 (or DIO12 for the CX1000)

Operation Setting for DIO Operation Monitoring

DI01-6 (1 byte)

bit0: Auto/manual status of DIO operation monitoring 1 (0: manual, 1: automatic).

bit1: Auto/manual status of DIO operation monitoring 2 (0: manual, 1: automatic).

:

bit5: Auto/manual status of DIO operation monitoring 6 (0: manual, 1: automatic).

bit6-bit7: 0

Shows the auto/manual status of DIO operation monitoring for each DIO operation monitoring number. Assigns the auto/manual DIO operation monitoring status to bits 0 through 5 from the smallest DIO monitoring number to the largest for other bytes as well. Sets auto/manual status of inactive DIO operation monitoring items to 0.

7.3 Output Format of BINARY Data

Input Status of DIO Operation Monitoring

DI01–6 (1 byte)

bit0: Input status of DIO operation monitoring 1 (0: OFF, 1: ON).

bit1: Input status of DIO operation monitoring 2 (0: OFF, 1: ON).

:

bit5: Input status of DIO operation monitoring 6 (0: OFF, 1: ON).

bit6–bit7: 0

Shows the input status of DIO operation monitoring for each DIO operation monitoring number. Assigns the input status of DIO operation monitoring to bits 0 through 5 from the smallest DIO monitoring number to the largest for other bytes as well. The output status for DIO types not set to DI is indefinite whether or not DIO operation monitoring is active.

Output status of DIO operation monitoring

DI01–6 (1 byte)

bit0: Output status of DIO operation monitoring 1 (0: OFF, 1: ON).

bit1: Output status of DIO operation monitoring 2 (0: OFF, 1: ON).

:

bit5: Output status of DIO operation monitoring 6 (0: OFF, 1: ON).

bit6–bit7: 0

Shows the output status of DIO operation monitoring for each DIO operation monitoring number. Assigns the output status of DIO operation monitoring to bits 0 through 5 from the smallest DIO monitoring number to the largest for other bytes as well. The output status for DIO types not set to DO is indefinite whether or not DIO operation monitoring is active.

Number and Operation Status of the Currently Running Program Patterns (Style Number 3 or Later)

- The number, operation status, and loop numbers assigned to the currently running pattern can be output using an FW command.
- The output format identifier is 1. See page 7-3, "Identifier."
- The information for patterns whose operation status is 0 (RESET) is past information.

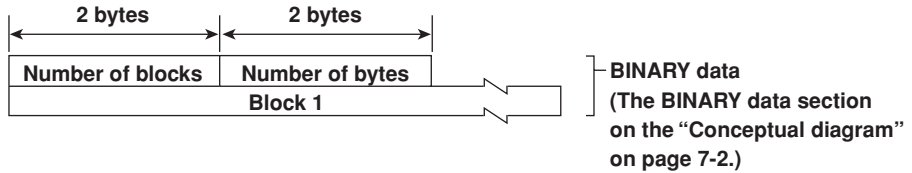

Number of Blocks

This is the number of blocks (fixed at 0.)

Number of Bytes

This is the size of one block in bytes.

Blocks

CX2000

1 byte	1 byte	1 byte	1 byte	1 byte	1 byte	1 byte	2 bytes	1 byte	1 byte
Year	Month	Day	Hour	Minute	Second	Millisecond	(Reserved)*	Flag	
Pattern No	Operaton status	Loop information	} 6 patterns worth of information						

CX1000

1 byte	1 byte	1 byte	1 byte	1 byte	1 byte	1 byte	2 bytes	1 byte	1 byte
Year	Month	Day	Hour	Minute	Second	Millisecond	(Reserved)*	Flag	
Pattern No	Operaton status	Loop information	} 2 patterns worth of information						

Data details

Pattern Number

1–30 running pattern numbers for RUN status, or indefinite for RESET status.

Operation status

bit0: RUN/RESET status (1:RUN, 0: RESET)

bit1: HOLD status (1: holding, 0: not holding), however, RESET is 0

bit2: WAIT status (1: waiting, 0: not waiting), however, RESET is 0

bit3–bit7: 0

Loop Information Assigned to Patterns in RUN Status (Indefinite upon RESET)

CX2000

bit0: Loop 1 (1:assigned, 0: unassigned)

bit1: Loop 2 (1:assigned, 0: unassigned)

:

bit5: Loop 6 (1:assigned, 0: unassigned)

bit6–bit7: 0

7.3 Output Format of BINARY Data

CX1000
 bit0: Loop 1 (1:assigned, 0: unassigned)
 bit1: Loop 2 (1:assigned, 0: unassigned)
 bit2-bit7: 0

Measurement/Computation/Control Channel Alarm Types, Output of Settings (Style Number S3 or Later)

- Measurement/computation/control channel alarm types, and settings are output using the FS command.
- The output format identifier is 1. See page 7-3, "Identifier."

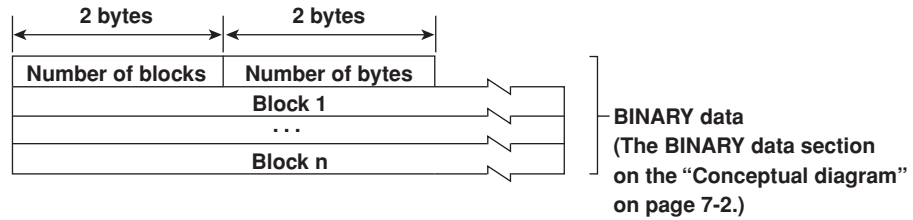

Number of Blocks

This is the number of blocks.

Number of Bytes

This is the size of one block in bytes.

Blocks

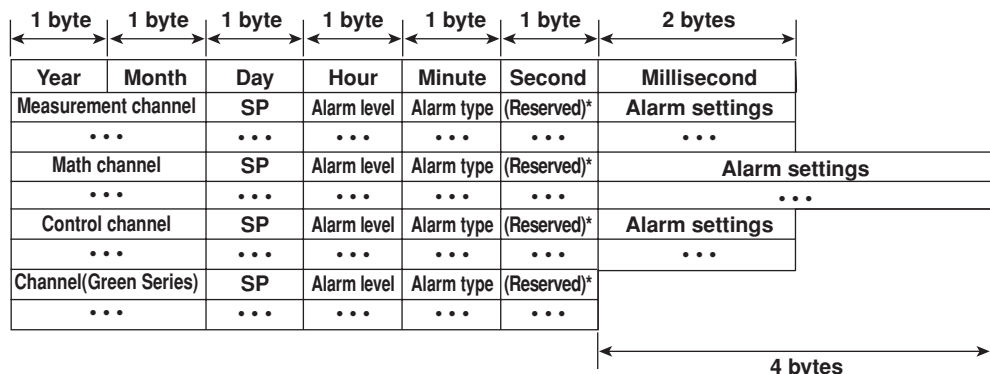

* The sections indicated as (Reserved) are not used. The value is fixed to "0."

Data details

Channel number

CX2000:1-20, 31-60, 101-118, 201-248

CX1000:1-3, 31-48, 101-106, 201-212

SP

Target setpoint number (0 for other than control channels)1-8

The top bit of the currently used target setpoint number data is 1.

Alarm level

0-3

Alarm type

0-31

For the correspondence between the alarm type and number, see the alarm status of "Measured/Computed/Control Data, and FIFO Data" on page 7-27.

Alarm settings

0 when the alarm type is 0 (no alarm). Not output on external temperature meter channels.

Note

- Information for skipped measurement channels, computation channels when computation is turned OFF, and control channels when control is turned OFF is not output.
- Alarm setting values for control channels set by loops are output as alarm information for the PV, SP, and OUT channels corresponding to the alarm types.
- When alarms are OFF, 0 is output for the alarm setting.
- If the alarm type is 0 in the control groups (control alarm OFF), an alarm value of 0 is output as alarm information for the PV channels.
- Information for channels belonging to loops set for analog retransmission are not output.

Output of Upper/Lower Limit of Input Span and Decimal Point Position for Measurement/Computation/Control Channels (Style number S3 or later)

- Upper/lower limit of input span and decimal place for measurement/computation/control channels are output using the FT command.
- The output format identifier is 1. See page 7-3, "Identifier."

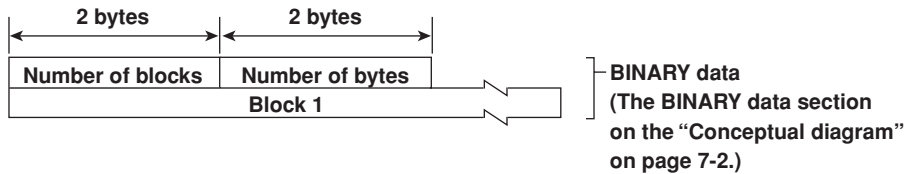

Number of Blocks

This is the number of blocks (fixed at 0.)

Number of Bytes

This is the size of one block in bytes.

Blocks

1 byte	1 byte	1 byte	1 byte	1 byte	1 byte	2 bytes
Year	Month	Month	Hour	Minute	Second	Millisecond
Measurement channel	(Reserved)*	Decimal P. P	Span(Lower limmit)	Span(Upper limmit)		
...
Computation channel	(Reserved)*	Decimal P. P	Span(Lower limmit)		Span(Upper limmit)	
...
Control channel	(Reserved)*	Decimal P. P	Span(Lower limmit)	Span(Upper limmit)		
...
Channel(Green Series)	(Reserved)*	Decimal P. P	Span(Lower limmit)	Span(Upper limmit)		
...

Decimal P. P: Decimal point position

2 bytes (under Span(Lower limmit) and Span(Upper limmit) for Measurement channel)

4 bytes (under Span(Upper limmit) for Computation channel)

Data details

Channel Numbers

CX2000:1-20, 31-60, 101-118, 201-248

CX1000:1-3, 31-48, 101-106, 201-212

Unused Region

Fixed at 0

7.3 Output Format of BINARY Data

Decimal point position

The decimal point position of each channel's input span

Lower limit of span

The lower limit value of each channel's input span

Upper limit of span

The upper limit value of each channel's input span

Note

- Information for skipped channels, or channels when control is turned OFF is not output.
 - For channels belonging to loops set for analog retransmission, only information for OUT channels is output. PV/SP channel information is not output.
-

7.4 Output Format of Instrument Information

This section describes the instrument information output format of the instrument information server.

Note

The “*CRLF*” used in this section denotes carriage return line feed.

Response

The parameters of the packet that are returned as a response are lined up according to the following format.

```

EACRLF
(Parameter 1) _=(value of parameter 1) CRLF
(Parameter 2) _=(value of parameter 2) CRLF
.....
ENCRLF
    
```

- The parameter values are output in the order specified by the command parameter.
- The output order of the parameters when “all” is specified is not constant.
- Even if the same parameters are specified numerous times, only the first occurrence is output.
- Lower-case characters are used for the parameters.
- “_” indicates a space.

The following table shows the parameter types.

Parameter	Output Information
all	All information that are output using the parameters (serial, model, host, ip) below
serial	Serial number
model	Manufacturer, model, and firmware version
host	Host name
ip	IP address

Output Example

Several output examples are indicated below.

Packet Parameter Sent as Commands	Response
The “all” parameter can be used to output all information for parameters serial, model, host, and ip. all	EA serial = 12V636848 model = YOKOGAWA,CX2000,1.01 host = CX2000-1 ip = 192.168.111.24 EN
Parameters are not case sensitive. ip HoSt	EA ip = 192.168.111.24 host = CX2000-1 EN
Even if the same parameters are specified numerous times, only the first occurrence is output. host ip host ip host model	EA host = CX2000-1 ip = 192.168.111.24 model = YOKOGAWA,CX2000,1.01 EN
Undefined parameters will be ignored. (Space)	EA EN

8.1 Status Information and Filter

The following figure depicts the status information and filter on the CX.

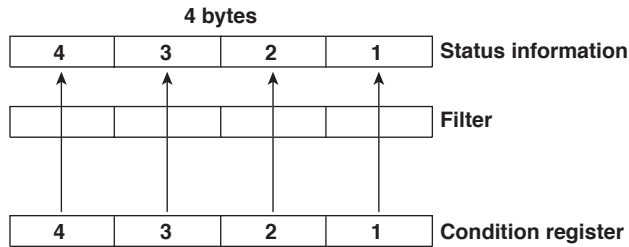

- The IF command can be used to set the filter.
- When a status indicated on the following page is entered, the corresponding bit in the condition register is set to "1." The logical AND of the condition register and the filter becomes the status information.
- The IS command is used to output the status information. Status information 1 and 2 are cleared when they are output. Status information 3 and 4 are not cleared when they are output; they remain at "1" while the event is occurring.
- When multiple connections are up, filters can be specified for the individual connection. Therefore, the status information can be held for each connection.

8.2 Bit Structure of the Status Information

The following four groups of status information are output in response to a status information output request using the IS command. For a description of the output format, see "Status Information" in section 7.2, "Output Format of ASCII Data."

Status Information 1

Bit	Name	Description
0	A/D conversion complete	Set to "1" when the A/D conversion of the measurement is complete.
1	Medium access complete	Set to "1" when the display, event, manual sampled, report, TLOG, or screen image data file are finished being saved to the external storage medium. Set to "1" when setting data is successfully saved or loaded.
2	Report generation complete	Set to "1" when report generation is complete.
3	Timeout	Set to "1" when the timer expires.
4	–	–
5	–	–
6	–	–
7	–	–

Status Information 2

Bit	Name	Description
0	Measurement dropout	Set to "1" when the measurement process of the measurement channel could not keep up.
1	Decimal point/unit information change	Set to "1" when the decimal point/unit information has been changed.*
2	Command error	Set to "1" when there is a command syntax error.
3	Execution error	Set to "1" when an error occurs during command execution.
4	–	–
5	–	–
6	–	–
7	–	–

* Set to "1" if there is a change in the measurement/computation/control channel.

Status Information 3

Bit	Name	Description
0	–	–
1	–	–
2	Memory end	Set to "1" while the free space in the internal memory or external storage medium is low (see section 1.19 in the <i>user's manual IM 04L31A01-01E</i> or <i>IM 04L31A01-03E</i>).
3	–	–
4	–	–
5	–	–
6	–	–
7	–	–

Status Information 4

Bit	Name	Description
0	Basic setting	Set to "1" during basic setting mode.
1	Memory sampling	Set to "1" while data are being acquired into the internal memory.
2	Computing	Set to "1" while computation is in progress.
3	Alarm occurring	Set to "1" while alarm is occurring.
4	Accessing medium	Set to "1" while the display, event, manual sampled, report, TLOG, or screen image data file are being saved to the external storage medium.
5	E-mail started	Set to "1" while the e-mail transmission is started.
6	Controlling	Set to "1" while executing control operation.
7	–	–

9.1 Specifications of the Green Series Communication Function

Communication Protocol

MODBUS communication RTU mode

Connecting Model (Controller)

- UT Series (UT320, UT321, UT350, UT351, UT420, UT450, UT520, UT550, and UT750 are applicable. However, if using “heating/cooling control” or “custom computation control” on the UT series, “ETC” is set on the selection menu.)
- Devices other than above that have the MODBUS slave function (selection menu shows “ETC” for these devices.)

Supported functions vary depending on the model.

Number of Connectable Loops

16 loops (4 loops on the CX1000)

Read Cycle

- Same as the read cycle of the Modbus master function.
- If you are using the UT series indicated above, a read cycle of 1 s is recommended for every 4 loops connected. However, communications with the UT320, UT321, UT350, and UT351 takes twice the amount of time as with other UT series instruments, therefore a read cycle of 2 s is recommended when using the UT320, UT321, UT350, or UT351 with 4 loops connected.

Function

Supported functions vary depending on the connecting model.

• When the connecting model is UT Series

1. Monitor and record PV, SP, and OUT values on the measurement display (such as the trend display).
2. Monitor the PV, SP, and OUT values on the control group display and control overview display.
3. Monitor the control operation (AUT/MAN/CAS, LOCAL/REMOTE, RUN/STOP, and alarm status) on the control group display or control overview display.
4. Monitor and record alarm information using the alarm summary function.
5. Monitor and record the control operation (AUT/MAN/CAS, LOCAL/REMOTE, and RUN/STOP) using the control summary function.
6. Monitor and change the PID parameters of each loop on the tuning display.
7. Change the SP value.
8. Change the OUT value in manual mode.
9. Switch AUTO/MAN.
10. Switch RUN/STOP.
11. Switch LOCAL/REMOTE.
12. Execute auto tuning.
13. Switch the SP number.
14. Automatic retrieval of various setup information of the controller
 CX2000: Auto reading possible on the External loop setting (Basic setting) display that appears by selecting “Basic Setting mode > [#10] (Control) > [#6] (External loop setting) > [#1] (Basic setting)”.
 CX1000: Auto reading possible on the Basic setting display that appears by selecting “Basic Setting mode > [#12] (Control) > [#8] (External loop setting) > [#1] (Basic setting)”.

• When the connecting model is “ETC”

Supports only the functions of 1, 2, and 5 above.

Various Setting Displays for the Green Series Communication Function

Parameters can be entered on various displays including External loop setting (Basic setting), External loop setting (Parameter address setting), and External loop setting (Tuning setting) displays. For details on each display, see the following sections.

External Loop Setting (Basic Setting) Display

- **When the connecting model is UT Series**
 - Various setup information can be automatically read from the connected device. If you specify the [Modbus address] on the External loop setting (Basic setting) display and execute [Auto reading], the CX, which is set to be the Modbus master, reads the following setup information from the connected device automatically.
 1. Decimal point position and unit of PV, SP, and OUT values.
 2. High and low limits of the control span.
 3. Control mode (single loop control, cascade control, etc.). Referred to as UT mode on the UT series.
 4. Control output type.
 5. Alarm type.
 - The setup information can also be entered using the operation keys.
 - Based on the setup information that is automatically read, [Parameter address setting] and [Tuning setting] are also automatically set.
- **When the connecting model is “ETC”**

Auto reading cannot be performed. You can only enter the items of 1 and 2 above using the operation keys.

External Loop Setting (Parameter Address Setting) Display

You can set the register address of the setup information that is required for monitoring on the control group display, control overview display, and tuning display.

- **When the connecting model is UT Series**
 - If [Auto setting] is executed, the register addresses of the following setup information are set automatically according to the various information that was read automatically on the External loop setting (Basic setting) display. The register addresses are set automatically also by executing [Auto reading] on the External loop setting (Basic setting) display.
 1. PV: Process value
 2. SP: (Target) Setpoint
 3. OUT: Output
 4. Control mode
 5. Remote/Local
 6. Operation STOP/RUN
 7. Alarm status
 8. SP number
 9. PID number
 10. Auto reading
 - The setup information can also be entered using the operation keys.
- **When the connecting model is “ETC”**

Automatic setting is not possible. You can only enter the items of 1, 2, and 3 above using the operation keys.

External Loop Setting (Tuning Setting) Display

You can set up to 21 turning parameters.

- **When the connecting model is UT Series**

- Select the turning parameters from below. Item ID is indicated inside the parentheses.
Target setpoint (SP), alarm value 1 (A1), alarm value 2 (A2), alarm value 3 (A3), alarm value 4 (A4), proportional band (P), integral time (I), derivative time (D), output high-limit (OH), output low-limit (OL), manual reset (MR), relay hysteresis (H), control direction (DR), dead band (DB), preset output (PO), and others (ETC)
- If you select an item ID from “SP, A1, A2, A3, A4, P, I, D, OH, OL, MR, H, DR, DB, and PO,” the preset setup information is assigned to the detail information items (item name, register address, decimal point position, high and low limits of the value range). If the item ID is “ETC,” use the operation key to enter the values.
- If [Auto setting] is executed, the detail information (such as the register address) of each tuning parameter is set automatically according to the various information that was read automatically on the External loop setting (Basic setting) display. The register addresses are set automatically also by executing [Auto reading] on the External loop setting (Basic setting) display.

- **When the connecting model is “ETC”**

The item ID is fixed to ETC (others). Set the detail information items (item name, register address, decimal point position, and high and low limits of the value range) using the operation keys.

Limitations

- The control from the CX to the UT series may not work precisely, if the UT series model is set as follows.
When control mode switching (manual/auto/cascade switching, remote/local switching, or run start/stop switching) or target setpoint number switching is enabled using external contact input.
- When the connecting model is UT series, the CX also performs a range check on the UT parameters that can be changed on the control group display, control overview display, and tuning display. However, for the following parameters, the CX cannot perform the same checks that the UT performs, because the CX does not have the relevant setup information.
 - When set to SP, the CX cannot perform a range check on SPH (SP high-limit) and SPL (SP low-limit). The UT320, UT321, UT350, and UT351 cannot perform these range checks either.
 - The CX cannot check whether OH (output high-limit) is greater than OL (output low-limit) of the PID parameter. The UT320, UT321, UT350, and UT351 do not perform these checks either.
 - The PID group number is 1 to 4 on the UT320, UT321, UT350, and UT351; it is 1 to 8 on other UTs. Even if you change the PID group on the UT side, the change is not passed on to the CX.
 - When set to manual output, the CX cannot perform a range check on OTH (output high-limit) and OTL (output low-limit).

9.2 Setup Procedure of the Green Series Communication Function

Set up the Green Series communications in the following order.

- 1. Connect the external devices (controllers) using the serial interface.**
Connect multiple devices with the CX as the host computer. For a description of how to connect the devices, see section 3.3, "Terminal Arrangement and Signal Names and the Connection Procedure of the RS-422/485 Interface."
- 2. Set the serial interface.**
Set the serial interface according to the communication condition of the CX and the connecting models. Set the protocol of the CX to Modbus master; set the protocol of the connecting models to Modbus slave. For a description of the serial interface settings of the CX, see section 3.5, "Configuring the Serial Interface."
- 3. Enter the Modbus master settings.**
Set the CX to Modbus master. For the procedure, see sections 9.3, "Setting the Modbus Master."
- 4. Set parameters related to external loops.**
Enter settings for operating and monitoring the control loops of the connecting models. For the procedure, see the descriptions on setting various parameters related to external loops in section 9.4 to 9.6.
- 5. Check the operating conditions of the Green Series communication function.**
See section 9.7, "Checking the Operating Conditions of the Green Series Communication Function."
- 6. Start the operation.**
See section 9.8, "Starting the Operation."
- 7. As necessary, carry out tasks during operation.**
See section 9.9, "Carrying Out Tasks during Operation."

9.3 Setting the Modbus Master

Setting the Protocol

To perform Green Series communications, set the protocol of the CX to [Modbus-M]. For the procedure, see section 4.2, "Setting the Modbus Protocol." Connect external devices to the CX as Modbus slaves.

Setting the Modbus Master Function

When using the CX as a Modbus master, set the read cycle, timeout time, and retries. For the procedure, see section 4.3, "Setting the Modbus Master Function."

Setting Commands

You must set commands when reading the measured data from the connecting model as communication input data of the CX. Set the channel for reading the data, the addresses of the connected Modbus slave devices, register addresses, and data type. For the procedure, see section 4.3, "Setting the Modbus Master Function."

Note

If you are using the UT Series, a read cycle of 1 s is recommended for every 4 loops connected. However, communications with the UT320 and UT350 takes twice the amount of time as other UT series instruments, so a read cycle of 2 s is recommended when using the UT320 or UT350 with 4 loops connected.

9.4 External Loop Setting > Basic Setting

Explanation

External loop control refers to operating and monitoring of control loops of connecting models in the same fashion as internal loops by connecting slave devices (controllers) to the CX and using Modbus communications between the CX and the connecting models. The external loop control function enables you to retrieve the setup information of the connecting models and correct the setup information.

Note

To retrieve various setup information by executing "Auto reading" on the External loop setting (Basic setting) display, the serial interface and Modbus master settings must be ready. Set the serial interface and the Modbus master function and save the settings by pressing the [End] soft key on the basic setting menu. Then, return to the External loop setting (Basic setting) display and execute "Auto reading."

In the external loop control function, the connecting models are set as external loops. The following basic settings must be entered.

Selecting the Loop Number

Select the external communication loop number from the following:
Ext1 to Ext16 (Ext1 to Ext4 on the CX1000)

Turning Off/On Communications

- **On**
The succeeding setup items appear, and Modbus communication is enabled with the device connected to the selected loop number.
- **Off**
Modbus communication is disabled. The succeeding setup items do not appear.

Setting the Modbus Address

Select the Modbus address of the connecting model from the following range:
1 to 247

Selecting the Connecting Model

Select the connecting model to communicate with from the following. Since the functions of the UT Series controller vary depending on the model, the succeeding setup parameters vary.
UT320, UT321, UT350, UT351, UT420, UT450, UT520, UT550, UT750, and ETC

Selecting the Loop

If the connecting model supports 2 loops, select the loop to be used from the following:
First and Second

Setting the Tag and Tag Comment

Set the tag and tag comment using up to 8 alphanumeric characters.

Executing Auto Reading

- **When the connecting model is UT Series**
 - Various setup information can be automatically read from the connected device. If you specify the [Modbus address] on the External loop setting (Basic setting) display and execute [Auto reading], the CX, which is set to be the Modbus master, reads the following setup information from the connected device automatically.
 1. Type of instrument connected.
 2. Decimal point position and unit of PV, SP, and OUT values.
 3. High and low limits of the control span.
 4. Control mode (single loop control, cascade control, etc.). Referred to as the UT mode on the UT series.
 5. Control output type
 6. Alarm type
 - The setup information can also be entered using the operation keys.
 - Based on the setup information that is automatically read, [Parameter address setting] and [Tuning setting] are also automatically set.
 - Even if the instrument connected is of the UT series, if using “heating/cooling control” or “custom computation control,” ETC is set for the connection type.
- **When the connecting model is “ETC”**
Auto reading cannot be performed. You can only enter the items of 1 and 2 above using the operation keys.

Setting (Correcting) the Read Data

If the data is not read correctly using the auto reading function, the following items can be entered (corrected) using the operation keys.

- **Decimal point position of PV (process value), SP (setpoint), and OUT (control output).**
You can set the decimal point position in the range of 0 to 4.
 - No decimal point when set to 0.
 - One digit to the right of the decimal when set to 1.
 - Two digits to the right of the decimal when set to 2.
 - Three digits to the right of the decimal when set to 3.
 - Four digits to the right of the decimal when set to 4.
- **Unit of PV (process value), SP (setpoint), and OUT (control output).**
Set the unit using up to 6 alphanumeric characters.
- **High and Low Limits of the Control Span**
 - Set the limits in the range of –30000 to 30000.
 - The decimal point position of PV above is used. For example, if the decimal point position is set to “1” and you enter “10000,” it is taken to be “1000.0”.

9.4 External Loop Setting > Basic Setting

• **Control mode**

- If the connecting model is UT series, select from the below. However, the selectable items vary depending on the connecting model. See the UT Series user's manual.

Control Mode	Soft Key Menu*
Single-loop control	SingleLoopControl
Cascade-primary loop control	CascadePrimaryLoop
Cascade secondary-loop control	CascadeSecondaryLoop
Cascade control	CascadeControl
Loop control for backup	ControlBackUp
Loop control with PV switching	PVSwitching
Loop control with PV auto-selector	PVAutoSelector
Loop control with PV-hold function	PVHoldFunction
Dual loop control	DualLoopControl
Temperature and Humidity control	Temperature-Humidity
Cascade control with two universal inputs	Cascade-2Uni
Loop control with PV switching and two universal inputs	PVSwitching-2Uni
Loop control with PV auto-selector and two universal inputs	PVAutoSelector-2Uni

* Some of the displayed characters are abbreviated even further on the CX1000.

- If the connecting model is "ETC," you cannot select the control mode.
- The status display on the operation display of the CX and the soft key menus vary depending on the UT series model and control mode as shown below.

Model	Control Mode (UT Mode)	MODE		REM/LOC		RUN/STP		SP		OUT		AUTO TUN		SP NO.		GROUP NO.	
		Dsp.	Opr.	Dsp.	Opr.	Dsp.	Opr.	Dsp.	Opr.	Dsp.	Opr.	Dsp.	Opr.	Dsp.	Opr.	Dsp.	Opr.
UT3□0	SingleLoopControl	Y	Y	Y	N	Y	Y	Y	Y	Y	Y	Y	Y	Y	Y	Y	Y
UT3□1	SingleLoopControl	Y	Y	Y	N	Y	Y	Y	Y	Y	Y	Y	Y	Y	Y	Y	Y
UT4□0	SingleLoopControl	Y	Y	Y	Y	Y	Y	Y	Y	Y	Y	Y	Y	Y	Y	Y	Y
UT5□0	SingleLoopControl	Y	Y	Y	Y	Y	Y	Y	Y	Y	Y	Y	Y	Y	Y	Y	Y
	CascadePrimaryLoop	Y	Y	Y	N	Y	Y	Y	Y	Y	Y	Y	Y	Y	Y	Y	Y
	CascadeSecondaryLoop	Y	Y	N	N	Y	Y	Y	Y	Y	Y	Y	Y	Y	Y	Y	Y
	CascadeControl Primary		Y	N	Y	N	N	Y	Y	Y	N	Y	Y	Y	Y	Y	Y
		Secondary	Y	Y	N	N	Y	Y	Y	Y	Y	Y	Y	Y	Y	Y	Y
	ControlBackUp	Y	Y	Y	N	Y	Y	Y	Y	Y	Y	Y	Y	Y	Y	Y	Y
	PVSwitching	Y	Y	Y	N	Y	Y	Y	Y	Y	Y	Y	Y	Y	Y	Y	Y
	PVAutoSelector	Y	Y	Y	N	Y	Y	Y	Y	Y	Y	Y	Y	Y	Y	Y	Y
PVHoldFunction	Y	Y	Y	Y	Y	Y	Y	Y	Y	Y	Y	Y	Y	Y	Y	Y	
UT750	SingleLoopControl	Y	Y	Y	Y	Y	Y	Y	Y	Y	Y	Y	Y	Y	Y	Y	Y
	CascadePrimaryLoop	Y	Y	Y	Y	Y	Y	Y	Y	Y	Y	Y	Y	Y	Y	Y	Y
	CascadeSecondaryLoop	Y	Y	N	N	Y	Y	Y	Y	Y	Y	Y	Y	Y	Y	Y	Y
	CascadeControl Primary		Y	N	Y	Y	N	N	Y	Y	Y	N	Y	Y	Y	Y	Y
		Secondary	Y	Y	N	N	Y	Y	Y	Y	Y	Y	Y	Y	Y	Y	Y
	ControlBackUp	Y	Y	Y	Y	Y	Y	Y	Y	Y	Y	Y	Y	Y	Y	Y	Y
	PVSwitching	Y	Y	Y	Y	Y	Y	Y	Y	Y	Y	Y	Y	Y	Y	Y	Y
	PVAutoSelector	Y	Y	Y	Y	Y	Y	Y	Y	Y	Y	Y	Y	Y	Y	Y	Y
	DualLoopControl 1st		Y	Y	Y	Y	Y	Y	Y	Y	Y	Y	Y	Y	Y	Y	Y
		2nd	Y	Y	Y	Y	Y	Y	Y	Y	Y	Y	Y	Y	Y	Y	Y
	Temperature-Humidity 1st		Y	Y	Y	Y	Y	Y	Y	Y	Y	Y	Y	Y	Y	Y	Y
		2nd	Y	Y	Y	Y	Y	Y	Y	Y	Y	Y	Y	Y	Y	Y	Y
	Cascade-2Uni Primary		Y	N	Y	Y	N	N	Y	Y	Y	N	Y	Y	Y	Y	Y
		Secondary	Y	Y	N	N	Y	Y	Y	Y	Y	Y	Y	Y	Y	Y	Y
	PVSwitching-2Uni	Y	Y	Y	Y	Y	Y	Y	Y	Y	Y	Y	Y	Y	Y	Y	Y
	PVAutoSelector-2Uni	Y	Y	Y	Y	Y	Y	Y	Y	Y	Y	Y	Y	Y	Y	Y	Y

Dsp.: Indication on the display (Y/N)

Opr.: Function key display for control at the lower section of the display (Y/N)

• **Control output type**

- If the connecting model is UT series, select from the following:

Control Output Type	Soft Key Menu
Time proportional PID relay contact output	Relay
Time proportional PID voltage pulse output	Voltage-pulse
Current output	Current-output
On/Off-control relay contact output	On/Off-control

- If the connecting model is “ETC,” you cannot select the control output type.

• **Alarm type**

- If the connecting model is UT series, select from the following. However, the selectable items vary depending on the connecting model. See the UT Series user’s manual.

Alarm Type	Soft Key Menu*
Off	Off
PV high-limit alarm (energize)	PV-H-E
PV low-limit alarm (energize)	PV-L-E
Deviation high-limit alarm (energize)	Dev-H-E
Deviation low-limit alarm (energize)	Dev-L-E
Deviation high-limit alarm (deenergize)	Dev-H-D
Deviation low-limit alarm (deenergize)	Dev-L-D
Deviation high & low limit alarm (energize)	Dev-HL-E
Deviation within high & low limits alarm (energize)	D-W-HL-E
PV high-limit alarm (deenergize)	PV-H-D
PV low-limit alarm (deenergize)	PV-L-D
PV high-limit alarm (energize/hold)	PV-H-ES
PV low-limit alarm (energize/hold)	PV-L-ES
Deviation high-limit alarm (energize/hold)	Dev-H-ES
Deviation low-limit alarm (energize/hold)	Dev-L-ES
Deviation high-limit alarm (deenergize/hold)	Dev-H-DS
Deviation low-limit alarm (deenergize/hold)	Dev-L-DS
Deviation high & low limit alarm (energize/hold)	Dev-HL-ES
Deviation within high & low limits alarm (energize/hold)	D-W-HL-ES
PV high-limit alarm (deenergize/hold)	PV-H-DS
PV low-limit alarm (deenergize/hold)	PV-L-DS
Timer, upward detection, hours & minutes	TimeUp1
Timer, downward detection, hours & minutes	TimeDown1
Timer, upward detection, minutes & seconds	TimeUp2
Timer, downward detection, minutes & seconds	TimeDown2
Sensor grounding alarm	Sensor
Self diagnosis output	Prog-Diag
FAIL output	FAIL
SP high-limit	SP-H
SP low-limit	SP-L
Output high-limit	Out-H
Output low-limit	Out-L
Heater burnout alarm 1	Burnout1
Heater burnout alarm 2	Burnout2

* Some of the displayed characters are abbreviated even further on the CX1000.

- If the connecting model is UT320, UT321, UT350, UT351, or UT420, you cannot set alarm number 4.
- If the connecting model is UT420, UT450, UT520, UT550, or UT750, you can set the timer function alarm type only for alarm number 1.
- The heater burnout alarms can be used if the connecting model is UT320, UT321, UT350, or UT351.
- If the connecting model is “ETC,” you cannot select the alarm type.

Procedure

For the basic flow of operation, see “Setup Procedure Using Operation Keys” on page ix.

1. Press the MENU key.
The Setting mode (Control) display appears.
2. Press the FUNC key for approximately 3 s.
The Basic setting menu appears.
3. Press the [#10] (Control) soft key ([#12] (Control) soft key on the CX1000).
The Control menu appears.
4. Press the [#6] (External loop setting) soft key ([#8] (External loop setting) soft key on the CX1000).
The Control (External loop setting) menu appears.
5. Press the [#1] (Basic setting) soft key.
The External loop setting (Basic setting) display appears.

CX1000 Basic setting display (when Comm. is set to On)

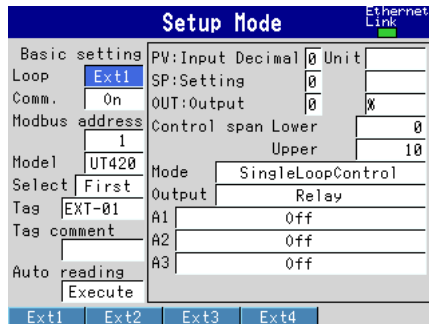

CX2000 External loop setting (Basic setting) display (when Comm. is set to On)

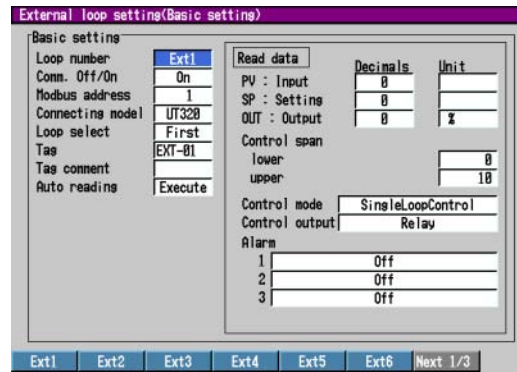

Selecting the Loop Number

6. Use the arrow keys to move the cursor to the [Loop number] box.

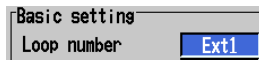

7. Press one of the soft keys from [Ext1] to [Ext16] ([Ext1] to [Ext4] on the CX1000) to select the external loop number.



Turning Off/On Communications

8. Use the arrow keys to move the cursor to the [Comm. On/Off] box.

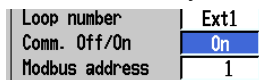

9. Press the [Off] or [On] soft key.
If you selected [On], proceed to step 10; if you selected [Off], proceed to step 26.



Setting the Modbus Address

- Use the arrow keys to move the cursor to the [Modbus address] box.

Comm. Off/On	On
Modbus address	1
Connecting model	UT320

- Press the [Input] soft key. An entry box (numeric value input pop-up window) appears.

Input

- Enter the Modbus address of the controller.
- Press the DISP/ENTER key. On the CX1000, select [ENT] and then press the DISP/ENTER key.
The Modbus address that you entered is displayed in the [Modbus address] box.

Selecting the Connecting Model

- Use the arrow keys to move the cursor to the [Connecting model] box.

Modbus address	2
Connecting model	UT320
Loop select	First

- Press one of the soft keys from [UT320] to [ETC] to select the connecting model.

UT320	UT350	UT420	UT450	UT520	UT550	Next 1/2
<input type="text"/>	<input type="text"/>	<input type="text"/>	<input type="text"/>	<input type="text"/>	<input type="text"/>	<input type="text"/>

Selecting the Loop

- Use the arrow keys to move the cursor to the [Loop select] ([Select] on the CX1000) box.

Connecting model	UT520
Loop select	First
Tag	EXT-01

- Press the [First] or [Second] loop soft key to select the loop to be used. For UT320 to UT450, select only [First]. For UT520 to UT750, select [First] or [Second].

First	Second
<input type="text"/>	<input type="text"/>

Entering the Tag and Tag Comment

- Use the arrow keys to move the cursor to the [Tag] or [Tag comment] box.

Loop select	First
Tag	EXT-01
Tag comment	
Auto reading	Execute

- Press the [Input] soft key. An entry box appears.

Input			Clear	Copy
<input type="text"/>	<input type="text"/>	<input type="text"/>	<input type="text"/>	<input type="text"/>

- Enter the tag or tag comment in the entry box.

9.4 External Loop Setting > Basic Setting

- Press the DISP/ENTER key. On the CX1000, select [ENT] and then press the DISP/ENTER key.
The characters that you entered are displayed in the respective boxes.
To clear the characters that you entered, press the [Clear] soft key.
To copy the characters, press the [Copy] soft key. The [Paste] soft key appears.
The copied characters can be pasted to boxes in which characters are entered.

Executing Auto Reading

(Applicable only to UT Series.)

- Use the arrow keys to move the cursor to the [Auto reading] box.

Tag comment	
Auto reading	Execute

- Press the [Execute] soft key.
The setup information of the connecting model is read automatically.

Execute

Note

The [Execute] soft key is used read the setup information of the connecting model automatically. Use caution, because the preexisting data will be overwritten.

Setting (Correcting) the Read Data

(Perform the following procedures only if parameters need to be corrected.)

- Enter the following parameters according to the selected connecting model.
Decimal point position of PV (process value), SP (setpoint), and OUT (control output).

Read data	Decimals	Unit
PV : Input	0	
SP : Setting	0	
OUT : Output	0	%

0	1	2	3	4

Unit of PV (process value), SP (setpoint), and OUT (control output).

Read data	Decimals	Unit
PV : Input	0	
SP : Setting	0	
OUT : Output	0	%

Input			Clear	Copy

High and low Limits of the control span

OUT : Output	0	%
Control span		
lower		0
upper		10
Control mode	SingleLoopControl	

Input

25. If you selected a UT Series controller for the connecting model, set the control mode, control output type, and alarm type.

Control mode	SingleLoopControl
Control output	Relay
Alarm	
1	Off
2	PV-High(Energ)
3	PV-Low(Energ)
4	Deviation-High(Energ)

Confirming or Canceling the Settings

26. To confirm the new settings, press the DISP/ENTER key. To cancel the settings, press the ESC key.
 For a detailed procedure in confirming or canceling settings, see “Setup Procedure Using Operation Keys” on page ix.

Saving the Settings

27. Press the ESC key several times to display the basic setting menu.
28. Press the [End] soft key. A dialog box appears for you to select whether to save the settings.

End
<input type="radio"/>

29. To save the settings, select [Yes]. To not save the settings, select [No]. To return to the basic setting menu, select [Cancel]. Then, press the DISP/ENTER key.

Do you want to store and make the new settings take effect?		
Yes	No	Cancel

Note

To activate the settings that have been changed in the basic setting mode, the settings must be saved. Otherwise, the settings that existed before the change are activated.

9.5 External Loop Setting > Parameter Address Setting

Explanation

You can set the register address of the setup information that is required for monitoring on the control group display, control overview display, and tuning display.

Note

To set various setup information by executing "Auto setting" on the External loop setting (Parameter address setting) display, the serial interface and Modbus master settings must be ready. Set the serial interface and the Modbus master function and save the settings by pressing the [End] soft key on the basic setting menu. Then, return to the External loop setting (Parameter address setting) display and execute "Auto setting."

Selecting the Loop Number

Select the external communication loop number for setting the register address from the following:

Ext1 to Ext16 (Ext1 to Ext4 on the CX1000)

Executing Auto Setting

- **When the connecting model is UT Series**
 - The register addresses (register numbers) of the following setup information are set automatically according to the various information that was read automatically on the External loop setting (Basic setting) display.
 1. PV: Process value
 2. SP: (Target) Setpoint
 3. OUT: Output
 4. Control mode
 5. Remote/Local
 6. Operation STOP/RUN
 7. Alarm status
 8. SP number
 9. PID number
 10. Auto reading
 - The setup information can also be entered using the operation keys.
 - The register addresses are set automatically also by executing [Auto reading] on the External loop setting (Basic setting) display.
- **When the connecting model is "ETC"**

Automatic setting is not possible. You can only enter the items of 1, 2, and 3 above using the operation keys.

Setting (Correcting) Register Addresses

- If the data is not set correctly using auto setting, you can set (correct) the register address (register number) of each item using the operation keys.
- You can set the register address in the following range.
30001 to 39999, 40001 to 49999, 300001 to 365535, 400001 to 465535
- When the connecting model is "ETC," you can set only the following three parameters using the operation keys: PV, SP, and OUT.

Procedure

For the basic flow of operation, see “Setup Procedure Using Operation Keys” on page ix.

1. Press the MENU key.
The Setting mode (Control) display appears.
2. Press the FUNC key for approximately 3 s.
The Basic setting menu appears.
3. Press the [#10] (Control) soft key ([#12] (Control) soft key on the CX1000).
The Control menu appears.
4. Press the [#6] (External loop setting) soft key ([#8] (External loop setting) soft key on the CX1000).
The Control (External loop setting) menu appears.
5. Press the [#2] (Parameter address setting) soft key.
The External loop setting (Parameter address setting) display appears.

CX1000 Parameter address setting display

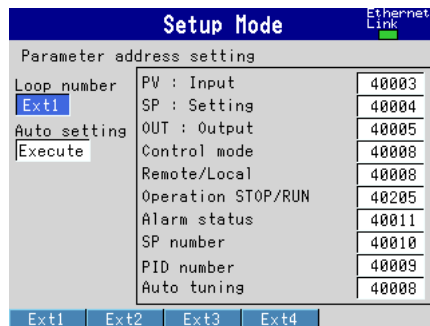

CX2000 External loop setting (Parameter address setting) display

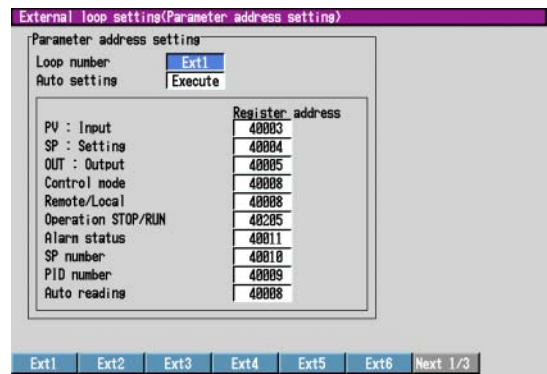

Selecting the Loop Number

6. Use the arrow keys to move the cursor to the [Loop number] box.

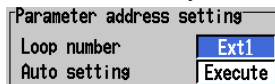

7. Press one of the soft keys from [Ext1] to [Ext16] ([Ext1] to [Ext4] on the CX1000) to select the external loop number.



Executing the Auto Setting
(Applicable only to UT Series.)

- Use the arrow keys to move the cursor to the [Auto setting] box.

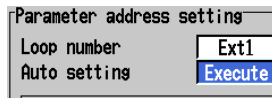

- Press the [Execute] soft key.
 The register addresses of the connecting model are set automatically.
 The register addresses are set automatically according to the various information that was read automatically on the External loop setting (Basic setting) display.)



Note

The [Execute] soft key is used read the register addresses of the connecting model automatically. Use caution because all preexisting register addresses will be overwritten.

Setting (Correcting) Register Addresses

(Perform the following procedures only if addresses need to be corrected.)

- Enter the register address of each item according to the selected connecting model (see section 9.4).

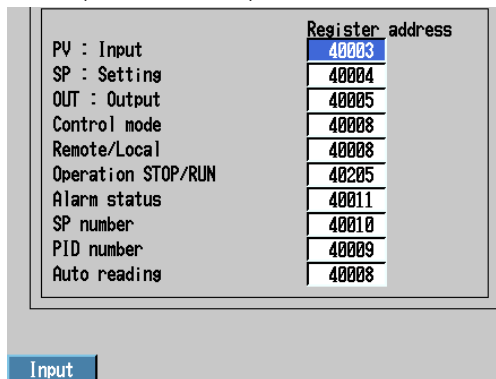

Confirming or Canceling the Settings

- To confirm the new settings, press the DISP/ENTER key. To cancel the settings, press the ESC key.
 For a detailed procedure in confirming or canceling settings, see "Setup Procedure Using Operation Keys" on page ix.

Saving the Settings

- Press the ESC key several times to display the basic setting menu.
- Press the [End] soft key. A dialog box appears for you to select whether to save the settings.



- To save the settings, select [Yes]. To not save the settings, select [No]. To return to the basic setting menu, select [Cancel]. Then, press the DISP/ENTER key.

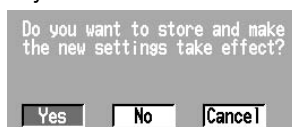

Note

To activate the settings that have been changed in the basic setting mode, the settings must be saved. Otherwise, the settings that existed before the change are activated.

9.6 External Loop Setting > Tuning Setting

Explanation

You can set up to 21 turning parameters.

Note

To set various setup information by executing "Auto setting" on the External loop setting (Tuning setting) display, the serial interface and Modbus master settings must be ready. Set the serial interface and the Modbus master function and save the settings by pressing the [End] soft key on the basic setting menu. Then, return to the External loop setting (Tuning setting) display and execute "Auto setting."

Selecting the Loop Number

Select the external communication loop number for setting the tuning parameters from the following:

Ext1 to Ext16 (Ext1 to Ext4 on the CX1000)

Executing Auto Setting

- **When the connecting model is UT Series**
 - The detail information (item ID, item name, register address, decimal point position, high and low limits of value range) of tuning parameters is set automatically according to the various information that was read automatically on the External loop setting (Basic setting) display.
 - The detail setup information can also be entered using the operation keys.
 - The register addresses are set automatically also by executing [Auto reading] on the External loop setting (Basic setting) display.
 - For the types of tuning parameters and item IDs, see the next page.
 - If the tuning item is set to "ETC," set the detail information (item name, register address, decimal point position, and high and low limits of the value range) using the operation keys.
- **When the connecting model is "ETC"**

Automatic setting is not possible. The only tuning item you can set is "ETC." Set the detail information items (item name, register address, decimal point position, and high and low limits of the value range) using the operation keys.

Turning On/Off the Tuning Parameters

- **On**

The item name of each tuning parameter is displayed, you can display and set (correct) the detail information.
- **Off**

The item name of each tuning parameter is not displayed. Detail information is also not displayed.

Setting (Correcting) the Detail Information

- If the data is not set correctly using auto setting, you can set (correct) the items using the operation keys.
- Select the turning parameters from the following:

Tuning parameter	Soft Key Menu (Item ID)
Target setpoint	SP
Alarm value 1	A1
Alarm value 2	A2
Alarm value 3	A3
Alarm value 4	A4
Proportional band	P
Integral time	I
Derivative time	D
Output high-limit	OH
Output low-limit	OL
Manual reset	MR
Relay hysteresis	H
Control direction	DR
Dead band	DB
Preset output	PO
Others	ETC

- If you select an item ID (tuning parameter) from “SP, A1, A2, A3, A4, P, I, D, OH, OL, MR, H, DR, DB, and PO,” the preset setup information is assigned to the detail information items (item name, register address, decimal point position, high and low limits of the value range).
- If the connecting model is UT320, UT321, UT350, UT351, or UT420, you cannot set the tuning parameter of alarm value 4 (A4).
- When the connecting model is “ETC,” you can only set “ETC” for the tuning parameter.

• **Item ID**

Item IDs are used to display the tuning parameters on the setting display of the CX. A list of tuning parameters and item ID is indicated above.

• **Item name**

You can set the name of the tuning parameter using up to 6 alphanumeric characters.

• **Registers address**

You can set the register address in the following range.
30001 to 39999, 40001 to 49999, 300001 to 365535, 400001 to 465535

• **Decimal point**

Set the decimal point position in the range of 0 to 4.

- No decimal point when set to 0.
- One digit to the right of the decimal when set to 1.
- Two digits to the right of the decimal when set to 2.
- Three digits to the right of the decimal when set to 3.
- Four digits to the right of the decimal when set to 4.

• **Range lower and upper**

- Set the limits in the range of –30000 to 30000.
- The decimal point position above is used. For example, if the decimal point position is set to “1” and you enter “10000,” it is taken to be “1000.0”.

Procedure

For the basic flow of operation, see “Setup Procedure Using Operation Keys” on page ix.

1. Press the MENU key.
The Setting mode (Control) display appears.
2. Press the FUNC key for approximately 3 s.
The Basic setting menu appears.
3. Press the [#10] (Control) soft key ([#12] (Control) soft key on the CX1000).
The Control menu appears.
4. Press the [#6] (External loop setting) soft key ([#8] (External loop setting) soft key on the CX1000).
The Control (External loop setting) menu appears.
5. Press the [#3] (Tuning setting) soft key.
The External loop setting (Tuning setting) display appears.

CX1000 Tuning setting display

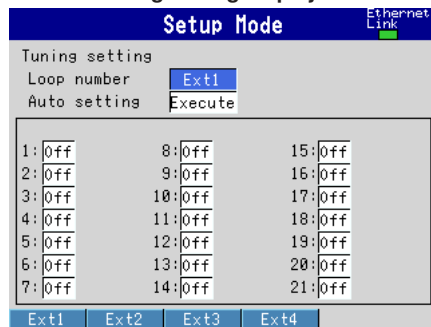

CX2000 External loop setting (Tuning setting) display

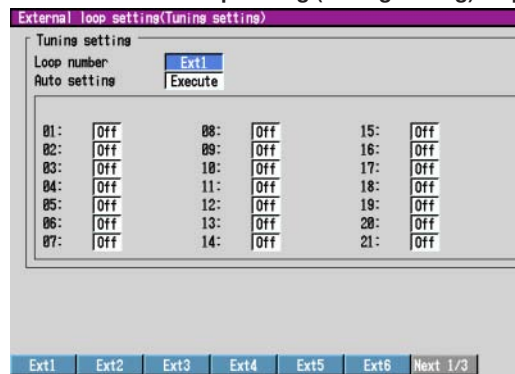

Selecting the Loop Number

6. Use the arrow keys to move the cursor to the [Loop number] box.

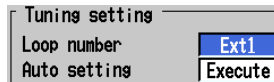

7. Press one of the soft keys from [Ext1] to [Ext16] ([Ext1] to [Ext4] on the CX1000) to select the external loop number.



Executing the Auto Setting
(Applicable only to UT Series.)

- Use the arrow keys to move the cursor to the [Auto setting] box.

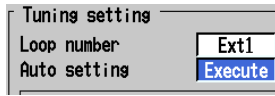

- Press the [Execute] soft key.
 The detail information (item ID, item name, register address, decimal point position, and high and low limits of value range) of the tuning parameters of the connecting model is set automatically.
 The detail information is set automatically according to the various information that was read automatically on the External loop setting (Basic setting) display.)



Note

The [Execute] soft key is used read the detail information of the connecting model automatically. Use caution because all preexisting detail information will be overwritten.

Turning On/Off the Tuning Parameters

- Use the arrow keys to move the cursor to each tuning parameter box.

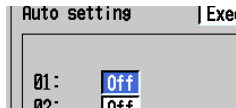

- Press the [On] or [Off] soft key.
 If you selected [On], the cursor moves to the [Item name] box and the [Detail] soft key appears. Proceed to step 12.
 If you selected the [Off], proceed to step 13.

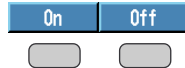

Setting (Correcting) the Detail Information

(Perform the following procedures only if parameters need to be corrected.)

- Press the [Detail] soft key. An entry box appears. Set [Item ID], [Item name], [Register address], [Decimal point], and [Range lower/upper].

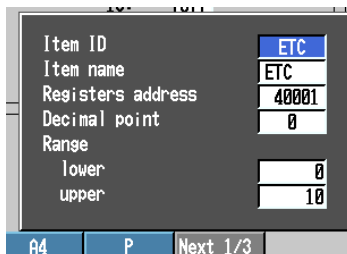

Confirming or Canceling the Settings

13. To confirm the new settings, press the DISP/ENTER key. To cancel the settings, press the ESC key.

For a detailed procedure in confirming or canceling settings, see “Setup Procedure Using Operation Keys” on page ix.

Saving the Settings

14. Press the ESC key several times to display the basic setting menu.
15. Press the [End] soft key. A dialog box appears for you to select whether to save the settings.

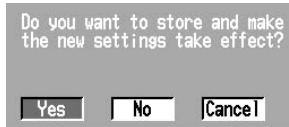

16. To save the settings, select [Yes]. To not save the settings, select [No]. To return to the basic setting menu, select [Cancel]. Then, press the DISP/ENTER key.

**Note**

To activate the settings that have been changed in the basic setting mode, the settings must be saved. Otherwise, the settings that existed before the change are activated.

9.7 Checking the Operating Conditions of the Green Series Communication Function

Explanation

“EXTLOOP STATUS” Display

You can check the operating conditions of the Green Series communication function on the “EXTLOOP STATUS” display.

CX2000 screen example

On the CX1000, up to loop 4 is displayed.

Communication condition

Read cycle : 5s	←
Time out : 2s	
Retrials : 1	

No.	Status	Slave Address	No.	Status	Slave Address
1	● Good	1	9	● Good	16
2	● Good	2	10	● Good	17
3	● Good	3	11	● Good	24
4	● Good	4	12	● Good	25
5	● Good	5	13	● Good	30
6	● Good	6	14	● Good	31
7	● Good	7	15	● Good	32
8	● None	15	16	● Good	48

↑ ↑ ↑ ↑
Status lamp Detail code Controller address

Communication Status

The communication status is displayed using the status lamp and the detail code.

Status Lamp	Detail Code	Meaning
Green	GOOD	Communication is operating normally.
Yellow		Retrying.
Red		Communications stopped since communications did not recover after the specified number of retries.
	NONE	No response from the controller.
	FUNC	The controller cannot execute the command from the CX.
	REGI	The controller does not have the specified register.
	ERR	There is an error in the response data from the controller.
	(Space)	The detail code is not displayed until the status is confirmed when communication is started or during retrieval.

Resuming Command Transmission

You can use the front panel keys to resume command transmission to the controller (red status lamp) to which command transmission is stopped.

Data during Retrial and When Communication Is Stopped

The communication input data is held at the previous value during retrial. When command transmission is stopped, communication input data becomes error data. In this case, the data display shows “+*****.”

Data Dropout

If the communications with the controllers from 1 to 16 (1 to 4 on the CX1000) are not completed within the read cycle, data dropout occurs. When a data dropout occurs, the communication input data is held at the previous value. Set a longer read cycle or reduce the number commands so that communications with the controllers can be completed within the read cycle.

Procedure

Opening the “EXTLOOP STATUS” Display

1. Press the FUNC key. The FUNC menu appears. The structure of the FUNC menu varies depending on the basic settings and options.
2. Press the [EXT_Loop Commu] soft key. The “EXTLOOP STATUS” display appears.



Data Dropout

When a data dropout occurs, the message “Data dropout” is displayed on the “EXTLOOP STATUS” screen.



Press an arrow key. The message disappears.

Resuming Command Transmission to the Controller to Which Command Transmission Is Stopped due to Timeout

1. Select the controller whose transmission is to be resumed using the up and down arrow keys.

CX2000 screen example

On the CX1000, up to loop 4 is displayed.

No.	Status	Address	No.	Status	Address
1	● Good	1	9	● Good	16
2	● Good	2	10	● Good	17
→ 3	● None	3	11	● Good	24
4	● Good	4	12	● Good	25
5	● Good	5	13	● Good	26

A message “Push [right arrow] key to refresh” appears.

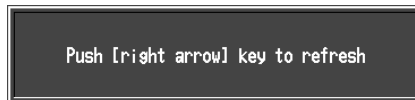

2. Press the right arrow key. The CX starts command transmission to the selected controller.

9.8 Starting the Operation

Note

Start the operation after completing the following settings and checking the operating conditions of the Green Series communication function (see section 9.7).

1. The serial interface and Modbus master settings must be ready. Set the serial interface and the Modbus master function and save the settings by pressing the [End] soft key on the basic setting menu.
2. After step 1, set the parameters related to external loops according to Basic setting (section 9.3), Parameter address setting (section 9.4), and Tuning setting (section 9.5).

Starting the Operation

Power cycle the CX and the connecting models.

Switching the Operation Mode (RUN/STOP)

If you change the operation mode on the CX, the operation mode on the connecting models also changes.

Limitations

- The control from the CX to the UT series may not work precisely, if the UT series model is set as follows. When using the Green series communication function of the CX, it is recommended that the UT series not be set as follows.
 - When control mode switching (auto/manual/cascade switching, remote/local switching, or run/stop switching) or target setpoint number switching is enabled using external contact input.
- When the connecting model is UT series, the CX also performs a range check on the UT parameters that can be changed on the control group display, control overview display, and tuning display. However, for the following parameters, the CX cannot perform the same checks that the UT performs, because the CX does not have the relevant setup information.
 - When set to SP, the CX cannot perform a range check on SPH (SP high-limit) and SPL (SP low-limit). The UT320, UT321, UT350, and UT351 cannot perform these range checks either.
 - The CX cannot check whether OH (output high-limit) is greater than OL (output low-limit) of the PID parameter. The UT320, UT321, UT350, and UT351 do not perform these checks either.
 - The PID group number is 1 to 4 on the UT320, UT321, UT350, and UT351; it is 1 to 8 on other UTs. Even if you change the PID group on the UT side, the change is not passed on to the CX.
 - When set to manual output, the CX cannot perform a range check on OTH (output high-limit) and OTL (output low-limit).

9.9 Operations That You Can Carry Out during Control Operation

During control operation, you can show the control status of the connecting models as external loops on the control group display. In addition, you can carry out operations related to control on the control group display in the same fashion as internal loops.

Operations on the Control Group Display

You can carry out the following operations on the control group display or the control overview display in the same fashion as internal loops. The operating procedure is the same as for internal loops. For details, see section 6.1, "Operations on the Control Group Display" in the *user's manual IM 04L31A01-01E* or *IM 04L31A01-03E*.

- Run/Stop the operation.
- Switch between auto, manual, and cascade control.
- Change the target setpoint.
- Change the control output.
- Switch between remote and local.
- Switch between tuning display and program control display.

Operations on the Tuning Display and Program Control Display

Tuning operations can be performed by switching from the control group display to the tuning display or program control display. For details, see section 6.3, "Tuning Operation" in the *user's manual IM 04L31A01-01E* or *IM 04L31A01-03E*.

Operation on the Tuning Display

- Auto tuning
- Manual tuning
- Change the target setpoint number and the PID number of the tuning parameter to be manipulated
- Run/Stop the operation
- Switch between auto and manual operation
- Change the control output
- Switch between remote and local

Alarm Indication

The following table shows the alarm indications on the display according to the alarm types.

Alarm Type	1-Character Indication	3-Character Indication
PV high-limit alarm (energize/nonhold)	H	PVH
PV low-limit alarm (energize/nonhold)	L	PVL
Deviation high-limit alarm (energize/nonhold)	D	DVH
Deviation low-limit alarm (energize/nonhold)	d	DVL
Deviation high-limit alarm (deenergize/nonhold)	D	DVH
Deviation low-limit alarm (deenergize/nonhold)	d	DVL
Deviation high & low limit alarm (energize/nonhold)	I	DVO
Deviation within high & low limits alarm (energize/nonhold)	i	DVI
PV high-limit alarm (deenergize/nonhold)	H	PVH
PV low-limit alarm (deenergize/nonhold)	L	PVL
PV high-limit alarm (energize/hold)	H	PVH
PV low-limit alarm (energize/hold)	L	PVL

(Continues on the next page)

9.9 Operations That You Can Carry Out during Control Operation

(Continuing from the previous page)

Alarm Type	1-Character Indication	3-Character Indication
Deviation high-limit alarm (energize/hold)	D	DVH
Deviation low-limit alarm (energize/hold)	d	DVL
Deviation high-limit alarm (deenergize/hold)	D	DVH
Deviation low-limit alarm (deenergize/hold)	d	DVL
Deviation high & low limit alarm (energize/hold)	I	DVO
Deviation within high & low limits alarm (energize/hold)	i	DVI
PV high-limit alarm (deenergize/hold)	H	PVH
PV low-limit alarm (deenergize/hold)	L	PVL
Timer, upward detection, hours & minutes	E	ETC
Timer, downward detection, hours & minutes	E	ETC
Timer, upward detection, minutes & seconds	E	ETC
Timer, downward detection, minutes & seconds	E	ETC
Sensor grounding alarm	E	ETC
Self diagnosis output	E	ETC
FAIL output	E	ETC
Heater burnout alarm 1	E	ETC
Heater burnout alarm 2	E	ETC
SP high-limit	H	SPH
SP low-limit	L	SP
Output high-limit	H	OTH
Output low-limit	L	OTL
Others	E	ETC

Error Messages during Display and Operation

The following table shows the error messages that may appear when you select to display or operate the external loops on the control group display or the tuning display of the operation display.

Display/Operation	Conditions in Which Display/Operation Cannot Be Performed (Condition That Lead to Errors)	Error Message	Corrective Action
Mode	None. Always possible.	–	–
Remote(REM)/ Local(LOC)	None. Always possible.	–	–
RUN/STOP	None. Always possible.	–	–
SP	During auto tuning	Can not operate in the present situation.	Stop auto tuning.
	When remote/local is “remote”	Can not operate in the present situation.	Set remote/local to “local.”
	When the secondary loop of cascade control is “CAS”	Can not operate in the present situation.	Set the mode to “AUT” or “MAN.”
OUT	When RUN/STOP is “STOP”	Can not operate in the present situation.	Set RUN/STOP to “RUN.”
	When the mode is other than “MAN”	Can not operate in the present situation.	Set the mode to “MAN.”
AT (auto tuning) (AUTO TUN)	None. Always possible.	–	–
SPNO	None. Always possible.	–	–
GROUPNO	None. Always possible.	–	–

Appendix 1 ASCII Character Codes

		Upper 4 bits															
		0	1	2	3	4	5	6	7	8	9	A	B	C	D	E	F
Lower 4 bits	0			SP	0	@	P		p								
	1				1	A	Q	a	q								
	2				2	B	R	b	r								
	3			#	3	C	S	c	s								
	4				4	D	T	d	t								
	5			%	5	E	U	e	u								
	6			&	6	F	V	f	v								
	7				7	G	W	g	w								
	8			(8	H	X	h	x								
	9)	9	I	Y	i	y								
	A	LF		*	:	J	Z	j	z								
	B		ESC	+		K		k									
	C					L		l									
	D	CR		-		M		m									
	E			.		N	°	n									
	F			/		O	-	o									

Appendix 2 Output Flow of Internal Memory Data

Display Data Example

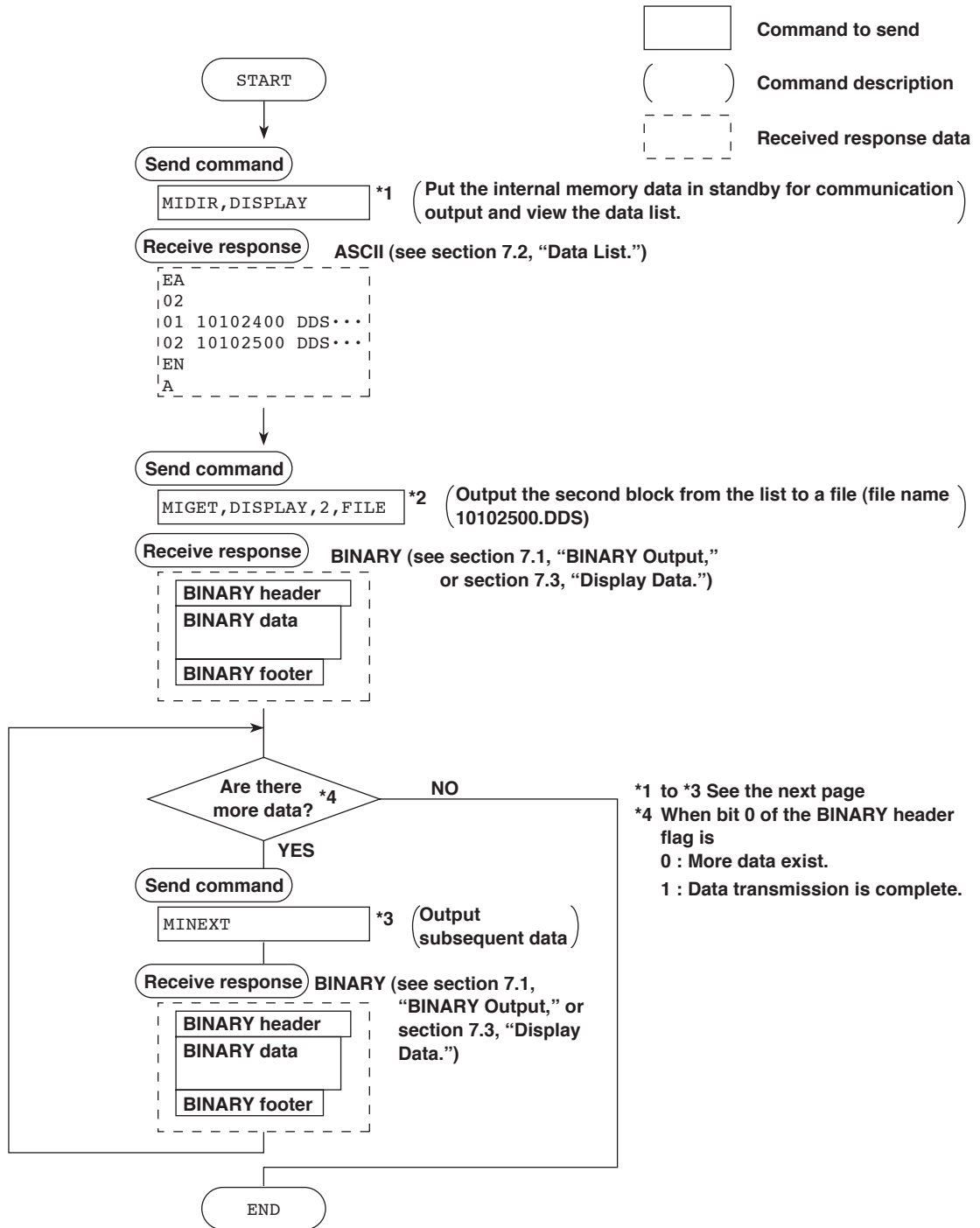

Event data (Set *1, *2, and *3 in the previous figure to the following commands)

- *1: MIDIR, EVENT Output the list.
- *2: MIGET, EVENT, 2, FILE Output the data of the second block to a file.
- *3: MINEXT If subsequent data exists, output the data.

Manual sampled data (Set *1 and *2 in the previous figure to the following commands)

- *1: MODIR, MANUAL
 - *2: MOGET, MANUAL, 2
- Since manual sampled data can be transmitted in one session, *3 is not necessary.

Report data (Set *1 and *2 in the previous figure to the following commands)

- *1: MODIR, REPORT
 - *2: MOGET, REPORT, 2
- Since report data can be transmitted in one session, *3 is not necessary.

TLOG data (Set *1, *2, and *3 in the previous figure to the following commands)

- *1: MODIR, TLOG
- *2: MOGET, TLOG, 2
- *3: MONEXT

Appendix 3 Output Flow of the File or the File List on the External Storage Medium

Example in Which the File 10101000.CDS in the DATA0 Directory Is Output

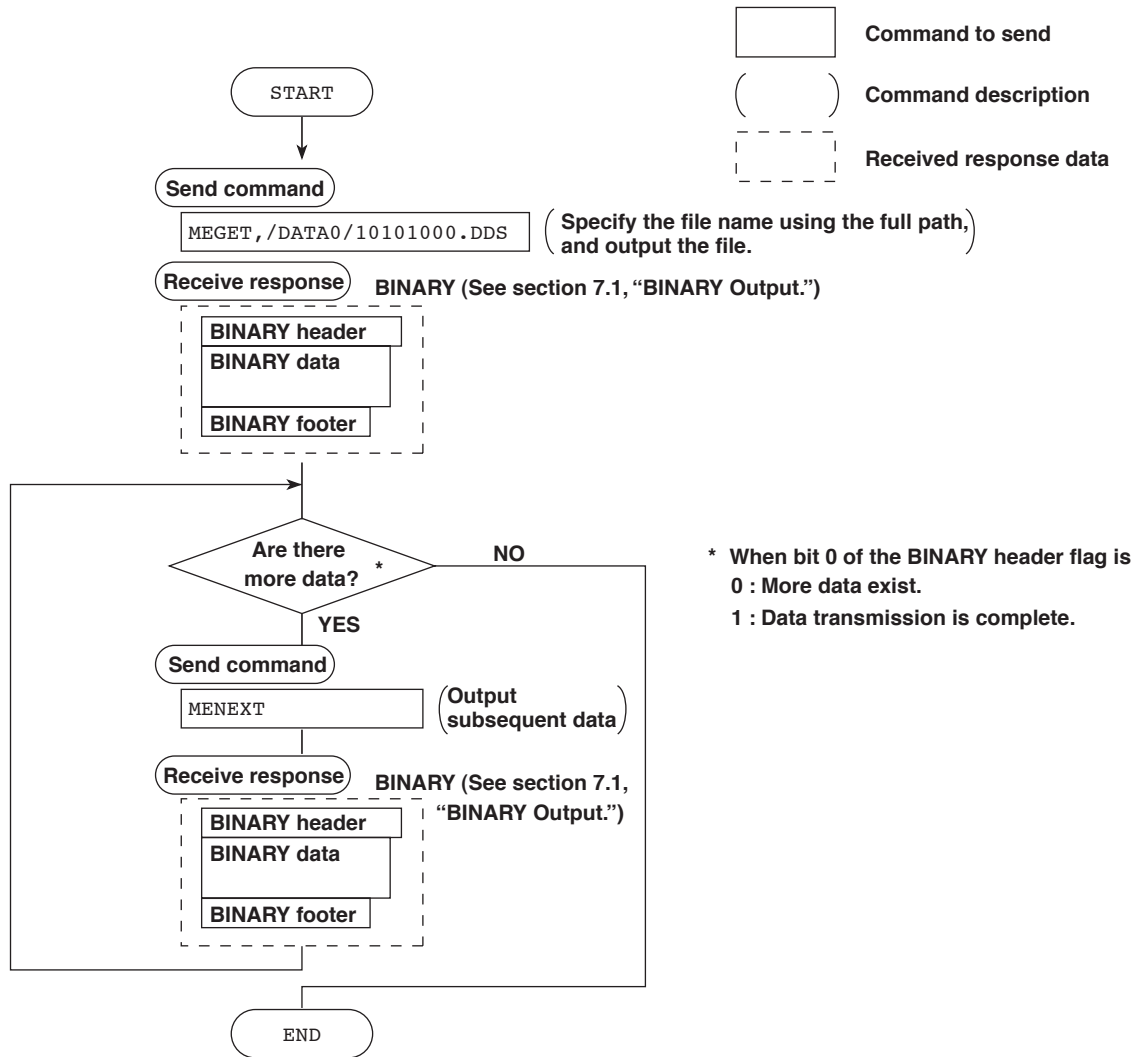

Example in Which the File List Belonging to Directory DATA0 Is Output 10 Files at a Time

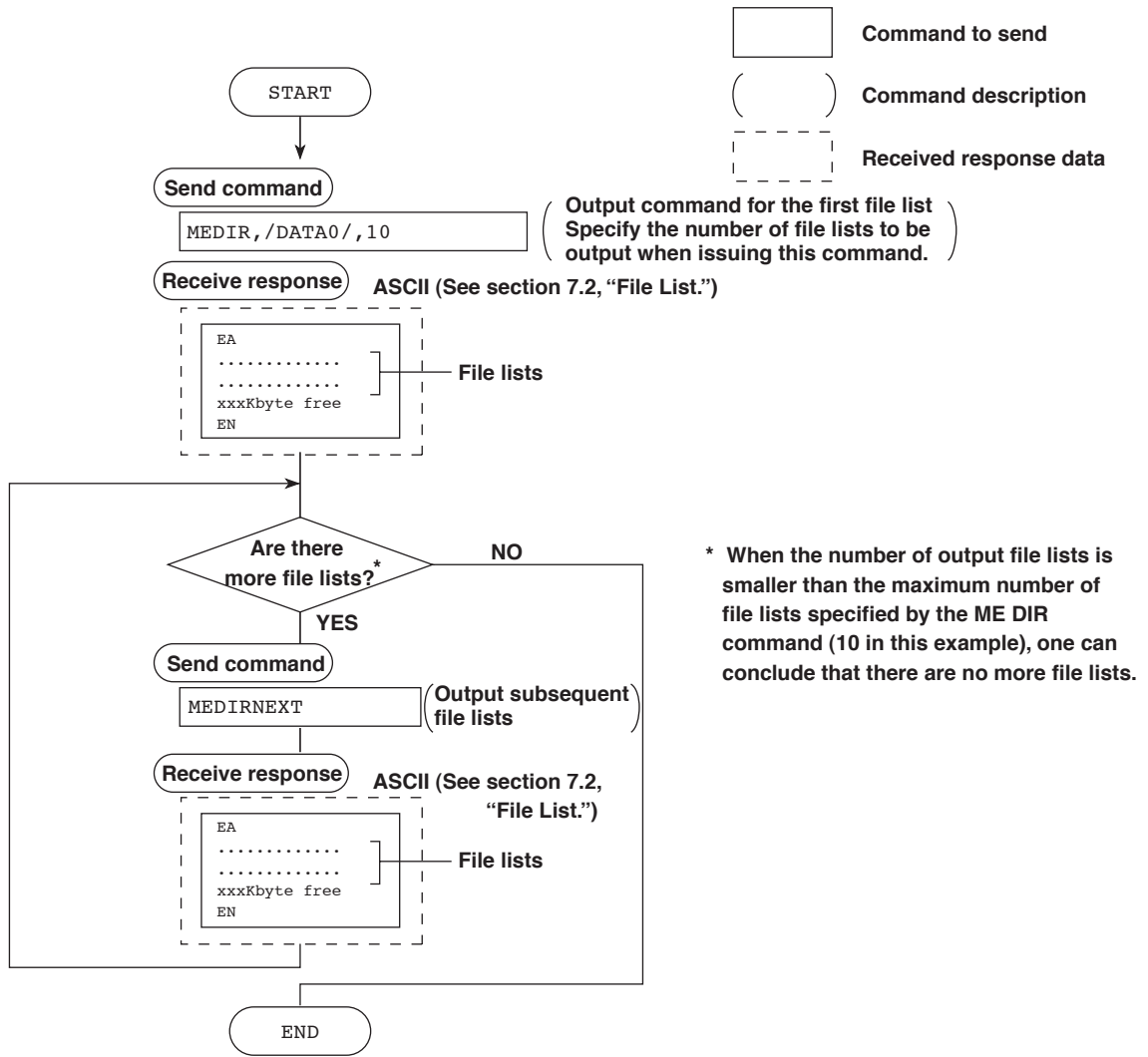

Appendix 4 Output Flow of FIFO Data

Overview of the FIFO Buffer

The CX has a dedicated internal memory for outputting measured/computed/control data. The memory structure is FIFO (First-In-First-Out). Measured/computed/control data is constantly acquired to the internal memory at the specified acquisition interval (FIFO acquisition interval, set with the FR command). By using this function, it is possible to read measured/computed/control data that has been saved at specified intervals regardless of the frequency at which the PC periodically reads the measured/computed/control data.

The following example shows the case when the acquisition interval is 1 s and the capacity of the FIFO memory is for 8 intervals.

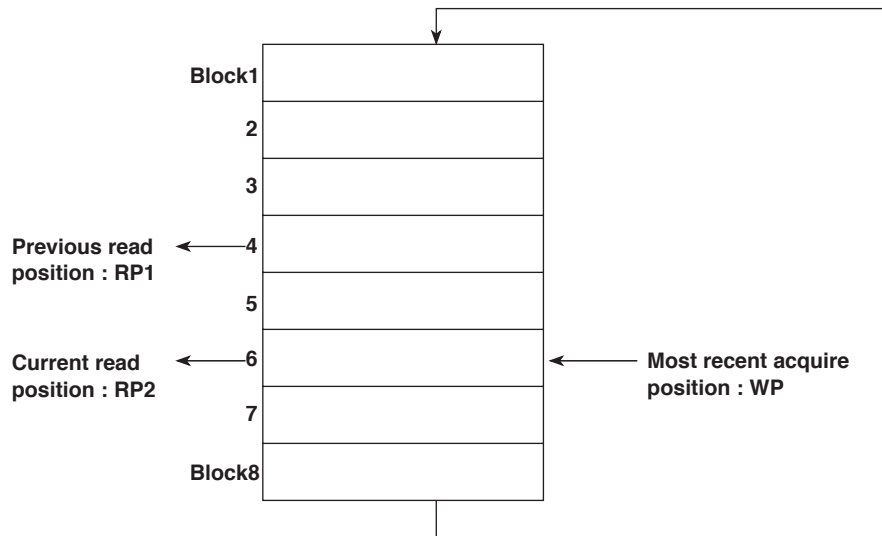

Acquiring measured/computed/control data

- The measured/computed/control data is acquired to the internal memory at an interval of 1 s.
- Measured/computed/control data is acquired to positions 1 through 8 in order. After acquiring to position 8, the next data is acquired to position 1.

Reading the measured/computed/control data (FF GET command is used).

Logging output)

Outputs the data from the previous read position (RP1) to the most recent acquisition position (WP).

In this example, more than 2 s has elapsed from the previous read operation. Therefore, data in positions 5 and 6 is output.

Reading the measured/computed/control data (FF GETNEW command is used).

Logging output)

Outputs the data from the most recent acquisition position (WP) back to the specified number of blocks.

If the number of block is set to 5 in this example, data of blocks 2 to 6 is output.

The size of internal memory allocated for the FIFO buffer (FIFO buffer data length) is equal to the size for acquiring 60 intervals (60 s total for a scan interval of 1 s).

Example in Which the FIFO Acquisition Interval on the CX Is Set to 1 s and the Measured/Computed/Control Data from CH1 to CH248 Is Continuously Output using the FIFO Function (Logging)

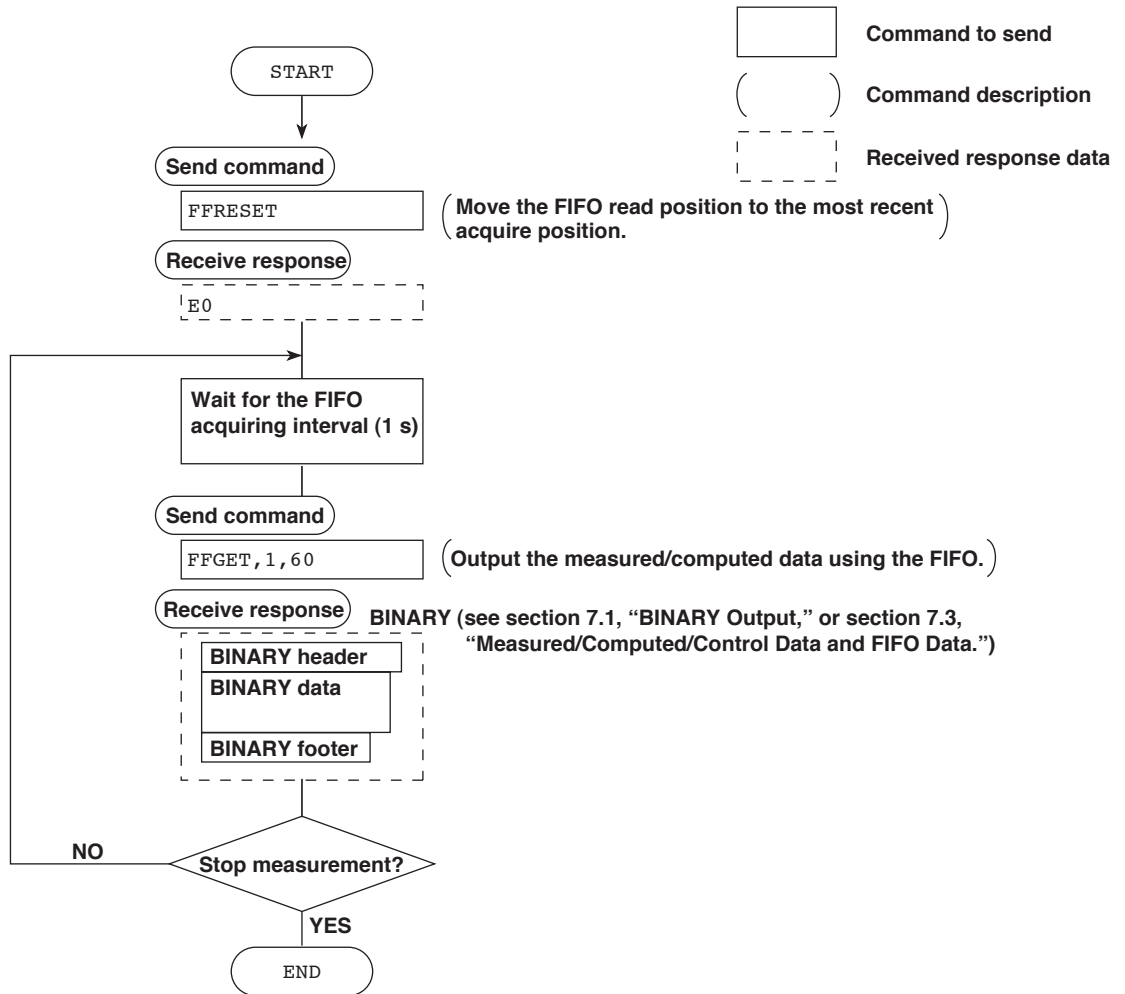

Note

- The FIFO acquisition interval must be set using the FR command beforehand.
- The FIFO acquisition interval applies to both serial and Ethernet communications.

Appendix 5 Data Dropout during Modbus Master

If the response to the previous command is not complete when the CX attempts to issue a command to a slave device, the CX command cannot issue the command, and a data dropout results. Take appropriate measures by referring to the following figures.

1. When the response from the slave device take a long time

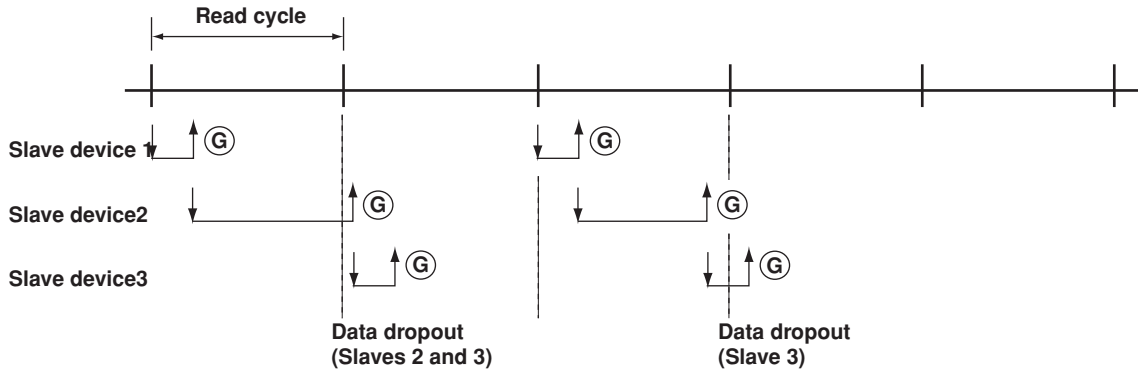

2. When there is no response from the slave device

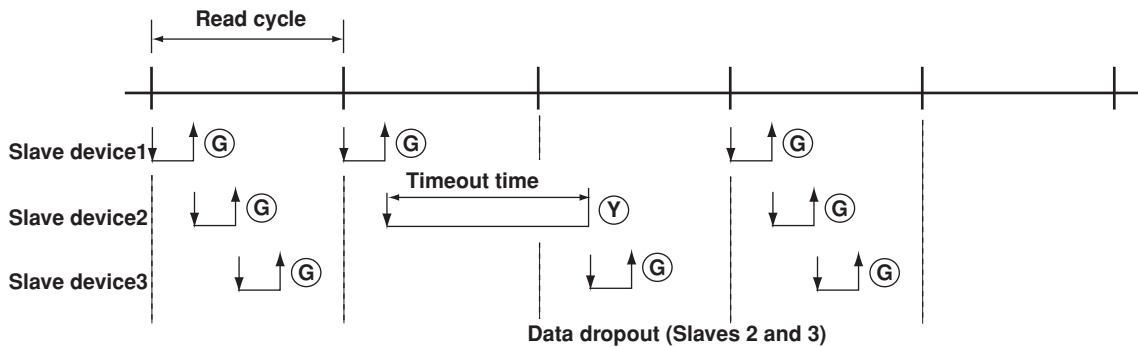

3. When the slave device that does not respond is cut off (with number of retrials set to 1)

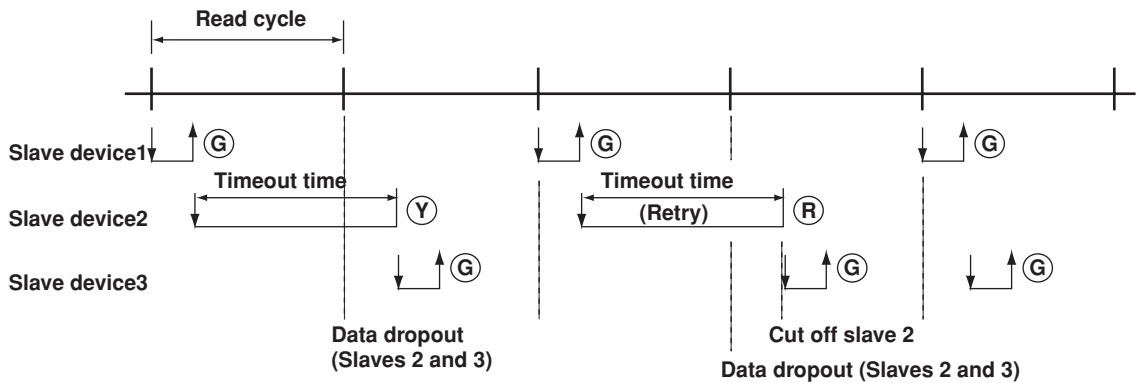

ⓐ ⓑ Ⓒ : Status lamp

↓ : Command from the CX

↑ : Response from the slave device

Appendix 6 Register Assignments

Register Assignments during Modbus Slave

The register assignments of the Modbus slave function are shown below. On the CX1000, if you write to or read from a register that does not exist (communication registers C13 to C30, measurement channels 07 to 20, computation channels 43 to 60, and control loops 3 to 6), an error (error code 2) is returned.

• Hold Registers

Modbus Register Number	Description	Value	Read/Write
40001-40030	Communication register data	-32768 to 32767	R/W
40101	Control operation start/stop of all loops	0: Stop 1: Start	W*1
40301	Memory start/stop	0: Memory stop 1: Memory start	R/W
40302	Alarm ACK	When writing 0: Execute alarm ACK When reading 0: Alarm not illuminated 1: Alarm illuminated 2: Alarm blinking	R/W
40303	Computation start/stop	0: Stop computation 1: Start computation 2: Reset computation	R/W
40304	Save the manual trigger, manual sampled, snapshot, display data to the external storage medium/saves the event data to the external storage medium	0: Execute manual sampling 1: Activate manual trigger 2: Snapshot 3: Save display data to the external storage medium 4: Save event data to the external storage medium	W*1
40305	Write message	1 to 8: Message number	W*1
40306	Revert to the operation display	0: Set the display back to the operation display	W*1
40501	Alarm value of measurement channel 1 (Alarm number 1)	Value within the measurement span excluding the decimal point (see the SA command)	R/W
40502	Alarm value of measurement channel 1 (Alarm number 2)	Value within the measurement span excluding the decimal point (see the SA command)	R/W
40503	Alarm value of measurement channel 1 (Alarm number 3)	Value within the measurement span excluding the decimal point (see the SA command)	R/W
40504	Alarm value of measurement channel 1 (Alarm number 4)	Value within the measurement span excluding the decimal point (see the SA command)	R/W
:	:	:	:
40577	Alarm value of measurement channel 20 (Alarm number 1)	Value within the measurement span excluding the decimal point (see the SA command)	R/W
40578	Alarm value of measurement channel 20 (Alarm number 2)	Value within the measurement span excluding the decimal point (see the SA command)	R/W
40579	Alarm value of measurement channel 20 (Alarm number 3)	Value within the measurement span excluding the decimal point (see the SA command)	R/W
40580	Alarm value of measurement channel 20 (Alarm number 4)	Value within the measurement span excluding the decimal point (see the SA command)	R/W

*1 If a write-only register in the hold registers is read, a "0" is returned.

Appendix 6 Register Assignments

Modbus Register Number	Description	Value	Read/Write
40601	Alarm value of computation channel 1 Higher 2 bytes of alarm number 1	Value, obtained by combining the higher 2 bytes and lower 2 bytes, within the computation channel span excluding the decimal point (see the SA command)	R/W
40602	Alarm value of computation channel 1 Lower 2 bytes of alarm number 1		R/W
40603	Alarm value of computation channel 1 Higher 2 bytes of alarm number 2	Value, obtained by combining the higher 2 bytes and lower 2 bytes, within the computation channel span excluding the decimal point (see the SA command)	R/W
40604	Alarm value of computation channel 1 Lower 2 bytes of alarm number 2		R/W
40605	Alarm value of computation channel 1 Higher 2 bytes of alarm number 3	Value, obtained by combining the higher 2 bytes and lower 2 bytes, within the computation channel span excluding the decimal point (see the SA command)	R/W
40606	Alarm value of computation channel 1 Lower 2 bytes of alarm number 3		R/W
40607	Alarm value of computation channel 1 Higher 2 bytes of alarm number 4	Value, obtained by combining the higher 2 bytes and lower 2 bytes, within the computation channel span excluding the decimal point (see the SA command)	R/W
40608	Alarm value of computation channel 1 Lower 2 bytes of alarm number 4		R/W
:	:	:	:
40833	Alarm value of computation channel 60 Higher 2 bytes of alarm number 1	Value, obtained by combining the higher 2 bytes and lower 2 bytes, within the computation channel span excluding the decimal point (see the SA command)	R/W
40834	Alarm value of computation channel 60 Lower 2 bytes of alarm number 1		R/W
40835	Alarm value of computation channel 60 Higher 2 bytes of alarm number 2	Value, obtained by combining the higher 2 bytes and lower 2 bytes, within the computation channel span excluding the decimal point (see the SA command)	R/W
40836	Alarm value of computation channel 60 Lower 2 bytes of alarm number 2		R/W
40837	Alarm value of computation channel 60 Higher 2 bytes of alarm number 3	Value, obtained by combining the higher 2 bytes and lower 2 bytes, within the computation channel span excluding the decimal point (see the SA command)	R/W
40838	Alarm value of computation channel 60 Lower 2 bytes of alarm number 3		R/W
40839	Alarm value of computation channel 60 Higher 2 bytes of alarm number 4	Value, obtained by combining the higher 2 bytes and lower 2 bytes, within the computation channel span excluding the decimal point (see the SA command)	R/W
40840	Alarm value of computation channel 60 Lower 2 bytes of alarm number 4		R/W

If a multiple write command of function code 16 is sent to the CX and the write operation to the register by the CX fails, the write operation is stopped and error code 7 is returned. When writing an alarm value to a computation channel, the two registers of higher 2 bytes and lower 2 bytes must be written simultaneously using the multiple register write of function code 16. If you attempt to write only the higher 2 bytes or lower 2 bytes, error code 7 is returned.

Parameters Related to Loop 1

Modbus Register Number	Register Type	Description	Value	Read/Write
41001	Parameter per Loop	Enable/Disable the use of bias on PV1, bias value, bias input type	-100% to 100% of the measurement span: Bias value (bias enabled) -30001 to -32768, 30001 to 32767: Bias disabled	R/W
41002		Enable/Disable the use of bias on PV2, bias value, bias input type	-100% to 100% of the measurement span: Bias value (bias enabled) -30001 to -32768, 30001 to 32767: Bias disabled	R/W
41003		Enable/Disable the use of bias on RemoteSP, bias value	-100% to 100% of the measurement span: Bias value (bias enabled) -30001 to -32768, 30001 to 32767: Bias disabled	R/W
41004		Type of filter used on PV1, enable/disable the use of the filter, filter value	1 to 120: Filter value (filter enabled) -30001 to -32768, 30001 to 32767: Filter disabled	R/W
41005		Type of filter used on PV2, enable/disable the use of the filter, filter value	1 to 120: Filter value (filter enabled) -30001 to -32768, 30001 to 32767: Filter disabled	R/W
41006		Type of filter used on RemoteSP, enable/disable the use of the filter, filter value	1 to 120: Filter value (filter enabled) -30001 to -32768, 30001 to 32767: Filter disabled	R/W
41007		Enable/Disable ratio setting and the ratio value	1 to 9999: Ratio value (ratio setting enabled) -30001 to -32768, 30001 to 32767: Ratio setting disabled	R/W
41008		Suppressing function On/Off	0: Suppressing function OFF 1: Suppressing function ON	R/W
41009		Ramp-rate-time unit	0: Hour 2: Second 1: Minute	R/W
41010		SP ramp-up-rate	Value between 1 and the maximum value of the measurement span excluding the decimal point. -30001 to -32768, 30001 to 32767: OFF	R/W
41011	SP ramp-down-rate	Value between 1 and the maximum value of the measurement span excluding the decimal point. -30001 to -32768, 30001 to 32767: OFF	R/W	
41012	Switch between auto, manual, and cascade control	0: Auto switching 1: Manual switching 2: Cascade switching (valid only during cascade control)	R/W	
41013	Target setpoint number	1 to 8: SP number	R/W	
41014	Switch run/stop	0: Stop 1: Start	R/W	
41015	Remote/local switching	0: Local 1: Remote	R/W	
41016	Currently used PID number	1 to 8: PID number	R	
41017	OUT value in manual mode	-50 to 1050: -5.0% to 105.0%	R/W	
41018	Auto tuning (AT) status	0: AT not in progress 1: AT in progress	R	
41019	Decimal point position of the ratio value	0 to 4	R	

Appendix 6 Register Assignments

Modbus Register Number	Register Type	Description	Value	Read/Write
41101	PID parameters of PID number 1 of loop 1	Target setpoint (SP)	Within the measurement span excluding the decimal point	R/W
41102		Proportional band (P)	1 to 9999: 0.1 to 999.9%	R/W
41103		Integral time (I)	0 to 6000	R/W
41104		Derivative time (D)	0 to 6000	R/W
41105		Output low-limit	-50 to 1050: -5.0% to 105.0%	R/W
41106		Output high-limit	-50 to 1050: -5.0% to 105.0%	R/W
41107		Shutdown function enable/disable	0: OFF 1: ON	R/W
41108		Manual reset	-50 to 1050: -5.0% to 105.0%	R/W
41109		Hysteresis value	Within the measurement span excluding the decimal point	R/W
41110		Hysteresis activation point	0: OFF 1: Upper 2: Lower	R/W
41111		Control action direction switching	0: Reverse 1: Direct	R/W
41112			Preset output	-50 to 1050: -5.0% to 105.0%
41125	Control alarm values of PID number 1 of loop 1	Sets the control alarm value (Alarm number 1)	Varies depending on the alarm type as follows: SP/PV alarm Within the measurement span excluding the decimal point Deviation alarm (high-limit and low-limit) Within EUS -100.0 to 100.0% of the measurement span excluding the decimal point Deviation alarm (high & low limit and within high & low limits) Within EUS 0.0 to -100.0% of the measurement span excluding the decimal point Output alarm -50 to 1050: -5.0% to 105.0% (See the AV command)	R/W
41126		Control alarm value (Alarm number 2)	Same as above	R/W
41127		Control alarm value (Alarm number 3)	Same as above	R/W
41128		Control alarm value (Alarm number 4)	Same as above	R/W
41131-41142	PID parameters of PID number 2 of loop 1	Same as the PID parameters of PID number 1 of loop 1	Same as the range for the PID parameters of PID number 1 of loop 1	R/W
41155-41158	Control alarm values of PID number 2 of loop 1	Same as the control alarm values of PID number 1 of loop 1	Same as the range for the control alarm values of PID number 1 of loop 1	R/W
41161-41172	PID parameters of PID number 3 of loop 1	Same as the PID parameters of PID number 1 of loop 1	Same as the range for the PID parameters of PID number 1 of loop 1	R/W

Modbus Register Number	Register Type	Description	Value	Read/Write
41185-41188	Control alarm value of PID number 3 of loop 1	Same as the control alarm values of PID number 1 of loop 1	Same as the range for the control alarm values of PID number 1 of loop 1	R/W
41191-41202	PID parameter of PID number 4 of loop 1	Same as the PID parameters of PID number 1 of loop 1	Same as the range for the PID parameters of PID number 1 of loop 1	R/W
41215-41218	Control alarm value of PID number 4 of loop 1	Same as the control alarm values of PID number 1 of loop 1	Same as the range for the control alarm values of PID number 1 of loop 1	R/W
41221-41232	PID parameter of PID number 5 of loop 1	Same as the PID parameters of PID number 1 of loop 1	Same as the range for the PID parameters of PID number 1 of loop 1	R/W
41245-41248	Control alarm value of PID number 5 of loop 1	Same as the control alarm values of PID number 1 of loop 1	Same as the range for the control alarm values of PID number 1 of loop 1	R/W
41251-41262	PID parameter of PID number 6 of loop 1	Same as the PID parameters of PID number 1 of loop 1	Same as the range for the PID parameters of PID number 1 of loop 1	R/W
41275-41278	Control alarm value of PID number 6 of loop 1	Same as the control alarm values of PID number 1 of loop 1	Same as the range for the control alarm values of PID number 1 of loop 1	R/W
41281-41292	PID parameter of PID number 7 of loop 1	Same as the PID parameters of PID number 1 of loop 1	Same as the range for the PID parameters of PID number 1 of loop 1	R/W
41305-41308	Control alarm value of PID number 7 of loop 1	Same as the control alarm values of PID number 1 of loop 1	Same as the range for the control alarm values of PID number 1 of loop 1	R/W
41311-41322	PID parameter of PID number 8 of loop 1	Same as the PID parameters of PID number 1 of loop 1	Same as the range for the PID parameters of PID number 1 of loop 1	R/W
41335-41338	Control alarm value of PID number 8 of loop 1	Same as the control alarm values of PID number 1 of loop 1	Same as the range for the control alarm values of PID number 1 of loop 1	R/W

Appendix 6 Register Assignments

Parameters Related to Loop 2

Modbus Register Number	Register Type	Description	Value	Read/Write
41501-41519	Parameter per Loop	Same as the parameters for loop 1	Same as the range for the parameters for loop 1	R/W
41601-41612	PID parameter of PID number 1 of loop 2	Same as the PID parameters of PID number 1 of loop 1	Same as the range for the PID parameters of PID number 1 of loop 1	R/W
41625-41628	Control alarm value of PID number 1 of loop 2	Same as the control alarm values of PID number 1 of loop 1	Same as the range for the control alarm values of PID number 1 of loop 1	R/W
41631-41642	PID parameter of PID number 2 of loop 2	Same as the PID parameters of PID number 1 of loop 1	Same as the range for the PID parameters of PID number 1 of loop 1	R/W
41655-41658	Control alarm value of PID number 2 of loop 2	Same as the control alarm values of PID number 1 of loop 1	Same as the range for the control alarm values of PID number 1 of loop 1	R/W
41661-41672	PID parameter of PID number 3 of loop 2	Same as the PID parameters of PID number 1 of loop 1	Same as the range for the PID parameters of PID number 1 of loop 1	R/W
41685-41688	Control alarm value of PID number 3 of loop 2	Same as the control alarm values of PID number 1 of loop 1	Same as the range for the control alarm values of PID number 1 of loop 1	R/W
41691-41702	PID parameter of PID number 4 of loop 2	Same as the PID parameters of PID number 1 of loop 1	Same as the range for the PID parameters of PID number 1 of loop 1	R/W
41715-41718	Control alarm value of PID number 4 of loop 2	Same as the control alarm values of PID number 1 of loop 1	Same as the range for the control alarm values of PID number 1 of loop 1	R/W
41721-41732	PID parameter of PID number 5 of loop 2	Same as the PID parameters of PID number 1 of loop 1	Same as the range for the PID parameters of PID number 1 of loop 1	R/W
41745-41748	Control alarm value of PID number 5 of loop 2	Same as the control alarm values of PID number 1 of loop 1	Same as the range for the control alarm values of PID number 1 of loop 1	R/W
41751-41762	PID parameter of PID number 6 of loop 2	Same as the PID parameters of PID number 1 of loop 1	Same as the range for the PID parameters of PID number 1 of loop 1	R/W
41775-41778	Control alarm value of PID number 6 of loop 2	Same as the control alarm values of PID number 1 of loop 1	Same as the range for the control alarm values of PID number 1 of loop 1	R/W
41781-41792	PID parameter of PID number 7 of loop 2	Same as the PID parameters of PID number 1 of loop 1	Same as the range for the PID parameters of PID number 1 of loop 1	R/W
41805-41808	Control alarm value of PID number 7 of loop 2	Same as the control alarm values of PID number 1 of loop 1	Same as the range for the control alarm values of PID number 1 of loop 1	R/W
41811-41822	PID parameter of PID number 8 of loop 2	Same as the PID parameters of PID number 1 of loop 1	Same as the range for the PID parameters of PID number 1 of loop 1	R/W
41835-41838	Control alarm value of PID number 8 of loop 2	Same as the control alarm values of PID number 1 of loop 1	Same as the range for the control alarm values of PID number 1 of loop 1	R/W

Parameters Related to Loop 3

Modbus Register Number	Register Type	Description	Value	Read/Write
42001-42019	Parameter per Loop	Same as the parameters for loop 1	Same as the range for the parameters for loop 1	R/W
42101-42112	PID parameter of PID number 1 of loop 3	Same as the PID parameters of PID number 1 of loop 1	Same as the range for the PID parameters of PID number 1 of loop 1	R/W
42125-42128	Control alarm value of PID number 1 of loop 3	Same as the control alarm values of PID number 1 of loop 1	Same as the range for the control alarm values of PID number 1 of loop 1	R/W
42131-42142	PID parameter of PID number 2 of loop 3	Same as the PID parameters of PID number 1 of loop 1	Same as the range for the PID parameters of PID number 1 of loop 1	R/W
42155-42158	Control alarm value of PID number 2 of loop 3	Same as the control alarm values of PID number 1 of loop 1	Same as the range for the control alarm values of PID number 1 of loop 1	R/W
42161-42172	PID parameter of PID number 3 of loop 3	Same as the PID parameters of PID number 1 of loop 1	Same as the range for the PID parameters of PID number 1 of loop 1	R/W
42185-42188	Control alarm value of PID number 3 of loop 3	Same as the control alarm values of PID number 1 of loop 1	Same as the range for the control alarm values of PID number 1 of loop 1	R/W
42191-42202	PID parameter of PID number 4 of loop 3	Same as the PID parameters of PID number 1 of loop 1	Same as the range for the PID parameters of PID number 1 of loop 1	R/W
42215-42218	Control alarm value of PID number 4 of loop 3	Same as the control alarm values of PID number 1 of loop 1	Same as the range for the control alarm values of PID number 1 of loop 1	R/W
42221-42232	PID parameter of PID number 5 of loop 3	Same as the PID parameters of PID number 1 of loop 1	Same as the range for the PID parameters of PID number 1 of loop 1	R/W
42245-42248	Control alarm value of PID number 5 of loop 3	Same as the control alarm values of PID number 1 of loop 1	Same as the range for the control alarm values of PID number 1 of loop 1	R/W
42251-42262	PID parameter of PID number 6 of loop 3	Same as the PID parameters of PID number 1 of loop 1	Same as the range for the PID parameters of PID number 1 of loop 1	R/W
42275-42278	Control alarm value of PID number 6 of loop 3	Same as the control alarm values of PID number 1 of loop 1	Same as the range for the control alarm values of PID number 1 of loop 1	R/W
42281-42292	PID parameter of PID number 7 of loop 3	Same as the PID parameters of PID number 1 of loop 1	Same as the range for the PID parameters of PID number 1 of loop 1	R/W
42305-42308	Control alarm value of PID number 7 of loop 3	Same as the control alarm values of PID number 1 of loop 1	Same as the range for the control alarm values of PID number 1 of loop 1	R/W
42311-42322	PID parameter of PID number 8 of loop 3	Same as the PID parameters of PID number 1 of loop 1	Same as the range for the PID parameters of PID number 1 of loop 1	R/W
42335-42338	Control alarm value of PID number 8 of loop 3	Same as the control alarm values of PID number 1 of loop 1	Same as the range for the control alarm values of PID number 1 of loop 1	R/W

Appendix 6 Register Assignments

Parameters Related to Loop 4

Modbus Register Number	Register Type	Description	Value	Read/Write
42501-42519	Parameter per Loop	Same as the parameters for loop 1	Same as the range for the parameters for loop 1	R/W
42601-42612	PID parameter of PID number 1 of loop 4	Same as the PID parameters of PID number 1 of loop 1	Same as the range for the PID parameters of PID number 1 of loop 1	R/W
42625-42628	Control alarm value of PID number 1 of loop 4	Same as the control alarm values of PID number 1 of loop 1	Same as the range for the control alarm values of PID number 1 of loop 1	R/W
42631-42642	PID parameter of PID number 2 of loop 4	Same as the PID parameters of PID number 1 of loop 1	Same as the range for the PID parameters of PID number 1 of loop 1	R/W
42655-42658	Control alarm value of PID number 2 of loop 4	Same as the control alarm values of PID number 1 of loop 1	Same as the range for the control alarm values of PID number 1 of loop 1	R/W
42661-42672	PID parameter of PID number 3 of loop 4	Same as the PID parameters of PID number 1 of loop 1	Same as the range for the PID parameters of PID number 1 of loop 1	R/W
42685-42688	Control alarm value of PID number 3 of loop 4	Same as the control alarm values of PID number 1 of loop 1	Same as the range for the control alarm values of PID number 1 of loop 1	R/W
42691-42702	PID parameter of PID number 4 of loop 4	Same as the PID parameters of PID number 1 of loop 1	Same as the range for the PID parameters of PID number 1 of loop 1	R/W
42715-42718	Control alarm value of PID number 4 of loop 4	Same as the control alarm values of PID number 1 of loop 1	Same as the range for the control alarm values of PID number 1 of loop 1	R/W
42721-42732	PID parameter of PID number 5 of loop 4	Same as the PID parameters of PID number 1 of loop 1	Same as the range for the PID parameters of PID number 1 of loop 1	R/W
42745-42748	Control alarm value of PID number 5 of loop 4	Same as the control alarm values of PID number 1 of loop 1	Same as the range for the control alarm values of PID number 1 of loop 1	R/W
42751-42762	PID parameter of PID number 6 of loop 4	Same as the PID parameters of PID number 1 of loop 1	Same as the range for the PID parameters of PID number 1 of loop 1	R/W
42775-42778	Control alarm value of PID number 6 of loop 4	Same as the control alarm values of PID number 1 of loop 1	Same as the range for the control alarm values of PID number 1 of loop 1	R/W
42781-42792	PID parameter of PID number 7 of loop 4	Same as the PID parameters of PID number 1 of loop 1	Same as the range for the PID parameters of PID number 1 of loop 1	R/W
42805-42808	Control alarm value of PID number 7 of loop 4	Same as the control alarm values of PID number 1 of loop 1	Same as the range for the control alarm values of PID number 1 of loop 1	R/W
42811-42822	PID parameter of PID number 8 of loop 4	Same as the PID parameters of PID number 1 of loop 1	Same as the range for the PID parameters of PID number 1 of loop 1	R/W
42835-42838	Control alarm value of PID number 8 of loop 4	Same as the control alarm values of PID number 1 of loop 1	Same as the range for the control alarm values of PID number 1 of loop 1	R/W

Parameters Related to Loop 5

Modbus Register Number	Register Type	Description	Value	Read/Write
43001-43019	Parameter per Loop	Same as the parameters for loop 1 ^{*2}	Same as the range for the parameters for loop 1	R/W
43101-43112	PID parameter of PID number 1 of loop 5	Same as the PID parameters of PID number 1 of loop 1	Same as the range for the PID parameters of PID number 1 of loop 1	R/W
43125-43128	Control alarm value of PID number 1 of loop 5	Same as the control alarm values of PID number 1 of loop 1	Same as the range for the control alarm values of PID number 1 of loop 1	R/W
43131-43142	PID parameter of PID number 2 of loop 5	Same as the PID parameters of PID number 1 of loop 1	Same as the range for the PID parameters of PID number 1 of loop 1	R/W
43155-43158	Control alarm value of PID number 2 of loop 5	Same as the control alarm values of PID number 1 of loop 1	Same as the range for the control alarm values of PID number 1 of loop 1	R/W
43161-43172	PID parameter of PID number 3 of loop 5	Same as the PID parameters of PID number 1 of loop 1	Same as the range for the PID parameters of PID number 1 of loop 1	R/W
43185-43188	Control alarm value of PID number 3 of loop 5	Same as the control alarm values of PID number 1 of loop 1	Same as the range for the control alarm values of PID number 1 of loop 1	R/W
43191-43202	PID parameter of PID number 4 of loop 5	Same as the PID parameters of PID number 1 of loop 1	Same as the range for the PID parameters of PID number 1 of loop 1	R/W
43215-43218	Control alarm value of PID number 4 of loop 5	Same as the control alarm values of PID number 1 of loop 1	Same as the range for the control alarm values of PID number 1 of loop 1	R/W
43221-43232	PID parameter of PID number 5 of loop 5	Same as the PID parameters of PID number 1 of loop 1	Same as the range for the PID parameters of PID number 1 of loop 1	R/W
43245-43248	Control alarm value of PID number 5 of loop 5	Same as the control alarm values of PID number 1 of loop 1	Same as the range for the control alarm values of PID number 1 of loop 1	R/W
43251-43262	PID parameter of PID number 6 of loop 5	Same as the PID parameters of PID number 1 of loop 1	Same as the range for the PID parameters of PID number 1 of loop 1	R/W
43275-43278	Control alarm value of PID number 6 of loop 5	Same as the control alarm values of PID number 1 of loop 1	Same as the range for the control alarm values of PID number 1 of loop 1	R/W
43281-43292	PID parameter of PID number 7 of loop 5	Same as the PID parameters of PID number 1 of loop 1	Same as the range for the PID parameters of PID number 1 of loop 1	R/W
43305-43308	Control alarm value of PID number 7 of loop 5	Same as the control alarm values of PID number 1 of loop 1	Same as the range for the control alarm values of PID number 1 of loop 1	R/W
43311-43322	PID parameter of PID number 8 of loop 5	Same as the PID parameters of PID number 1 of loop 1	Same as the range for the PID parameters of PID number 1 of loop 1	R/W
43335-43338	Control alarm value of PID number 8 of loop 5	Same as the control alarm values of PID number 1 of loop 1	Same as the range for the control alarm values of PID number 1 of loop 1	R/W

*2 Loops 5 and 6 do not have Remote, bias setting against PV range, filter setting, ratio setting, and remote/local switching.

Appendix 6 Register Assignments

Parameters Related to Loop 6

Modbus Register Number	Register Type	Description	Value	Read/Write
43501-43519	Parameter per Loop	Same as the parameters for loop 1 ^{*2}	Same as the range for the parameters for loop 1	R/W
43601-43612	PID parameter of PID number 1 of loop 6	Same as the PID parameters of PID number 1 of loop 1	Same as the range for the PID parameters of PID number 1 of loop 1	R/W
43625-43628	Control alarm value of PID number 1 of loop 6	Same as the control alarm values of PID number 1 of loop 1	Same as the range for the control alarm values of PID number 1 of loop 1	R/W
43631-43642	PID parameter of PID number 2 of loop 6	Same as the PID parameters of PID number 1 of loop 1	Same as the range for the PID parameters of PID number 1 of loop 1	R/W
43655-43658	Control alarm value of PID number 2 of loop 6	Same as the control alarm values of PID number 1 of loop 1	Same as the range for the control alarm values of PID number 1 of loop 1	R/W
43661-43672	PID parameter of PID number 3 of loop 6	Same as the PID parameters of PID number 1 of loop 1	Same as the range for the PID parameters of PID number 1 of loop 1	R/W
43685-43688	Control alarm value of PID number 3 of loop 6	Same as the control alarm values of PID number 1 of loop 1	Same as the range for the control alarm values of PID number 1 of loop 1	R/W
43691-43702	PID parameter of PID number 4 of loop 6	Same as the PID parameters of PID number 1 of loop 1	Same as the range for the PID parameters of PID number 1 of loop 1	R/W
43715-43718	Control alarm value of PID number 4 of loop 6	Same as the control alarm values of PID number 1 of loop 1	Same as the range for the control alarm values of PID number 1 of loop 1	R/W
43721-43732	PID parameter of PID number 5 of loop 6	Same as the PID parameters of PID number 1 of loop 1	Same as the range for the PID parameters of PID number 1 of loop 1	R/W
43745-43748	Control alarm value of PID number 5 of loop 6	Same as the control alarm values of PID number 1 of loop 1	Same as the range for the control alarm values of PID number 1 of loop 1	R/W
43751-43762	PID parameter of PID number 6 of loop 6	Same as the PID parameters of PID number 1 of loop 1	Same as the range for the PID parameters of PID number 1 of loop 1	R/W
43775-43778	Control alarm value of PID number 6 of loop 6	Same as the control alarm values of PID number 1 of loop 1	Same as the range for the control alarm values of PID number 1 of loop 1	R/W
43781-43792	PID parameter of PID number 7 of loop 6	Same as the PID parameters of PID number 1 of loop 1	Same as the range for the PID parameters of PID number 1 of loop 1	R/W
43805-43808	Control alarm value of PID number 7 of loop 6	Same as the control alarm values of PID number 1 of loop 1	Same as the range for the control alarm values of PID number 1 of loop 1	R/W
43811-43822	PID parameter of PID number 8 of loop 6	Same as the PID parameters of PID number 1 of loop 1	Same as the range for the PID parameters of PID number 1 of loop 1	R/W
43835-43838	Control alarm value of PID number 8 of loop 6	Same as the control alarm values of PID number 1 of loop 1	Same as the range for the control alarm values of PID number 1 of loop 1	R/W

*2 Loops 5 and 6 do not have Remote, bias setting against PV range, filter setting, and remote/local switching.

• **Control Channel Bias and Filter Values When PV/SP Computation is ON**

When PV/SP computation is ON, the bias and filter values for PV1 and PV2 specified by loops is set by control channel.

Modbus Register Number	Register Type	Description	Value	Read/Write
44901		Enable/Disable the use of bias on CI01, bias value	-100% to 100% of the control input range: Bias value (bias enabled) -30001 to -32768, 30001 to 32767: Bias disabled	R/W
44902		Enable/Disable the use of bias on CI02, bias value, bias input type		
:		:		
44910		Enable/Disable the use of bias on CI10, bias value		
44911		Type of filter used on CI01, enable/disable the use of the filter, filter value	1 to 120: Filter value (filter enabled) -30001 to -32768, 30001 to 32767: Filter disabled	R/W
44912		Type of filter used on CI02, enable/disable the use of the filter, filter value		
:		:		
44920		Type of filter used on CI10, enable/disable the use of the filter, filter value		

Appendix 6 Register Assignments

• Program Control Parameters

Modbus Register Number	Register Type	Description	Value	Read/Write
44001		Program run/stop	0: Stop, 1: Run	R/W
44002		Hold program operation	0: None, 1: in HOLD	R/W
44003		Advance segment	1: Advance request	W
44004		Switch pattern number (Operated pattern number designated on this register)	1: Pattern number 1 : 30: Pattern number 30	W
44005		Pattern number in operation	1: Pattern number 1 : 30: Pattern number 30	R
44006		Segment number in operation	0-99 0 is the time between program control start and program pattern control start.	R
44007		Number of segments of the pattern used currently	1-99	R
44008		Remaining segment time of the pattern in operation (hh)	0-99 ^{*3}	R
44009		Remaining segment time of the pattern in operation (mm)	0-59 ^{*3}	R
44010		Remaining segment time of the pattern in operation (ss)	0-59 ^{*3}	R
44011		Wait mode	0: None, 1: in wait mode	R
44012		Elapsed wait time in wait mode (hh)	0-99 ^{*3}	R
44013		Elapsed wait time in wait mode (mm)	0-59 ^{*3}	R
44014		Elapsed wait time in wait mode (ss)	0-59 ^{*3}	R
44015-44020		Reserved	0	R
44021		Repeat setting of the current pattern	0: OFF 1: ON 2: Repeat infinite number of times	R
44022		Repeat frequency of the pattern in operation	0-999	R
44023		Remaining repeat frequency of the pattern in operation	0-999	R
44024		Repeat start number of the pattern in operation	1-99	R
44025		Repeat end number of the pattern in operation	1-99	R
44026-44030		Reserved	0	R
44031		Program control end signal	0: None, 1: Program control end	R
44032		PV event status	^{*4}	R
44033		Time event status	^{*4}	R

*3 To read the remaining segment time and the elapsed wait time (hh:mm:ss), read three registers.

*4 Each register bit (16 bits) indicates the event status corresponding to each event number. When the setting is "1," the event is ON.

Bit	Event number	Bit Status and Event Status
0	1	0: Event OFF, 1: Event ON
1	2	0: Event OFF, 1: Event ON
2	3	0: Event OFF, 1: Event ON
3	4	0: Event OFF, 1: Event ON
4	5	0: Event OFF, 1: Event ON
5	6	0: Event OFF, 1: Event ON
6	7	0: Event OFF, 1: Event ON
7	8	0: Event OFF, 1: Event ON
8	9	0: Event OFF, 1: Event ON
9	10	0: Event OFF, 1: Event ON
10	11	0: Event OFF, 1: Event ON
11	12	0: Event OFF, 1: Event ON
12	13	0: Event OFF, 1: Event ON
13	14	0: Event OFF, 1: Event ON
14	15	0: Event OFF, 1: Event ON
15	16	0: Event OFF, 1: Event ON

Appendix 6 Register Assignments

• Program Individual Control Parameters

Modbus Register Number	Register Type	Description	Value	Read/Write
38101		Pattern number used as pattern id1	1: Pattern number 1 : 30: Pattern number 30	R
38102		Pattern number used as pattern id2	1: Pattern number 1 : 30: Pattern number 30	R
38103		Pattern number used as pattern id3	1: Pattern number 1 : 30: Pattern number 30	R
38104		Pattern number used as pattern id4	1: Pattern number 1 : 30: Pattern number 30	R
38105		Pattern number used as pattern id5	1: Pattern number 1 : 30: Pattern number 30	R
38106		Pattern number used as pattern id6	1: Pattern number 1 : 30: Pattern number 30	R
38107 to 38112		Run/stop programs of patterns id1–6	0: stop, 1: run	R
38113 to 38118		Run/hold programs of patterns id1–6	0: none, 1: holding	R
38119 to 38124		Segment number of executing pattern id1–6	0–99. However 0 indicates the time until the program pattern starts running after the program starts running.	R
38125 to 38130		Number of segments of pattern id1–6	1-99	R
38131		Remaining segment time (hh) of pattern id1	0-59*3	R
38132		Remaining segment time (mm) of pattern id1	0-59*3	R
38133		Remaining segment time (ss) of pattern id1	0-59*3	R
38134		Remaining segment time (hh) of pattern id2	0-59*3	R
38135		Remaining segment time (mm) of pattern id2	0-59*3	R
38136		Remaining segment time (ss) of pattern id2	0-59*3	R
:		:	:	R
38146		Remaining segment time (hh) of pattern id6	0-59*3	R
38147		Remaining segment time (mm) of pattern id6	0-59*3	R
38148		Remaining segment time (ss) of pattern id6	0-59*3	R
38149 to 38154		Wait status	0:None 1: waiting	R

Modbus Register Number	Register Type	Description	Value	Read/Write
38155		Switch time of pattern id1, and elapsed wait time (hh) when waiting.	0-59*3	R
38156		Switch time of pattern id1, and elapsed wait time (mm) when waiting.	0-59*3	R
38157		Switch time of pattern id1, and elapsed wait time (ss) when waiting.	0-59*3	R
:		:	:	
38170		Switch time of pattern id6, and elapsed wait time (hh) when waiting.	0-59*3	R
38171		Switch time of pattern id6, and elapsed wait time (mm) when waiting.	0-59*3	R
38172		Switch time of pattern id6, and elapsed wait time (ss) when waiting.	0-59*3	R
38173 to 38180		Reserved		
38181 to 38186		Repeat setting of pattern id1-6	0:OFF 1:ON 2:Unlimited repetitions	R
38187 to 38192		Repeat count of pattern id1-6	0-999. However, active only when repeat setting is 1 (ON).	R
38193 to 38198		Remaining repeat count of pattern id1-6	0-999	R
38199 to 38204		Repeat start number of pattern id1-6	1-99	R
38205 to 38210		Repeat end number of pattern id1-6	1-99	R
38211 to 38300		Reserved		
38301 to 38306		Pattern end signal of pattern id1-6	0:None 1: pattern end	R
38307 to 38312		Time event status of pattern id1-6		R
38313 to 38318		PV event status of pattern id1-6		R

Note

The relation between pattern id and pattern number is determined by reading the operating/stopped registers (38107-38112).

Appendix 6 Register Assignments

• **Write Registers for DO/internal switches**

Modbus Register Number	Register Type	Description	Value	Read/Write
44501		DO001	0: OFF, 1: ON	R/W
44502		DO002	0: OFF, 1: ON	R/W
44503		DO003	0: OFF, 1: ON	R/W
44504		DO004	0: OFF, 1: ON	R/W
44505		DO005	0: OFF, 1: ON	R/W
44506		DO006	0: OFF, 1: ON	R/W
44507 to 44512		DO101 to DO106	0: OFF, 1: ON	R/W
44513 to 44518		DO201 to DO206	0: OFF, 1: ON	R/W
44519 to 44530		RO001 to RO012	0: OFF, 1: ON	R/W
44531 to 44600		Reserved		
44601 to 44636		SW001 to SW036	0: OFF, 1: ON	R/W

• Input Registers

Modbus Register Number	Description	Data	Read/Write
30001	Measured data	Measured data of CH01	R
:	:	:	:
30020	Measured data	Measured data of CH20	R
31001	Measured data alarm status	Alarm status of measured data of CH01 ⁵	R
:	:	:	:
31020	Measured data alarm status	Alarm status of measured data of CH20 ⁵	R
32001	Computed data	Computed data of CH31 (higher 2 bytes)	R
32002	Computed data	Computed data of CH31 (lower 2 bytes)	R
:	:	:	:
32059	Computed data	Computed data of CH60 (higher 2 bytes)	R
32060	Computed data	Computed data of CH60 (lower 2 bytes)	R
33001	Computed data alarm status	Alarm status of measured data of CH31 ⁵	R
:	:	:	:
33030	Computed data alarm status	Alarm status of measured data of CH60 ⁵	R
34001	Control data	Control data of CH101	R
:	:	:	:
34018	Control data	Control data of CH118	R
35001	Control data alarm status	Alarm status of control data of CH101 ⁶ "A2A1"	R
35002	Control data alarm status	Alarm status of control data of CH101 ⁶ "A4A3"	R
:	:	:	:
35035	Control data alarm status	Alarm status of control data of CH118 ⁶ "A2A1"	R
35036	Control data alarm status	Alarm status of control data of CH118 ⁶ "A4A3"	R
36001	Measured data alarm status (CH01 to CH04)	Alarm status of alarm number 1 to 4 for CH01 to CH04 ⁷	R
:	:	:	:
36005	Measured data alarm status (CH17 to CH20)	Alarm status of alarm number 1 to 4 for CH17 to CH20 ⁷	R
36006	Computed data alarm status (CH31 to CH34)	Alarm status of alarm number 1 to 4 for CH31 to CH34 ⁷	R
:	:	:	:
36013	Computed data alarm status (CH59 and CH60)	Alarm status of alarm number 1 to 4 for CH59 and CH60 ⁷	R
36014	Control data alarm status (for loops 1 to 4)	Alarm status of alarm number 1 to 4 for loops 1 to 4 ⁸	R
36015	Control data alarm status (for loops 5 and 6)	Alarm status of alarm number 1 to 4 for loops 5 and 6 ⁸	R
37001	DI001-DI006 status	⁹	R
37002	DI101-DI106 status	⁹	R
37003	DI201-DI206 status	⁹	R
37004	RI001-RI012 status	⁹	R
37005 to 37010	Reserved		
37011	DO001-DO006 status	⁹	R
37012	DO101-DO106 status	⁹	R
37013	DO201-DO206 status	⁹	R
37014	RO001-RO012 status	⁹	R
37015 to 37020	Reserved		
37021	SW001-SW016 status	⁹	R
37022	SW017-SW032 status	⁹	R
37023	SW033-SW036 status	⁹	R
39001	Year	Year (4 digits)	R
39002	Month	1 to 12	R
39003	Day	1 to 31	R
39004	Hour	0 to 59	R
39005	Minute	0 to 59	R
39006	Second	0 to 99	R
39007	Millisecond	0 to 07 Value in units of 125 ms	R
39008	Daylight savings time	0: Winter time 1: Summer time	R

Appendix 6 Register Assignments

*5 The figure below shows the alarm status of the measured data and computed data. Each register contains data in the following order: alarm number 2/alarm number 1/alarm number 4/alarm number 3. Each alarm number uses 4 bits to specify a value in the range of 0 to 8. Values 0 to 8 correspond to high-limit alarm, low-limit alarm, difference high-limit alarm, difference low-limit alarm, high limit on rate-of-change alarm, low limit on rate-of-change alarm, delay high-limit alarm, and delay low-limit alarm, respectively.

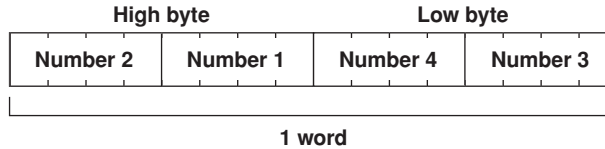

*6 The figure below shows the alarm status of the control data. Each alarm number uses 1 byte. Since a total of 4 bytes are used, 2 registers are used. The first register contains data in the following order: alarm number 2/alarm number 1. The second register contains data in the following order: alarm number 4/alarm number 3. Each alarm number uses 8 bits to specify a value of 0 or a value in the range of 21 to 30. The value 0 corresponds to alarm OFF. Values 21 to 30 correspond to PV high-limit alarm, PV low-limit alarm, deviation high-limit alarm, deviation low-limit alarm, deviation high & low limit alarm, deviation within high & low limits alarm (alarms up to this point are entered in channels 101, 104, 107, and so on that indicate the PV value of each loop), SP high-limit alarm, SP low-limit alarm (these two alarms are entered in channels 102, 105, 108, and so on that indicate the SP value of each loop), output high-limit alarm, and output low-limit alarm (these two alarms are entered in channels 103, 106, 109, and so on that indicate the OUT value of each loop), respectively.

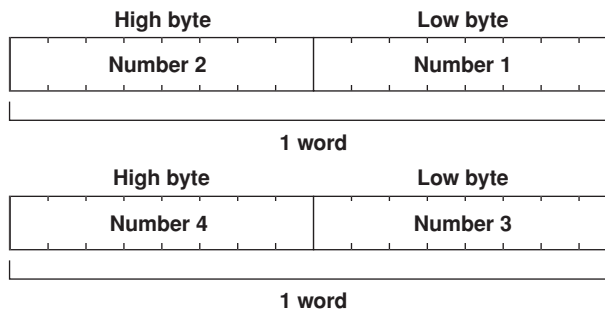

*7 The measured data alarm statuses of registers 36001 to 36005, and the computed data alarm statuses of registers 36006 to 36013 indicate the statuses of alarm numbers 1 to 4 of each channel using the bit status of the register (16 bits). If the status of alarm numbers 1 to 4 of each channel is ON, the corresponding bit is set to 1 regardless of the alarm type.

Bit Configuration of Register 36001

Bit	Corresponding Alarm	Bit Status and Alarm Status
0	Alarm number 1 of CH01	0: Alarm OFF, 1: Alarm ON
1	Alarm number 2 of CH01	0: Alarm OFF, 1: Alarm ON
2	Alarm number 3 of CH01	0: Alarm OFF, 1: Alarm ON
3	Alarm number 4 of CH01	0: Alarm OFF, 1: Alarm ON
4	Alarm number 1 of CH02	0: Alarm OFF, 1: Alarm ON
5	Alarm number 2 of CH02	0: Alarm OFF, 1: Alarm ON
6	Alarm number 3 of CH02	0: Alarm OFF, 1: Alarm ON
7	Alarm number 4 of CH02	0: Alarm OFF, 1: Alarm ON
8	Alarm number 1 of CH03	0: Alarm OFF, 1: Alarm ON
9	Alarm number 2 of CH03	0: Alarm OFF, 1: Alarm ON
10	Alarm number 3 of CH03	0: Alarm OFF, 1: Alarm ON
11	Alarm number 4 of CH03	0: Alarm OFF, 1: Alarm ON
12	Alarm number 1 of CH04	0: Alarm OFF, 1: Alarm ON
13	Alarm number 2 of CH04	0: Alarm OFF, 1: Alarm ON
14	Alarm number 3 of CH04	0: Alarm OFF, 1: Alarm ON
15	Alarm number 4 of CH04	0: Alarm OFF, 1: Alarm ON

*8 The control data alarm statuses of registers 36014 and 36015 indicate the statuses of alarm numbers 1 to 4 of each loop using the bit status of the register (16 bits). If the status of alarm numbers 1 to 4 of each loop is ON, the corresponding bit is set to 1 regardless of the alarm type. If registers 36014 and 36015 are read on a 0-loop model or if register 36015 is read on a two-loop model or four-loop model (or when four loops are selected in the “Basic setting” on a six-loop model), an error (error code 2) is returned.

Bit Configuration of Register 36014 (for loops 1 to 4)

Bit	Corresponding Alarm	Bit Status and Alarm Status
0	Alarm number 1 of loop 1	0: Alarm OFF, 1: Alarm ON
1	Alarm number 2 of loop 1	0: Alarm OFF, 1: Alarm ON
2	Alarm number 3 of loop 1	0: Alarm OFF, 1: Alarm ON
3	Alarm number 4 of loop 1	0: Alarm OFF, 1: Alarm ON
4	Alarm number 1 of loop 2	0: Alarm OFF, 1: Alarm ON
5	Alarm number 2 of loop 2	0: Alarm OFF, 1: Alarm ON
6	Alarm number 3 of loop 2	0: Alarm OFF, 1: Alarm ON
7	Alarm number 4 of loop 2	0: Alarm OFF, 1: Alarm ON
8	Alarm number 1 of loop 3	0: Alarm OFF, 1: Alarm ON
9	Alarm number 2 of loop 3	0: Alarm OFF, 1: Alarm ON
10	Alarm number 3 of loop 3	0: Alarm OFF, 1: Alarm ON
11	Alarm number 4 of loop 3	0: Alarm OFF, 1: Alarm ON
12	Alarm number 1 of loop 4	0: Alarm OFF, 1: Alarm ON
13	Alarm number 2 of loop 4	0: Alarm OFF, 1: Alarm ON
14	Alarm number 3 of loop 4	0: Alarm OFF, 1: Alarm ON
15	Alarm number 4 of loop 4	0: Alarm OFF, 1: Alarm ON

Bit Configuration of Register 36015 (for loops 5 and 6)

Bit	Corresponding Alarm	Bit Status and Alarm Status
0	Alarm number 5 of loop 1	0: Alarm OFF, 1: Alarm ON
1	Alarm number 5 of loop 2	0: Alarm OFF, 1: Alarm ON
2	Alarm number 5 of loop 3	0: Alarm OFF, 1: Alarm ON
3	Alarm number 5 of loop 4	0: Alarm OFF, 1: Alarm ON
4	Alarm number 6 of loop 1	0: Alarm OFF, 1: Alarm ON
5	Alarm number 6 of loop 2	0: Alarm OFF, 1: Alarm ON
6	Alarm number 6 of loop 3	0: Alarm OFF, 1: Alarm ON
7	Alarm number 6 of loop 4	0: Alarm OFF, 1: Alarm ON
8	–	0
9	–	0
10	–	0
11	–	0
12	–	0
13	–	0
14	–	0
15	–	0

Note

- If data of a register related to an uninstalled loop is read, a “0” is returned.
- If the data of a register assigned to auto/manual/cascade switching, run/stop switching, or remote/local switching is read immediately after the CX powers up or immediately after reverting from the basic setting mode, “-1” may be returned.

Appendix 6 Register Assignments

*9 Registers 37001–37003 (status of control module DI), 37004 (status of expansion module DI), 37011–37013 (status of control module DO), 37014 (status of expansion module DIO), and 37021–37023 (status of internal switches) show the status of each bit in the register (16-bit). The status of the DIO and internal switches are shown in order from the last bit in the register.

Bit Configuration of Register 37001

Bit	Bit and DI status
0	DI001(0: OFF, 1: ON)
1	DI002(0: OFF, 1: ON)
2	DI003(0: OFF, 1: ON)
3	DI004(0: OFF, 1: ON)
4	DI005(0: OFF, 1: ON)
5	DI006(0: OFF, 1: ON)
6-15	Unused

Bit Configuration of Register 37014

Bit	Bit and DO of expanded DIO module status
0	RO001(0: OFF, 1: ON)
1	RO002(0: OFF, 1: ON)
2	RO003(0: OFF, 1: ON)
3	RO004(0: OFF, 1: ON)
4	RO005(0: OFF, 1: ON)
5	RO006(0: OFF, 1: ON)
6	RO007(0: OFF, 1: ON)
7	RO008(0: OFF, 1: ON)
8	RO009(0: OFF, 1: ON)
9	RO010(0: OFF, 1: ON)
10	RO011(0: OFF, 1: ON)
11	RO012(0: OFF, 1: ON)
12-15	Unused

Bit Configuration of Register 37021

Bit	Bit and internal switch status
0	SW001(0: OFF, 1: ON)
1	SW002(0: OFF, 1: ON)
2	SW003(0: OFF, 1: ON)
3	SW004(0: OFF, 1: ON)
4	SW005(0: OFF, 1: ON)
5	SW006(0: OFF, 1: ON)
6	SW007(0: OFF, 1: ON)
7	SW008(0: OFF, 1: ON)
8	SW009(0: OFF, 1: ON)
9	SW010(0: OFF, 1: ON)
10	SW011(0: OFF, 1: ON)
11	SW012(0: OFF, 1: ON)
12	SW013(0: OFF, 1: ON)
13	SW014(0: OFF, 1: ON)
14	SW015(0: OFF, 1: ON)
15	SW016(0: OFF, 1: ON)

Bit Configuration of Register 37023

Bit	Bit and internal switch status
0	SW033(0: OFF, 1: ON)
1	SW034(0: OFF, 1: ON)
2	SW035(0: OFF, 1: ON)
3	SW036(0: OFF, 1: ON)
4-15	Unused

Register Assignments during Ladder Communications

The register assignments of the Modbus slave function are shown below.
 The register data does not contain unit information or decimal point position information.
 Set the information on the host side.

The alarm values and computed data of computation channels are assigned to two registers in the following order: higher 5 digits of the 10 digit BCD code and lower 5 digits.

If the data of a computation channel is –1234567 and the corresponding registers are read, the first register (higher 5 digits) is “123,” and the second register (lower 5 digits) is “34567” (the sign is negative for both registers).

On the CX1000, if you read from a register that does not exist (communication registers C13 to C30, measurement channels 07 to 20, computation channels 43 to 60, and control loops 3 to 6), “0” is returned. If you attempt to write to such register, the transmitted command is returned as-is.

• Writable and Readable Parameters

D Register Number	Description	Value	Read/Write
D0001-D0030	Communication register data	–32768 to 32767	R/W
D0101	Control operation start/stop of all loops	0: Stop 1: Start	W*1
D0301	Memory start/stop	0: Memory stop 1: Memory start	R/W
D0302	Alarm ACK	When writing 0: Execute alarm ACK When reading 0: Alarm not illuminated 1: Alarm illuminated 2: Alarm blinking	R/W
D0303	Computation start/stop	0: Stop computation 1: Start computation 2: Reset computation	R/W
D0304	Save the manual trigger, manual sampled, snapshot, display data to the external storage medium/saves the event data to the external storage medium	0: Execute manual sampling 1: Activate manual trigger 2: Snapshot 3: Save display data to the external storage medium 4: Save event data to the external storage medium	W*1
D0305	Write message	1 to 8: Message number	W*1
D0306	Revert to the operation display	0: Set the display back to the operation display	W*1
D0501	Alarm value of measurement channel 1 (Alarm number 1)	Within the measurement span excluding the decimal point (See the SA command)	R/W
D0502	Alarm value of measurement channel 1 (Alarm number 2)	Within the measurement span excluding the decimal point (See the SA command)	R/W
D0503	Alarm value of measurement channel 1 (Alarm number 3)	Within the measurement span excluding the decimal point (See the SA command)	R/W
D0504	Alarm value of measurement channel 1 (Alarm number 4)	Within the measurement span excluding the decimal point (See the SA command)	R/W
:	:	:	:
D0577	Alarm value of measurement channel 20 (Alarm number 1)	Within the measurement span excluding the decimal point (See the SA command)	R/W
D0578	Alarm value of measurement channel 20 (Alarm number 2)	Within the measurement span excluding the decimal point (See the SA command)	R/W
D0579	Alarm value of measurement channel 20 (Alarm number 3)	Within the measurement span excluding the decimal point (See the SA command)	R/W
D0580	Alarm value of measurement channel 20 (Alarm number 4)	Within the measurement span excluding the decimal point (See the SA command)	R/W

*1 If a write-only register in the registers is read, a “0” is returned.

Appendix 6 Register Assignments

D Register Number	Description	Value	Read/Write
D0601	Alarm value of computation channel 1 Upper 5 digits of alarm number 1	Value, obtained by combining the upper 5 digits and lower 5 digits, within the computation channel span excluding the decimal point (see the SA command)	R/W
D0602	Alarm value of computation channel 1 Lower 5 digits of alarm number 1	When writing, write the value in the range of –99999 to 99999 to either the upper or lower register. The value is set as above regardless of which register it is written.	R/W
D0603	Alarm value of computation channel 1 Upper 5 digits of alarm number 2	Value, obtained by combining the upper 5 digits and lower 5 digits, within the computation channel span excluding the decimal point (see the SA command)	R/W
D0604	Alarm value of computation channel 1 Lower 5 digits of alarm number 2	When writing, write the value in the range of –99999 to 99999 to either the upper or lower register. The value is set as above regardless of which register it is written.	R/W
D0605	Alarm value of computation channel 1 Upper 5 digits of alarm number 3	Value, obtained by combining the upper 5 digits and lower 5 digits, within the computation channel span excluding the decimal point (see the SA command)	R/W
D0606	Alarm value of computation channel 1 Lower 5 digits of alarm number 3	When writing, write the value in the range of –99999 to 99999 to either the upper or lower register. The value is set as above regardless of which register it is written.	R/W
D0607	Alarm value of computation channel 1 Upper 5 digits of alarm number 4	Value, obtained by combining the upper 5 digits and lower 5 digits, within the computation channel span excluding the decimal point (see the SA command)	R/W
D0608	Alarm value of computation channel 1 Lower 5 digits of alarm number 4	When writing, write the value in the range of –99999 to 99999 to either the upper or lower register. The value is set as above regardless of which register it is written.	R/W
:	:	:	:
D0833	Alarm value of computation channel 60 Upper 5 digits of alarm number 1	Value, obtained by combining the upper 5 digits and lower 5 digits, within the computation channel span excluding the decimal point (see the SA command)	R/W
D0834	Alarm value of computation channel 60 Lower 5 digits of alarm number 1	When writing, write the value in the range of –99999 to 99999 to either the upper or lower register. The value is set as above regardless of which register it is written.	R/W
D0835	Alarm value of computation channel 60 Upper 5 digits of alarm number 2	Value, obtained by combining the upper 5 digits and lower 5 digits, within the computation channel span excluding the decimal point (see the SA command)	R/W
D0836	Alarm value of computation channel 60 Lower 5 digits of alarm number 2	When writing, write the value in the range of –99999 to 99999 to either the upper or lower register. The value is set as above regardless of which register it is written.	R/W
D0837	Alarm value of computation channel 60 Upper 5 digits of alarm number 3	Value, obtained by combining the upper 5 digits and lower 5 digits, within the computation channel span excluding the decimal point (see the SA command)	R/W
D0838	Alarm value of computation channel 60 Lower 5 digits of alarm number 3	When writing, write the value in the range of –99999 to 99999 to either the upper or lower register. The value is set as above regardless of which register it is written.	R/W
D0839	Alarm value of computation channel 60 Upper 5 digits of alarm number 4	Value, obtained by combining the upper 5 digits and lower 5 digits, within the computation channel span excluding the decimal point (see the SA command)	R/W
D0840	Alarm value of computation channel 60 Lower 5 digits of alarm number 4	When writing, write the value in the range of –99999 to 99999 to either the upper or lower register. The value is set as above regardless of which register it is written.	R/W

Parameters Related to Loop 1

D Register Number	Register Type	Description	Value	Read/Write
D1001	Parameter per Loop	Enable/Disable the use of bias on PV1, bias value, bias input type	–100% to 100% of the measurement span: Bias value (bias enabled) –30001 to –32768, 30001 to 32767: Bias disabled	R/W
D1002		Enable/Disable the use of bias on PV2, bias value, bias input type	–100% to 100% of the measurement span: Bias value (bias enabled) –30001 to –32768, 30001 to 32767: Bias disabled	R/W
D1003		Enable/Disable the use of bias on RemoteSP, bias value	–100% to 100% of the measurement span: Bias value (bias enabled) –30001 to –32768, 30001 to 32767: Bias disabled	R/W
D1004		Type of filter used on PV1, enable/disable the use of the filter, filter value	1 to 120: Filter value (filter enabled) –30001 to –32768, 30001 to 32767: Filter disabled	R/W
D1005		Type of filter used on PV2, enable/disable the use of the filter, filter value	1 to 120: Filter value (filter enabled) –30001 to –32768, 30001 to 32767: Filter disabled	R/W
D1006		Type of filter used on RemoteSP, enable/disable the use of the filter, filter value	1 to 120: Filter value (filter enabled) –30001 to –32768, 30001 to 32767: Filter disabled	R/W
D1007		Enable/Disable ratio setting and the ratio value	1 to 9999: ratio value (ratio setting enabled) –30001 to –32768, 30001 to 32767: Ratio setting disabled	R/W
D1008		Suppressing function On/Off	0: Suppressing function OFF 1: Suppressing function ON	R/W
D1009		Ramp-rate-time unit	0: Hour 2: Second 1: Minute	R/W
D1010		SP ramp-up-rate	Value between 1 and the maximum value of the measurement span excluding the decimal point. –30001 to –32768, 30001 to 32767: OFF	R/W
D1011		SP ramp-down-rate	Value between 1 and the maximum value of the measurement span excluding the decimal point. –30001 to –32768, 30001 to 32767: OFF	R/W
D1012		Switch between auto, manual, and cascade control	0: Auto switching 1: Manual switching 2: Cascade switching (valid only during cascade control)	R/W
D1013		SP number	1 to 8: SP number	R/W
D1014		Switch run/stop	0: Stop 1: Start	R/W
D1015		Remote/local switching	0: Local 1: Remote	R/W
D1016		Currently used PID number	1 to 8: PID number	R
D1017		OUT value in manual mode	–50 to 1050: –5.0% to 105.0%	R/W
D1018		Auto tuning (AT) status	0: AT not in progress 1: AT in progress	R
D1019		Decimal point position of ratio value	0 to 4	R/W

Appendix 6 Register Assignments

D Register Number	Register Type	Description	Value	Read/Write
D1101	PID parameter of PID number 1 of loop 1	Target setpoint (SP)	Within the measurement span excluding the decimal point	
D1102		Proportional band (P)	1 to 9999: 0.1 to 999.9%	R/W
D1103		Integral time (I)	0 to 6000	
D1104		Derivative time (D)	0 to 6000	R/W
D1105		Output low-limit	-50 to 1050: -5.0% to 105.0%	R/W
D1106		Output high-limit	-50 to 1050: -5.0% to 105.0%	R/W
D1107		Shutdown function enable/disable	0: OFF 1: ON	R/W R/W
D1108		Manual reset	-50 to 1050: -5.0% to 105.0%	R/W
D1109		Hysteresis value	Within the measurement span excluding the decimal point	R/W
D1110		Hysteresis activation point	0: OFF 1: Upper 2: Lower	R/W R/W
D1111		Control action direction switching	0: Reverse 1: Direct	
D1112			Preset output	-50 to 1050: -5.0% to 105.0%
D1125	Control alarm value of PID number 1 of loop 1	Control alarm value (Alarm number 1)	Varies depending on the alarm type as follows: SP/PV alarm Within the measurement span excluding the decimal point Deviation alarm (high-limit and low-limit) Within EUS -100.0 to 100.0% of the measurement span excluding the decimal point Deviation alarm (high & low limit and within high & low limits) Within EUS 0.0 to -100.0% of the measurement span excluding the decimal point Output alarm -50 to 1050: -5.0% to 105.0% (See the AV command)	R/W R/W
D1126		Control alarm value (Alarm number 2)	Same as above	R/W
D1127		Control alarm value (Alarm number 3)	Same as above	R/W
D1128		Control alarm value (Alarm number 4)	Same as above	R/W
D1131-D1142	PID parameter of PID number 2 of loop 1	Same as the PID parameters of PID number 1 of loop 1	Same as the range for the PID parameters of PID number 1 of loop 1	R/W
D1155-D1158	Control alarm value of PID number 2 of loop 1	Same as the control alarm values of PID number 1 of loop 1	Same as the range for the control alarm values of PID number 1 of loop 1	R/W
D1161-D1172	PID parameter of PID number 3 of loop 1	Same as the PID parameters of PID number 1 of loop 1	Same as the range for the PID parameters of PID number 1 of loop 1	R/W

D Register Number	Register Type	Description	Value	Read/Write
D1185-D1188	Control alarm value of PID number 3 of loop 1	Same as the control alarm values of PID number 1 of loop 1	Same as the range for the control alarm values of PID number 1 of loop 1	R/W
D1191-D1202	PID parameter of PID number 4 of loop 1	Same as the PID parameters of PID number 1 of loop 1	Same as the range for the PID parameters of PID number 1 of loop 1	R/W
D1215-D1218	Control alarm value of PID number 4 of loop 1	Same as the control alarm values of PID number 1 of loop 1	Same as the range for the control alarm values of PID number 1 of loop 1	R/W
D1221-D1232	PID parameter of PID number 5 of loop 1	Same as the PID parameters of PID number 1 of loop 1	Same as the range for the PID parameters of PID number 1 of loop 1	R/W
D1245-D1248	Control alarm value of PID number 5 of loop 1	Same as the control alarm values of PID number 1 of loop 1	Same as the range for the control alarm values of PID number 1 of loop 1	R/W
D1251-D1262	PID parameter of PID number 6 of loop 1	Same as the PID parameters of PID number 1 of loop 1	Same as the range for the PID parameters of PID number 1 of loop 1	R/W
D1275-D1278	Control alarm value of PID number 6 of loop 1	Same as the control alarm values of PID number 1 of loop 1	Same as the range for the control alarm values of PID number 1 of loop 1	R/W
D1281-D1292	PID parameter of PID number 7 of loop 1	Same as the PID parameters of PID number 1 of loop 1	Same as the range for the PID parameters of PID number 1 of loop 1	R/W
D1305-D1308	Control alarm value of PID number 7 of loop 1	Same as the control alarm values of PID number 1 of loop 1	Same as the range for the control alarm values of PID number 1 of loop 1	R/W
D1311-D1322	PID parameter of PID number 8 of loop 1	Same as the PID parameters of PID number 1 of loop 1	Same as the range for the PID parameters of PID number 1 of loop 1	R/W
D1335-D1338	Control alarm value of PID number 8 of loop 1	Same as the control alarm values of PID number 1 of loop 1	Same as the range for the control alarm values of PID number 1 of loop 1	R/W

Appendix 6 Register Assignments

Parameters Related to Loop 2

D Register Number	Register Type	Description	Value	Read/Write
D1501-D1519	Parameter per Loop	Same as the parameters for loop 1	Same as the range for the parameters for loop 1	R/W
D1601-D1612	PID parameter of PID number 1 of loop 2	Same as the PID parameters of PID number 1 of loop 1	Same as the range for the PID parameters of PID number 1 of loop 1	R/W
D1625-D1628	Control alarm value of PID number 1 of loop 2	Same as the control alarm values of PID number 1 of loop 1	Same as the range for the control alarm values of PID number 1 of loop 1	R/W
D1631-D1642	PID parameter of PID number 2 of loop 2	Same as the PID parameters of PID number 1 of loop 1	Same as the range for the PID parameters of PID number 1 of loop 1	R/W
D1655-D1658	Control alarm value of PID number 2 of loop 2	Same as the control alarm values of PID number 1 of loop 1	Same as the range for the control alarm values of PID number 1 of loop 1	R/W
D1661-D1672	PID parameter of PID number 3 of loop 2	Same as the PID parameters of PID number 1 of loop 1	Same as the range for the PID parameters of PID number 1 of loop 1	R/W
D1685-D1688	Control alarm value of PID number 3 of loop 2	Same as the control alarm values of PID number 1 of loop 1	Same as the range for the control alarm values of PID number 1 of loop 1	R/W
D1691-D1702	PID parameter of PID number 4 of loop 2	Same as the PID parameters of PID number 1 of loop 1	Same as the range for the PID parameters of PID number 1 of loop 1	R/W
D1715-D1718	Control alarm value of PID number 4 of loop 2	Same as the control alarm values of PID number 1 of loop 1	Same as the range for the control alarm values of PID number 1 of loop 1	R/W
D1721-D1732	PID parameter of PID number 5 of loop 2	Same as the PID parameters of PID number 1 of loop 1	Same as the range for the PID parameters of PID number 1 of loop 1	R/W
D1745-D1748	Control alarm value of PID number 5 of loop 2	Same as the control alarm values of PID number 1 of loop 1	Same as the range for the control alarm values of PID number 1 of loop 1	R/W
D1751-D1762	PID parameter of PID number 6 of loop 2	Same as the PID parameters of PID number 1 of loop 1	Same as the range for the PID parameters of PID number 1 of loop 1	R/W
D1775-D1778	Control alarm value of PID number 6 of loop 2	Same as the control alarm values of PID number 1 of loop 1	Same as the range for the control alarm values of PID number 1 of loop 1	R/W
D1781-D1792	PID parameter of PID number 7 of loop 2	Same as the PID parameters of PID number 1 of loop 1	Same as the range for the PID parameters of PID number 1 of loop 1	R/W
D1805-D1808	Control alarm value of PID number 7 of loop 2	Same as the control alarm values of PID number 1 of loop 1	Same as the range for the control alarm values of PID number 1 of loop 1	R/W
D1811-D1822	PID parameter of PID number 8 of loop 2	Same as the PID parameters of PID number 1 of loop 1	Same as the range for the PID parameters of PID number 1 of loop 1	R/W
D1835-D1838	Control alarm value of PID number 8 of loop 2	Same as the control alarm values of PID number 1 of loop 1	Same as the range for the control alarm values of PID number 1 of loop 1	R/W

Parameters Related to Loop 3

D Register Number	Register Type	Description	Value	Read/Write
D2001-D2019	Parameter per Loop	Same as the parameters for loop 1	Same as the range for the parameters for loop 1	R/W
D2101-D2112	PID parameter of PID number 1 of loop 3	Same as the PID parameters of PID number 1 of loop 1	Same as the range for the PID parameters of PID number 1 of loop 1	R/W
D2125-D2128	Control alarm value of PID number 1 of loop 3	Same as the control alarm values of PID number 1 of loop 1	Same as the range for the control alarm values of PID number 1 of loop 1	R/W
D2131-D2142	PID parameter of PID number 2 of loop 3	Same as the PID parameters of PID number 1 of loop 1	Same as the range for the PID parameters of PID number 1 of loop 1	R/W
D2155-D2158	Control alarm value of PID number 2 of loop 3	Same as the control alarm values of PID number 1 of loop 1	Same as the range for the control alarm values of PID number 1 of loop 1	R/W
D2161-D2172	PID parameter of PID number 3 of loop 3	Same as the PID parameters of PID number 1 of loop 1	Same as the range for the PID parameters of PID number 1 of loop 1	R/W
D2185-D2188	Control alarm value of PID number 3 of loop 3	Same as the control alarm values of PID number 1 of loop 1	Same as the range for the control alarm values of PID number 1 of loop 1	R/W
D2191-D2202	PID parameter of PID number 4 of loop 3	Same as the PID parameters of PID number 1 of loop 1	Same as the range for the PID parameters of PID number 1 of loop 1	R/W
D2215-D2218	Control alarm value of PID number 4 of loop 3	Same as the control alarm values of PID number 1 of loop 1	Same as the range for the control alarm values of PID number 1 of loop 1	R/W
D2221-D2232	PID parameter of PID number 5 of loop 3	Same as the PID parameters of PID number 1 of loop 1	Same as the range for the PID parameters of PID number 1 of loop 1	R/W
D2245-D2248	Control alarm value of PID number 5 of loop 3	Same as the control alarm values of PID number 1 of loop 1	Same as the range for the control alarm values of PID number 1 of loop 1	R/W
D2251-D2262	PID parameter of PID number 6 of loop 3	Same as the PID parameters of PID number 1 of loop 1	Same as the range for the PID parameters of PID number 1 of loop 1	R/W
D2275-D2278	Control alarm value of PID number 6 of loop 3	Same as the control alarm values of PID number 1 of loop 1	Same as the range for the control alarm values of PID number 1 of loop 1	R/W
D2281-D2292	PID parameter of PID number 7 of loop 3	Same as the PID parameters of PID number 1 of loop 1	Same as the range for the PID parameters of PID number 1 of loop 1	R/W
D2305-D2308	Control alarm value of PID number 7 of loop 3	Same as the control alarm values of PID number 1 of loop 1	Same as the range for the control alarm values of PID number 1 of loop 1	R/W
D2311-D2322	PID parameter of PID number 8 of loop 3	Same as the PID parameters of PID number 1 of loop 1	Same as the range for the PID parameters of PID number 1 of loop 1	R/W
D2335-D2338	Control alarm value of PID number 8 of loop 3	Same as the control alarm values of PID number 1 of loop 1	Same as the range for the control alarm values of PID number 1 of loop 1	R/W

Appendix 6 Register Assignments

Parameters Related to Loop 4

D Register Number	Register Type	Description	Value	Read/Write
D2501-D2519	Parameter per Loop	Same as the parameters for loop 1	Same as the range for the parameters for loop 1	R/W
D2601-D2612	PID parameter of PID number 1 of loop 4	Same as the PID parameters of PID number 1 of loop 1	Same as the range for the PID parameters of PID number 1 of loop 1	R/W
D2625-D2628	Control alarm value of PID number 1 of loop 4	Same as the control alarm values of PID number 1 of loop 1	Same as the range for the control alarm values of PID number 1 of loop 1	R/W
D2631-D2642	PID parameter of PID number 2 of loop 4	Same as the PID parameters of PID number 1 of loop 1	Same as the range for the PID parameters of PID number 1 of loop 1	R/W
D2655-D2658	Control alarm value of PID number 2 of loop 4	Same as the control alarm values of PID number 1 of loop 1	Same as the range for the control alarm values of PID number 1 of loop 1	R/W
D2661-D2672	PID parameter of PID number 3 of loop 4	Same as the PID parameters of PID number 1 of loop 1	Same as the range for the PID parameters of PID number 1 of loop 1	R/W
D2685-D2688	Control alarm value of PID number 3 of loop 4	Same as the control alarm values of PID number 1 of loop 1	Same as the range for the control alarm values of PID number 1 of loop 1	R/W
D2691-D2702	PID parameter of PID number 4 of loop 4	Same as the PID parameters of PID number 1 of loop 1	Same as the range for the PID parameters of PID number 1 of loop 1	R/W
D2715-D2718	Control alarm value of PID number 4 of loop 4	Same as the control alarm values of PID number 1 of loop 1	Same as the range for the control alarm values of PID number 1 of loop 1	R/W
D2721-D2732	PID parameter of PID number 5 of loop 4	Same as the PID parameters of PID number 1 of loop 1	Same as the range for the PID parameters of PID number 1 of loop 1	R/W
D2745-D2748	Control alarm value of PID number 5 of loop 4	Same as the control alarm values of PID number 1 of loop 1	Same as the range for the control alarm values of PID number 1 of loop 1	R/W
D2751-D2762	PID parameter of PID number 6 of loop 4	Same as the PID parameters of PID number 1 of loop 1	Same as the range for the PID parameters of PID number 1 of loop 1	R/W
D2775-D2778	Control alarm value of PID number 6 of loop 4	Same as the control alarm values of PID number 1 of loop 1	Same as the range for the control alarm values of PID number 1 of loop 1	R/W
D2781-D2792	PID parameter of PID number 7 of loop 4	Same as the PID parameters of PID number 1 of loop 1	Same as the range for the PID parameters of PID number 1 of loop 1	R/W
D2805-D2808	Control alarm value of PID number 7 of loop 4	Same as the control alarm values of PID number 1 of loop 1	Same as the range for the control alarm values of PID number 1 of loop 1	R/W
D2811-D2822	PID parameter of PID number 8 of loop 4	Same as the PID parameters of PID number 1 of loop 1	Same as the range for the PID parameters of PID number 1 of loop 1	R/W
D2835-D2838	Control alarm value of PID number 8 of loop 4	Same as the control alarm values of PID number 1 of loop 1	Same as the range for the control alarm values of PID number 1 of loop 1	R/W

Parameters Related to Loop 5

D Register Number	Register Type	Description	Value	Read/Write
D3001-D3019	Parameter per Loop	Same as the parameters for loop 1*2	Same as the range for the parameters for loop 1	R/W
D3101-D3112	PID parameter of PID number 1 of loop 5	Same as the PID parameters of PID number 1 of loop 1	Same as the range for the PID parameters of PID number 1 of loop 1	R/W
D3125-D3128	Control alarm value of PID number 1 of loop 5	Same as the control alarm values of PID number 1 of loop 1	Same as the range for the control alarm values of PID number 1 of loop 1	R/W
D3131-D3142	PID parameter of PID number 2 of loop 5	Same as the PID parameters of PID number 1 of loop 1	Same as the range for the PID parameters of PID number 1 of loop 1	R/W
D3155-D3158	Control alarm value of PID number 2 of loop 5	Same as the control alarm values of PID number 1 of loop 1	Same as the range for the control alarm values of PID number 1 of loop 1	R/W
D3161-D3172	PID parameter of PID number 3 of loop 5	Same as the PID parameters of PID number 1 of loop 1	Same as the range for the PID parameters of PID number 1 of loop 1	R/W
D3185-D3188	Control alarm value of PID number 3 of loop 5	Same as the control alarm values of PID number 1 of loop 1	Same as the range for the control alarm values of PID number 1 of loop 1	R/W
D3191-D3202	PID parameter of PID number 4 of loop 5	Same as the PID parameters of PID number 1 of loop 1	Same as the range for the PID parameters of PID number 1 of loop 1	R/W
D3215-D3218	Control alarm value of PID number 4 of loop 5	Same as the control alarm values of PID number 1 of loop 1	Same as the range for the control alarm values of PID number 1 of loop 1	R/W
D3221-D3232	PID parameter of PID number 5 of loop 5	Same as the PID parameters of PID number 1 of loop 1	Same as the range for the PID parameters of PID number 1 of loop 1	R/W
D3245-D3248	Control alarm value of PID number 5 of loop 5	Same as the control alarm values of PID number 1 of loop 1	Same as the range for the control alarm values of PID number 1 of loop 1	R/W
D3251-D3262	PID parameter of PID number 6 of loop 5	Same as the PID parameters of PID number 1 of loop 1	Same as the range for the PID parameters of PID number 1 of loop 1	R/W
D3275-D3278	Control alarm value of PID number 6 of loop 5	Same as the control alarm values of PID number 1 of loop 1	Same as the range for the control alarm values of PID number 1 of loop 1	R/W
D3281-D3292	PID parameter of PID number 7 of loop 5	Same as the PID parameters of PID number 1 of loop 1	Same as the range for the PID parameters of PID number 1 of loop 1	R/W
D3305-D3308	Control alarm value of PID number 7 of loop 5	Same as the control alarm values of PID number 1 of loop 1	Same as the range for the control alarm values of PID number 1 of loop 1	R/W
D3311-D3322	PID parameter of PID number 8 of loop 5	Same as the PID parameters of PID number 1 of loop 1	Same as the range for the PID parameters of PID number 1 of loop 1	R/W
D3335-D3338	Control alarm value of PID number 8 of loop 5	Same as the control alarm values of PID number 1 of loop 1	Same as the range for the control alarm values of PID number 1 of loop 1	R/W

*2 Loops 5 and 6 do not have Remote, bias setting against PV range, filter setting, and remote/local switching.

Appendix 6 Register Assignments

Parameters Related to Loop 6

D Register Number	Register Type	Description	Value	Read/Write
D3501-D3519	Parameter per Loop	Same as the parameters for loop 1*2	Same as the range for the parameters for loop 1	R/W
D3601-D3612	PID parameter of PID number 1 of loop 6	Same as the PID parameters of PID number 1 of loop 1	Same as the range for the PID parameters of PID number 1 of loop 1	R/W
D3625-D3628	Control alarm value of PID number 1 of loop 6	Same as the control alarm values of PID number 1 of loop 1	Same as the range for the control alarm values of PID number 1 of loop 1	R/W
D3631-D3642	PID parameter of PID number 2 of loop 6	Same as the PID parameters of PID number 1 of loop 1	Same as the range for the PID parameters of PID number 1 of loop 1	R/W
D3655-D3658	Control alarm value of PID number 2 of loop 6	Same as the control alarm values of PID number 1 of loop 1	Same as the range for the control alarm values of PID number 1 of loop 1	R/W
D3661-D3672	PID parameter of PID number 3 of loop 6	Same as the PID parameters of PID number 1 of loop 1	Same as the range for the PID parameters of PID number 1 of loop 1	R/W
D3685-D3688	Control alarm value of PID number 3 of loop 6	Same as the control alarm values of PID number 1 of loop 1	Same as the range for the control alarm values of PID number 1 of loop 1	R/W
D3691-D3702	PID parameter of PID number 4 of loop 6	Same as the PID parameters of PID number 1 of loop 1	Same as the range for the PID parameters of PID number 1 of loop 1	R/W
D3715-D3718	Control alarm value of PID number 4 of loop 6	Same as the control alarm values of PID number 1 of loop 1	Same as the range for the control alarm values of PID number 1 of loop 1	R/W
D3721-D3732	PID parameter of PID number 5 of loop 6	Same as the PID parameters of PID number 1 of loop 1	Same as the range for the PID parameters of PID number 1 of loop 1	R/W
D3745-D3748	Control alarm value of PID number 5 of loop 6	Same as the control alarm values of PID number 1 of loop 1	Same as the range for the control alarm values of PID number 1 of loop 1	R/W
D3751-D3762	PID parameter of PID number 6 of loop 6	Same as the PID parameters of PID number 1 of loop 1	Same as the range for the PID parameters of PID number 1 of loop 1	R/W
D3775-D3778	Control alarm value of PID number 6 of loop 6	Same as the control alarm values of PID number 1 of loop 1	Same as the range for the control alarm values of PID number 1 of loop 1	R/W
D3781-D3792	PID parameter of PID number 7 of loop 6	Same as the PID parameters of PID number 1 of loop 1	Same as the range for the PID parameters of PID number 1 of loop 1	R/W
D3805-D3808	Control alarm value of PID number 7 of loop 6	Same as the control alarm values of PID number 1 of loop 1	Same as the range for the control alarm values of PID number 1 of loop 1	R/W
D3811-D3822	PID parameter of PID number 8 of loop 6	Same as the PID parameters of PID number 1 of loop 1	Same as the range for the PID parameters of PID number 1 of loop 1	R/W
D3835-D3838	Control alarm value of PID number 8 of loop 6	Same as the control alarm values of PID number 1 of loop 1	Same as the range for the control alarm values of PID number 1 of loop 1	R/W

*2 Loops 5 and 6 do not have Remote, bias setting against PV range, filter setting, ratio setting, and remote/local switching.

• **Control Channel Bias and Filter Values When PV/SP Computation is ON**

When PV/SP computation is ON, the bias and filter values for PV1 and PV2 specified by loops is set by control channel.

Modbus Register Number	Register Type	Description	Value	Read/Write	
D4901		Enable/Disable the use of bias on CI01, bias value	-100% to 100% of the control input range: Bias value (bias enabled)	R/W	
D4902		Enable/Disable the use of bias on CI02, bias value, bias input type			-30001 to -32768, 30001 to 32767: Bias disabled
:		:			
D4910		Enable/Disable the use of bias on CI10, bias value			
D4911		Type of filter used on CI01, enable/disable the use of the filter, filter value	1 to 120: Filter value (filter enabled) -30001 to -32768, 30001 to 32767: Filter disabled	R/W	
D4912		Type of filter used on CI02, enable/disable the use of the filter, filter value			
:		:			
D4920	Type of filter used on CI10, enable/disable the use of the filter, filter value				

Appendix 6 Register Assignments

• Program Control Parameters

Modbus Register Number	Register Type	Description	Value	Read/Write
D4001		Program run/stop	0: Stop, 1: Run	R/W
D4002		Hold program operation	0: None, 1: in HOLD	R/W
D4003		Advance segment	1: Advance request	W
D4004		Switch pattern number: Only when program operation is stopped	1: Pattern number 1 : 30: Pattern number 30	W
D4005		Pattern number in operation	1: Pattern number 1 : 30: Pattern number 30	R
D4006		Segment number in operation	0-99 0 is the time between program control start and program pattern control start.	R
D4007		Number of segments of the pattern used currently	1-99	R
D4008		Remaining segment time of the pattern in operation (hh)	0-99 ^{*3}	R
D4009		Remaining segment time of the pattern in operation (mm)	0-59 ^{*3}	R
D4010		Remaining segment time of the pattern in operation (ss)	0-59 ^{*3}	R
D4011		Wait mode	0: None, 1: in wait mode	R
D4012		Elapsed wait time in wait mode (hh)	0-99 ^{*3}	R
D4013		Elapsed wait time in wait mode (mm)	0-59 ^{*3}	R
D4014		Elapsed wait time in wait mode (ss)	0-59 ^{*3}	R
D4015-D4020		Reserved	0	R
D4021		Repeat setting of the current pattern	0: OFF 1: ON 2: Repeat infinite number of times	R
D4022		Repeat frequency of the pattern in operation	0-999	R
D4023		Remaining repeat frequency of the pattern in operation	0-999	R
D4024		Repeat start number of the pattern in operation	1-99	R
D4025		Repeat end number of the pattern in operation	1-99	R
D4026-D4030		Reserved	0	R
D4031		Program control end signal	0: None, 1: Program control end	R
D4032		PV event status	^{*4}	R
D4033		Time event status	^{*4}	R

^{*3} To read the remaining segment time and the elapsed wait time (hh:mm:ss), read three registers.

^{*4} Each register bit (16 bits) indicates the event status corresponding to each event number. When the setting is "1," the event is ON. When the data is read using ladder communications, the 16-bit signed data converted to BCD is returned. Therefore, the host computer must convert the value to 16-bit signed integer.

Bit	Event number	Bit Status and Event Status
0	1	0: Event OFF, 1: Event ON
1	2	0: Event OFF, 1: Event ON
2	3	0: Event OFF, 1: Event ON
3	4	0: Event OFF, 1: Event ON
4	5	0: Event OFF, 1: Event ON
5	6	0: Event OFF, 1: Event ON
6	7	0: Event OFF, 1: Event ON
7	8	0: Event OFF, 1: Event ON
8	9	0: Event OFF, 1: Event ON
9	10	0: Event OFF, 1: Event ON
10	11	0: Event OFF, 1: Event ON
11	12	0: Event OFF, 1: Event ON
12	13	0: Event OFF, 1: Event ON
13	14	0: Event OFF, 1: Event ON
14	15	0: Event OFF, 1: Event ON
15	16	0: Event OFF, 1: Event ON

• Program Individual Control Parameters

D Register Number	Register Type	Description	Value	Read/Write
D8101		Pattern number used as pattern id1	1: Pattern number 1 : 30: Pattern number 30	R
D8102		Pattern number used as pattern id2	1: Pattern number 1 : 30: Pattern number 30	R
D8103		Pattern number used as pattern id3	1: Pattern number 1 : 30: Pattern number 30	R
D8104		Pattern number used as pattern id4	1: Pattern number 1 : 30: Pattern number 30	R
D8105		Pattern number used as pattern id5	1: Pattern number 1 : 30: Pattern number 30	R
D8106		Pattern number used as pattern id6	1: Pattern number 1 : 30: Pattern number 30	R
D8107 to D8112		Run/stop programs of patterns id1–6	0: stop, 1: run	R
D8113 to D8118		Run/hold programs of patterns id1–6	0: none, 1: holding	R
D8119 to D8124		Segment number of executing pattern id1–6	0–99. However 0 indicates the time until the program pattern starts running after the program starts running.	R
D8125 to D8130		Number of segments of pattern id1–6	1-99	R
D8131		Remaining segment time (hh) of pattern id1	0-59*3	R
D8132		Remaining segment time (mm) of pattern id1	0-59*3	R
D8133		Remaining segment time (ss) of pattern id1	0-59*3	R
D8134		Remaining segment time (hh) of pattern id2	0-59*3	R
D8135		Remaining segment time (mm) of pattern id2	0-59*3	R
D8136		Remaining segment time (ss) of pattern id2	0-59*3	R
:		:	:	R
D8146		Remaining segment time (hh) of pattern id6	0-59*3	R
D8147		Remaining segment time (mm) of pattern id6	0-59*3	R
D8148		Remaining segment time (ss) of pattern id6	0-59*3	R
D8149 to D8154	Wait status	0:None 1: waiting	R	

D Register Number	Register Type	Description	Value	Read/Write
D8155		Switch time of pattern id1, and elapsed wait time (hh) when waiting.	0-59*3	R
D8156		Switch time of pattern id1, and elapsed wait time (mm) when waiting.	0-59*3	R
D8157		Switch time of pattern id1, and elapsed wait time (ss) when waiting.	0-59*3	R
:		:	:	:
D8170		Switch time of pattern id6, and elapsed wait time (hh) when waiting.	0-59*3	R
D8171		Switch time of pattern id6, and elapsed wait time (mm) when waiting.	0-59*3	R
D8172		Switch time of pattern id6, and elapsed wait time (ss) when waiting.	0-59*3	R
D8173 to D8180		Reserved		:
D8181 to D8186		Repeat setting of pattern id1-6	0:OFF 1:ON 2:Unlimited repetitions	R
D8187 to D8192		Repeat count of pattern id1-6	0-999. However, active only when repeat setting is 1 (ON).	R
D8193 to D8198		Remaining repeat count of pattern id1-6	0-999	R
D8199 to D8204		Repeat start number of pattern id1-6	1-99	R
D8205 to D8210		Repeat end number of pattern id1-6	1-99	R
D8211 to D8300		Reserved		
D8301 to D8306		Pattern end signal of pattern id1-6	0:None 1: pattern end	R
D8307 to D8312		Time event status of pattern id1-6		R
D8313 to D8318		PV event status of pattern id1-6		R

Note

The relation between pattern id and pattern number is determined by reading the operating/stopped registers (D8107-D8112).

• Write Registers for DO/internal switches

D Register Number	Register Type	Description	Value	Read/Write
D4501		DO001	0: OFF, 1: ON	R/W
D4502		DO002	0: OFF, 1: ON	R/W
D4503		DO003	0: OFF, 1: ON	R/W
D4504		DO004	0: OFF, 1: ON	R/W
D4505		DO005	0: OFF, 1: ON	R/W
D4506		DO006	0: OFF, 1: ON	R/W
D4507 to D4512		DO101 to DO106	0: OFF, 1: ON	R/W
D4513 to D4518		DO201 to DO206	0: OFF, 1: ON	R/W
D4519 to D4530		RO001 to RO012	0: OFF, 1: ON	R/W
D4531 to D4600		Reserved		
D4601 to D4636		SW001 to SW036	0: OFF, 1: ON	R/W

• Read-only Parameters

D Register Number	Description	Data	Read/Write
D5001	Measured data	Measured data of CH01	R
:	:	:	:
D5020	Measured data	Measured data of CH30	R
D5501	Measured data alarm status	Alarm status of measured data of CH01 ⁵	R
:	:	:	:
D5520	Measured data alarm status	Alarm status of measured data of CH01 ⁵	R
D6001	Computed data	Computed data of CH31 (upper 5 digits)	R
D6002	Computed data	Computed data of CH31 (lower 5 digits)	R
:	:	:	:
D6059	Computed data	Computed data of CH60 (upper 5 digits)	R
D6060	Computed data	Computed data of CH60 (lower 5 digits)	R
D6501	Computed data alarm status	Alarm status of measured data of CH31 ⁵	R
:	:	:	:
D6530	Computed data alarm status	Alarm status of measured data of CH60 ⁵	R
D7001	Control data	Control data of CH101	R
:	:	:	:
D7018	Control data	Control data of CH118	R
D7501	Control data alarm status	Alarm status of control data of CH101 ⁶ "A2A1"	R
D7502	Control data alarm status	Alarm status of control data of CH101 ⁶ "A4A3"	R
:	:	:	:
D7535	Control data alarm status	Alarm status of control data of CH118 ⁶ "A2A1"	R
D7536	Control data alarm status	Alarm status of control data of CH118 ⁶ "A4A3"	R
D7601	Measured data alarm status (CH01 to CH04)	Alarm status of alarm number 1 to 4 for CH01 to CH04 ⁷	R
:	:	:	:
D7605	Measured data alarm status (CH17 to CH20)	Alarm status of alarm number 1 to 4 for CH17 to CH20 ⁷	R
D7606	Computed data alarm status (CH31 to CH34)	Alarm status of alarm number 1 to 4 for CH31 to CH34 ⁷	R
:	:	:	:
D7613	Computed data alarm status (CH59 and CH60)	Alarm status of alarm number 1 to 4 for CH59 and CH60 ⁷	R
D7614	Control data alarm status (for loops 1 to 4)	Alarm status of alarm number 1 to 4 for loops 1 to 4 ⁸	R
D7615	Control data alarm status (for loops 5 and 6)	Alarm status of alarm number 1 to 4 for loops 5 and 6 ⁸	R
D7801	DI001-DI006 status	⁹	R
D7802	DI101-DI106 status	⁹	R
D7803	DI201-DI206 status	⁹	R
D7804	RI001-RI012 status	⁹	R
D7805 to D7810	Reserved		
D7811	DO001-DO006 status	⁹	R
D7812	DO101-DO106 status	⁹	R
D7813	DO201-DO206 status	⁹	R
D7814	RO001-RO012 status	⁹	R
D7815 to D7820	Reserved		
D7821	SW001-SW016 status	⁹	R
D7822	SW017-SW032 status	⁹	R
D7823	SW033-SW036 status	⁹	R
D9001	Year	Year (4 digits)	R
D9002	Month	1 to 12	R
D9003	Day	1 to 31	R
D9004	Hour	0 to 59	R
D9005	Minute	0 to 59	R
D9006	Second	0 to 99	R
D9007	Millisecond	0 to 07 Value in units of 125 ms	R
D9008	Daylight savings time	0: Winter time 1: Summer time	R

Appendix 6 Register Assignments

- *5 The figure below shows the alarm status of the measured data and computed data. The register contains 16-bit signed integer data in the following order: alarm number 2/alarm number 1/alarm number 4/alarm number 3. Each alarm number uses 4 bits to specify a value in the range of 0 to 8. Values 0 to 8 correspond to high-limit alarm, low-limit alarm, difference low-limit alarm, high limit on rate-of-change alarm, low limit on rate-of-change alarm, delay high-limit alarm, and delay low-limit alarm, respectively. When the data is read using ladder communications, the 16-bit signed data converted to BCD is returned. Therefore, the host computer must convert the value to 16-bit signed integer.

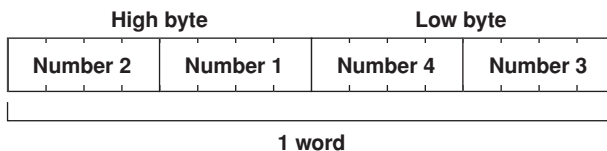

- *6 The figure below shows the alarm status of the control data. Each alarm number uses 1 byte. Since total of 4 bytes are used, 2 registers are used. The first register contains data in the following order: alarm number 2/alarm number 1. The second register contains data in the following order: alarm number 4/alarm number 3. Each alarm number uses 8 bits to specify a value of 0 or a value in the range of 21 to 30. The value 0 corresponds to alarm OFF. Values 21 to 30 correspond to PV high-limit alarm, PV low-limit alarm, deviation high-limit alarm, deviation low-limit alarm, deviation high & low limit alarm, deviation within high & low limits alarm (alarms up to this point are entered in channels 101, 104, 107, and so on that indicate the PV value of each loop), SP high-limit alarm, SP low-limit alarm (these two alarms are entered in channels 102, 105, 108, and so on that indicate the SP value of each loop), output high-limit alarm, and output low-limit alarm (these two alarms are entered in channels 103, 106, 109, and so on that indicate the OUT value of each loop), respectively. Like *5, the BCD data read from a register must be converted to a 16-bit signed integer.

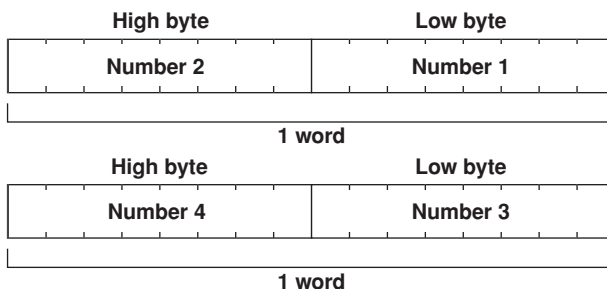

- *7 The measured data alarm statuses of registers D7601 to D7605, and the computed data alarm statuses of registers D7606 to D7613 indicate the statuses of alarm numbers 1 to 4 of each channel using the bit status of the register (16 bits). If the status of alarm numbers 1 to 4 of each channel is ON, the corresponding bit is set to 1 regardless of the alarm type. When the data is read using ladder communications, the 16-bit signed data converted to BCD is returned. Therefore, the host computer must convert the value to 16-bit signed integer.

Bit Configuration of Register D7601

Bit	Corresponding Alarm	Bit Status and Alarm Status
0	Alarm number 1 of CH01	0: Alarm OFF, 1: Alarm ON
1	Alarm number 2 of CH01	0: Alarm OFF, 1: Alarm ON
2	Alarm number 3 of CH01	0: Alarm OFF, 1: Alarm ON
3	Alarm number 4 of CH01	0: Alarm OFF, 1: Alarm ON
4	Alarm number 1 of CH02	0: Alarm OFF, 1: Alarm ON
5	Alarm number 2 of CH02	0: Alarm OFF, 1: Alarm ON
6	Alarm number 3 of CH02	0: Alarm OFF, 1: Alarm ON
7	Alarm number 4 of CH02	0: Alarm OFF, 1: Alarm ON
8	Alarm number 1 of CH03	0: Alarm OFF, 1: Alarm ON
9	Alarm number 2 of CH03	0: Alarm OFF, 1: Alarm ON
10	Alarm number 3 of CH03	0: Alarm OFF, 1: Alarm ON
11	Alarm number 4 of CH03	0: Alarm OFF, 1: Alarm ON
12	Alarm number 1 of CH04	0: Alarm OFF, 1: Alarm ON
13	Alarm number 2 of CH04	0: Alarm OFF, 1: Alarm ON
14	Alarm number 3 of CH04	0: Alarm OFF, 1: Alarm ON
15	Alarm number 4 of CH04	0: Alarm OFF, 1: Alarm ON

*8 The control data alarm statuses of registers D7614 and D7615 indicate the statuses of alarm numbers 1 to 4 of each loop using the bit status of the register (16 bits). If the status of alarm numbers 1 to 4 of each loop is ON, the corresponding bit is set to 1 regardless of the alarm type. When the data is read using ladder communications, the 16-bit signed data converted to BCD is returned. Therefore, the host computer must convert the value to 16-bit signed integer. If registers D7614 and D7615 are read on a 0-loop model or if register D7615 is read on a two-loop model or four-loop model (or when four loops are selected in the "Basic setting" on a six-loop model), "0" is returned.

Bit Configuration of Register D7614 (for loops 1 to 4)

Bit	Corresponding Alarm	Bit Status and Alarm Status
0	Alarm number 1 of loop 1	0: Alarm OFF, 1: Alarm ON
1	Alarm number 2 of loop 1	0: Alarm OFF, 1: Alarm ON
2	Alarm number 3 of loop 1	0: Alarm OFF, 1: Alarm ON
3	Alarm number 4 of loop 1	0: Alarm OFF, 1: Alarm ON
4	Alarm number 1 of loop 2	0: Alarm OFF, 1: Alarm ON
5	Alarm number 2 of loop 2	0: Alarm OFF, 1: Alarm ON
6	Alarm number 3 of loop 2	0: Alarm OFF, 1: Alarm ON
7	Alarm number 4 of loop 2	0: Alarm OFF, 1: Alarm ON
8	Alarm number 1 of loop 3	0: Alarm OFF, 1: Alarm ON
9	Alarm number 2 of loop 3	0: Alarm OFF, 1: Alarm ON
10	Alarm number 3 of loop 3	0: Alarm OFF, 1: Alarm ON
11	Alarm number 4 of loop 3	0: Alarm OFF, 1: Alarm ON
12	Alarm number 1 of loop 4	0: Alarm OFF, 1: Alarm ON
13	Alarm number 2 of loop 4	0: Alarm OFF, 1: Alarm ON
14	Alarm number 3 of loop 4	0: Alarm OFF, 1: Alarm ON
15	Alarm number 4 of loop 4	0: Alarm OFF, 1: Alarm ON

Bit Configuration of Register D7615 (for loops 5 and 6)

Bit	Corresponding Alarm	Bit Status and Alarm Status
0	Alarm number 5 of loop 1	0: Alarm OFF, 1: Alarm ON
1	Alarm number 5 of loop 2	0: Alarm OFF, 1: Alarm ON
2	Alarm number 5 of loop 3	0: Alarm OFF, 1: Alarm ON
3	Alarm number 5 of loop 4	0: Alarm OFF, 1: Alarm ON
4	Alarm number 6 of loop 1	0: Alarm OFF, 1: Alarm ON
5	Alarm number 6 of loop 2	0: Alarm OFF, 1: Alarm ON
6	Alarm number 6 of loop 3	0: Alarm OFF, 1: Alarm ON
7	Alarm number 6 of loop 4	0: Alarm OFF, 1: Alarm ON
8	–	0
9	–	0
10	–	0
11	–	0
12	–	0
13	–	0
14	–	0
15	–	0

Note

- If data of a register related to an uninstalled loop is read, a "0" is returned.
- If the data of a register assigned to auto/manual/cascade switching, run/stop switching, or remote/local switching is read immediately after the CX powers up or immediately after reverting from the basic setting mode, "D1" may be returned.

Appendix 6 Register Assignments

*9 Registers D7801–D7803 (status of control module DI), 37004 (status of expansion module DI), D7811–D7813 (status of control module DO), D7814 (status of expansion module DIO), and D7821–D7823 (status of internal switches) show the status of each bit in the register (16-bit). The status of the DIO and internal switches are shown in order from the last bit in the register.

Bit Configuration of Register D7801

Bit	Bit and DI status
0	DI001(0: OFF, 1: ON)
1	DI002(0: OFF, 1: ON)
2	DI003(0: OFF, 1: ON)
3	DI004(0: OFF, 1: ON)
4	DI005(0: OFF, 1: ON)
5	DI006(0: OFF, 1: ON)
6-15	Unused

Bit Configuration of Register D7814

Bit	Bit and DO of expanded DIO module status
0	RO001(0: OFF, 1: ON)
1	RO002(0: OFF, 1: ON)
2	RO003(0: OFF, 1: ON)
3	RO004(0: OFF, 1: ON)
4	RO005(0: OFF, 1: ON)
5	RO006(0: OFF, 1: ON)
6	RO007(0: OFF, 1: ON)
7	RO008(0: OFF, 1: ON)
8	RO009(0: OFF, 1: ON)
9	RO010(0: OFF, 1: ON)
10	RO011(0: OFF, 1: ON)
11	RO012(0: OFF, 1: ON)
12-15	Unused

Bit Configuration of Register D7821

Bit	Bit and internal switch status
0	SW001(0: OFF, 1: ON)
1	SW002(0: OFF, 1: ON)
2	SW003(0: OFF, 1: ON)
3	SW004(0: OFF, 1: ON)
4	SW005(0: OFF, 1: ON)
5	SW006(0: OFF, 1: ON)
6	SW007(0: OFF, 1: ON)
7	SW008(0: OFF, 1: ON)
8	SW009(0: OFF, 1: ON)
9	SW010(0: OFF, 1: ON)
10	SW011(0: OFF, 1: ON)
11	SW012(0: OFF, 1: ON)
12	SW013(0: OFF, 1: ON)
13	SW014(0: OFF, 1: ON)
14	SW015(0: OFF, 1: ON)
15	SW016(0: OFF, 1: ON)

Bit Configuration of Register D7823

Bit	Bit and internal switch status
0	SW033(0: OFF, 1: ON)
1	SW034(0: OFF, 1: ON)
2	SW035(0: OFF, 1: ON)
3	SW036(0: OFF, 1: ON)
4-15	Unused

Appendix 7 Messages

Messages related mainly to the communications of the CX and their corrective actions are given. Error responses to communication commands are output in English.

For a description of the messages not covered in this section, see the *user's manual* IM 04L31A01-01E or IM 04L31A01-03E.

Errors Related to Parameter Settings

• Setting Errors

Code	Message	Explanation/Countermeasures/Ref. section
8	Incorrect input mode.	Sections 6.4 and 6.5
9	Incorrect input range code.	Sections 6.4 and 6.5
10	A disabled loop number is selected.	Sections 6.4, 6.8, and 6.9
11	A disabled module number is selected.	Section 6.8
12	A disabled input kind is selected.	Sections 6.4 and 6.5
13	A disabled pid number is selected.	Sections 6.4 and 6.8
14	A disabled segment number is selected.	Section 6.4
21	Cannot set an alarm for a skipped channel.	Section 6.5
31	Partial-expansion display is set ON for a SKIPPED channel.	Section 6.5
41	There is no specified input channel.	Sections 6.5, 6.7, and 6.11
42	Exceeded the number of channels which can be set.	Sections 6.5, 6.7, and 6.11
93	String including space or all space cannot be specified.	Spaces are not allowed in the Web browser user name and password.
94	More than one address cannot be specified.	Only a single sender is allowed.
100	IP address doesn't belong to class A, B, or C.	Section 6.7
101	The result of the masked IP address is all 0s or 1s.	Section 6.7
102	SUBNET mask is incorrect.	Section 6.7
103	The net part of default gateway is not equal to that of IP address.	Section 6.7
104	FTP client failed because the memory mode is 'manual'.	Section 6.7

• Execution Errors

Code	Message	Explanation/Countermeasures/Ref. section
160	Cannot load the specified data. Change the memory setting.	Sections 2.3, 3.5, and 4.2
165	Auto setting is not possible because the target is not support.	Use manual setting instead of auto setting. Sections 9.4 to 9.6
166	This action is not possible because communication protocol is not "Modbus-M."	Chapter 4

Operation Errors

• Errors Related to the External Storage Medium

Code	Message	Explanation/Countermeasures/Ref. section
200	Operation aborted because an error was found in media.	Check the external storage medium.
214	There is no file or directory.	Section 6.11

• Errors Related to E-mail and Web Server

Code	Message	Explanation/Countermeasures/Ref. section
260	IP address is not set or ethernet function is not available.	The IP address is not specified. Check the IP address.
261	SMTP server is not found.	Occurs when the SMTP server is specified by name. <ul style="list-style-type: none"> • Check the DNS setting. • Check the SMTP server name.
262	Cannot initiate E-mail transmission.	<ul style="list-style-type: none"> • The host name of the CX is not correct. Check the host name. • The port number of the SMTP server is not correct. Check the port number.
263	Sender's address rejected by the server.	Check the sender's address.
264	Some recipients' addresses are invalid.	Check the recipient's address.
265	SMTP protocol error.	May occur if a network failure (cable problems, duplicate addresses, network device failure, and so on) occurs in the middle of the e-mail transmission.
266	Ethernet cable is not connected.	Check the cable connection.
267	Could not connect to SMTP server.	<ul style="list-style-type: none"> • Check to see that the SMTP server is connected to the network. • If the SMTP server name is specified using an IP address, check to see that the IP address is correct.
268	E-mail transmission request failed.	Contact your nearest YOKOGAWA dealer.
269	E-mail transfer error.	May occur if a network failure (cable problems, duplicate addresses, network device failure, and so on) occurs in the middle of the e-mail transmission.
275	The current image cannot be output to the Web.	The setup display cannot be output to the Web browser. This message is displayed on the Web browser.
276	Image data currently being created. Unable to perform key operation. This message is displayed on the Web browser.	Try again a little later.
277	Could not output screen to Web.	Failed to create the image. This message is displayed on the Web browser.

• Errors Related to FTP Client

The detail code does not appear in the error message on the screen. You can view the code on the FTP log display of the CX or using the FTP log output via communications.

Code	Message
280	<p>IP address is not set or FTP function is not available. Further details are provided by the character string that appears after error code 280.</p> <hr/> <p>Character String and Details</p> <hr/> <p>HOSTADDR The IP address of the CX has not been specified. Check the IP address.</p> <p>DORMANT Internal processing error.*1</p> <p>LINK Data link is disconnected. Check the cable connection.</p>
281	<p>FTP mail box operation error. Further details are provided by the character string that appears after error code 281.</p> <hr/> <p>Character String and Details</p> <hr/> <p>MAIL Internal processing error.*1</p> <p>STATUS Internal processing error.*1</p> <p>TIMEOUT Internal processing error.*1</p> <p>PRIORITY Internal processing error.*1</p> <p>NVRAM Internal processing error.*1</p>
282	<p>FTP control connection error. Further details are provided by the character string that appears after error code 282.</p> <hr/> <p>Character String and Details</p> <hr/> <p>HOSTNAME Failed the DNS lookup (search the IP address corresponding to the host name). Check the DNS setting and the destination host name.*1</p> <p>TCPIP Internal processing error.*1</p> <p>UNREACH Failed to connect to a control connection server. Check the address setting and that the server is running.</p> <p>OOBINLINE Internal processing error.*1</p> <p>NAME Internal processing error.*1</p> <p>CTRL The control connection does not exist. Check that the server does not drop the connection and that it responds within the proper time period.</p> <p>IAC Failed to respond in the TELNET sequence. Check that the server does not drop the connection and that it responds within the proper time period.</p> <p>ECHO Failed to transmit data on the control connection. Check that the server does not drop the connection and that it responds within the proper time period.</p> <p>REPLY Failed to receive data on the control connection. Check that the server does not drop the connection and that it responds within the proper time period.</p>

Appendix 7 Messages

Code	Message
------	---------

	<hr/> Character String and Details <hr/>
--	---

	SERVER
--	---------------

	The server is not in a condition to provide the service.
--	--

	Check that the server is in a condition in which service can be provided.
--	---

283	FTP command was not accepted.
-----	-------------------------------

	Further details are provided by the character string that appears after error code 283.
--	---

	<hr/> Character String and Details <hr/>
--	---

	USER
--	-------------

	Failed user name verification.
--	--------------------------------

	Check the user name setting.
--	------------------------------

	PASS
--	-------------

	Failed password verification
--	------------------------------

	Check the password setting.
--	-----------------------------

	ACCT
--	-------------

	Failed account verification.
--	------------------------------

	Check the account setting.
--	----------------------------

	TYPE
--	-------------

	Failed to change the transfer type.
--	-------------------------------------

	Check that the server supports the binary transfer mode.
--	--

	CWD
--	------------

	Failed to change the directory.
--	---------------------------------

	Check the initial path setting.
--	---------------------------------

	PORT
--	-------------

	Failed to set the transfer connection.
--	--

	Check that the security function is disabled.
--	---

	PASV
--	-------------

	Failed to set the transfer connection.
--	--

	Check that the server supports PASV commands.
--	---

	SCAN
--	-------------

	Failed to read the transfer connection settings.
--	--

	Check that proper response to the PASV command is received from the server.
--	---

284	FTP transfer setting error.
-----	-----------------------------

	Further details are provided by the character string that appears after error code 284.
--	---

	<hr/> Character String and Details <hr/>
--	---

	MODE
--	-------------

	Internal processing error.*1
--	------------------------------

	LOCAL
--	--------------

	Internal processing error.*1
--	------------------------------

	REMOTE
--	---------------

	The destination file name is not correct.
--	---

	Check that you have permission to create or overwrite files.
--	--

	ABORT
--	--------------

	File transfer abort was requested by the server.
--	--

	Check the server for the reason for the abort request.
--	--

Code Message

285 FTP data connection error.

Further details are provided by the character string that appears after error code 285.

Character String and Details

SOCKET

Failed to create a socket for the transfer connection.*2

BIND

Failed the transfer connection command.*2

CONNECT

Failed the transfer connection.*2

LISTEN

Failed the transfer connection reception.*2

ACCEPT

Failed to accept the transfer connection.*2

SOCKNAME

Internal processing error.*2

RCV

Failed to receive data over the transfer connection.*2

SEND

Failed to send data over the transfer connection.*2

286 FTP file transfer error.

Further details are provided by the character string that appears after error code 286.

Character String and Details

READ

Internal processing error.*1

WRITE

Internal processing error.*1

*1 Contact your nearest YOKOGAWA dealer.

*2 These errors may occur if the network experiences trouble during the data transmission (bad cable connection, duplicate addresses, network equipment failure).

Note

- The FTP client function on the CX has a timer function that drops the connection if there is no data transfer for two minutes. If the server does not respond within this time period, the transfer fails.
 - If the FTP client function on the CX detects a file with the same name at the destination, the file is transferred with the last character (8th character) of the file name changed.
-

Communication Errors

- **Errors during Setting and Basic Setting Modes, Output Communication Command Execution, and Setup Data Loading**

Code	Message
300	Command is too long.
301	Too many number of commands delimited with ';'.
302	This command has not been defined.
303	Data request command can not be enumerated with sub-delimiter.
350	Command is not permitted to the current user level.
351	This command cannot be specified in the current mode.
352	The option is not installed.
353	This command cannot be specified in the current setting.
354	This command is not available during sampling, calculating or controlling.
357	The setup output command cannot be executed in this condition.

- **Memory Access Errors during Setting and Basic Setting Modes and Output Communication Command Execution**

An English error message is returned via the communication interface. It is not displayed on the screen.

Code	Message
360	Output interface must be chosen from Ethernet or RS by using 'XO' command.
361	The memory data is not saved for the communication output.
362	There are no data to send 'NEXT' or 'RESEND'.
363	All data have already been transferred.
370	Command is not permitted to the current model.

- **Maintenance and Test Communication Command Errors**

An English error message is returned via the communication interface. It is not displayed on the screen.

Code	Message
390	Command error.
391	Delimiter error.
392	Parameter error.
393	No permission.
394	No such connection.
395	Use 'quit' to close this connection.
396	Failed to disconnect.
397	No TCP control block.

• Other Communication Errors

An English error message is returned via the communication interface. It is not displayed on the screen.

Code	Message
400	Input username.
401	Input password.
402	Select username from 'admin' or 'user'.
403	Login incorrect, try again!
404	No more login at the specified level is acceptable.
410	Login successful. (The special user level)
411	Login successful. (The general user level)
420	Connection has been lost.
421	The number of simultaneous connection has been exceeded.
422	Communication has timed-out.

• Status Messages

Code	Message
512	Because memory save is 'manual' mode, FTP is not available.
520	Connecting to the line...
521	The data file is being transferred.
530	Setting data cannot be saved during output of setting data.
551	FTP test is being executed...
564	Program parameter cannot be changed during FE4 executing.
566	The specified data cannot be loaded during FE4 executing.
568	The specified data cannot be loaded during program operation.

• Errors Related to Control Operation

Code	Message	Explanation/Countermeasures/Ref. section
724	Can not operate in the present situation.	–
725	Modbus Communication Error.	Check the wiring or communication settings. Chapters 3 and 4.
726	The specified target is not assigned to the control group.	Specify another loop.

Appendix 8 Login Procedure

You log into the CX from your PC to use the functionality of the setting/measurement server and the maintenance/test server via the Ethernet interface. If you complete the procedure successfully up to login complete in the following figure, the commands in chapter 6 become functional.

When Using the Ethernet Login Function of the CX

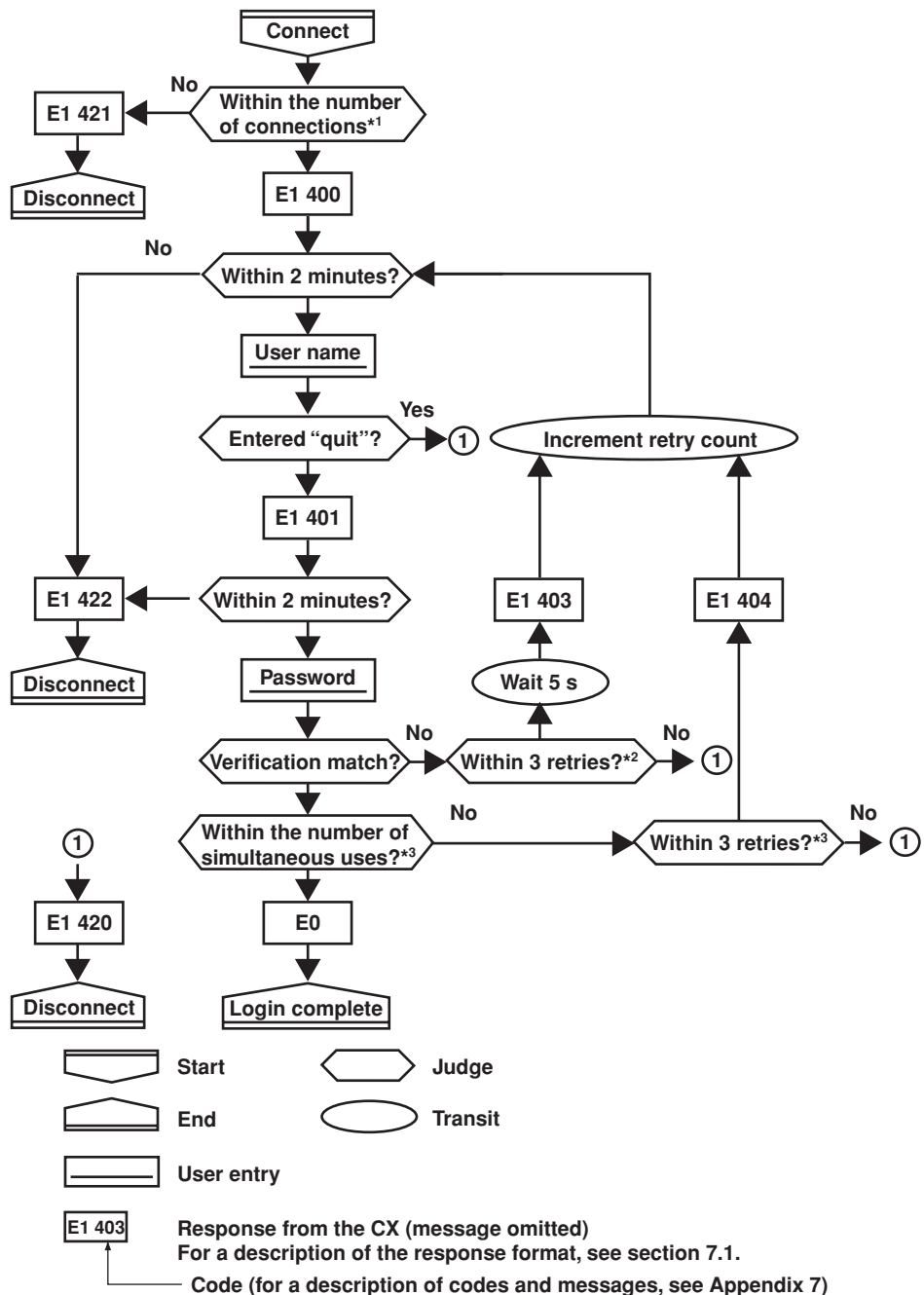

*1 Connections cannot exceed the maximum number of connections (see section 2.1).

*2 If you try to log in using a wrong password four consecutive times, the communication is dropped (the number of retries for login is three).

*3 If you try to log in causing the number of simultaneous uses at the administrator or user level to be exceeded (see section 2.1) four consecutive times, the communication is dropped (even if the password is correct).

When Not Using the Login Function of the CX

Login as "admin" or "user."

- The user name "admin" can be used to login to the CX as an administrator.
- The user name "user" can be used to access the CX as a user.

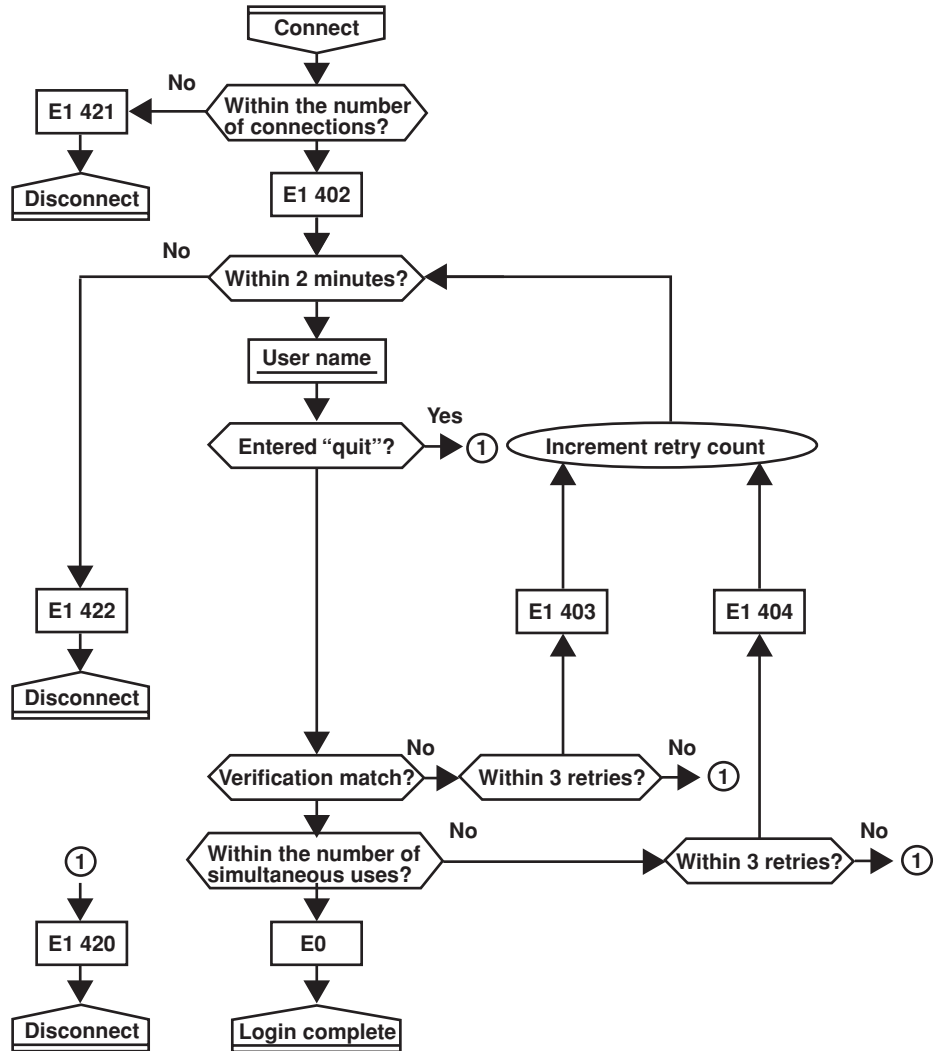

Index

A

account	2-11
address	3-10, 4-6
ADMINISTRATOR	2-17
affirmative response	7-1
alarm indication	9-25
alarm summary	7-21
alarm type	9-9, 9-25
ASCII character codes	App-1
ASCII output	7-2
auto reading	9-7
auto setting	9-14, 9-17

B

basic setting	9-6
basic setting commands (control)	6-9, 6-49
basic setting commands (measurement)	6-8, 6-40
basic setting data	7-7
baud rate	3-10, 4-2, 5-2
BINARY output	7-2
bit structure	3-9
bit structure of the status information	8-2
block	7-30
block member	7-27
broadcast request	4-14

C

calculating the sum value	7-4
checking the condition of the connection	1-8
Command	
AD	6-54
AK	6-37
AP	6-23
AT	6-17
AV	6-17
BD	6-35
BO	6-55
CA	6-54
CC	6-55
close	6-61
CM	6-39
con	6-61
CR	6-15
CS	6-55
DS	6-38
EM	6-39
EO	6-22
EP	6-22
ESC C	6-59
ESC O	6-59
ET	6-21

eth	6-62
EV	6-37
FC	6-55
FD	6-56
FE	6-55
FF	6-56
FG	6-19
FH	6-59
FJ	6-60
FK	6-60
FL	6-56
FM	6-59
FP	6-59
FR	6-35
FU	6-57
FV	6-61
GA	6-23
GB	6-49
GC	6-18
GD	6-18
GE	6-51
GF	6-51
GG	6-19
GH	6-53
GI	6-49
GJ	6-52
GK	6-52
GL	6-23
GM	6-49
GO	6-18
GQ	6-53
GR	6-51
GS	6-51
GT	6-50
GU	6-52
GV	6-52
GW	6-53
HA	6-20
HB	6-49
HD	6-19
HE	6-20
help	6-62
HF	6-23
HG	6-51
HH	6-18
HI	6-18
HL	6-18
HM	6-18
HO	6-19
HP	6-18

Index

HQ	6-49	SH	6-31
HR	6-50	SI	6-34
HS	6-17	SJ	6-34
HT	6-17	SK	6-33
HU	6-54	SL	6-31
HV	6-54	SN	6-54
HW	6-18	SP	6-30
HX	6-49	SQ	6-32
HY	6-51	SR	6-27
IF	6-55	SS	6-34
IS	6-57	ST	6-31
LI	6-39	SU	6-33
LO	6-38	SV	6-32
MB	6-16	SW	6-30
ME	6-57	SX	6-31
MF	6-17	SY	6-33
MI	6-58	SZ	6-30
MO	6-58	TL	6-38
MS	6-38	UD	6-36
net	6-62	XA	6-40
OC	6-54	XB	6-40
OS	6-54	XE	6-44
PA	6-22	XG	6-44
PB	6-20	XH	6-44
PC	6-49	XI	6-40
PD	6-21	XJ	6-40
PE	6-22	XM	6-41
PG	6-21	XO	6-44
PH	6-23	XP	6-44
PJ	6-21	XQ	6-42
PM	6-21	XR	6-42
PN	6-54	XS	6-41
PO	6-21	XT	6-41
PP	6-49	XU	6-41
PQ	6-21	XV	6-41
PR	6-22	YA	6-45
PS	6-37	YC	6-46
PT	6-21	YG	6-46
PU	6-21	YK	6-45
PW	6-21	YL	6-46
PX	6-54	YM	6-46
PY	6-49	YN	6-45
PZ	6-21	YO	6-46
quit	6-62	YQ	6-45
RL	6-54	YS	6-45
RM	6-43	YT	6-46
RO	6-42	YU	6-47
RS	6-17	YV	6-48
SA	6-29	YW	6-48
SB	6-32	YX	6-48
SC	6-32	command construction	5-5
SD	6-30	command name	6-1
SE	6-31	command syntax	6-1
SF	6-32	communication address	5-2
SG	6-31	communication errors	App-54

communication input data	4-6
communication log	1-8, 7-15
communication log screen	2-22
communication program for FA-M3	5-8
communication program for MELSEC	5-13
communication status	4-11, 9-22
communication with PCs	1-13
communications with PLCs	5-5
conceptual diagram	7-2
condition register	8-1
configuring of the ethernet interface	2-3
connectable loops	9-1
connecting model	9-1, 9-6
connection procedure	3-2
connection status	2-9
control commands	6-10, 6-54
control mode	9-8
control operation	9-25
control output type	9-9
control span	9-7
control status	9-25
conventions used in this manual	vi
CPU number	5-5

D

D register number	5-5
DAQSTANDARD software	1-7
data dropout	4-11, 9-22, App-8
data length	3-10
data list	7-24
decimal point position	7-8
default gateway	2-3
delimiter	6-2
display data	7-28
displaying error log	1-8
DNS	2-3
domain name	2-3
domain suffix	2-4

E

e-mail log	1-8, 7-20
e-mail log screen	2-23
e-mail message	2-48
e-mail transmission	1-2
e-mail transmission function	2-38
e-mail transmission test	2-47
error log screen	2-22
error messages	9-26
ethernet communication function	1-2
ethernet interface connection	2-9
Ethernet interface specifications	2-1
event data	7-30
execution errors	App-49
external loop setting	9-2, 9-6
EXTLOOP STATUS display	9-22

F

FIFO buffer	App-6
FIFO data	7-26
file list	7-23
filter	8-1
flag	7-3, 7-27
four-wire system	3-6
front panel	vii
FTP client	1-4, 2-10
FTP destination	2-10
FTP log	1-8, 7-17
FTP log screen	2-22
FTP server	1-5
FTP server name	2-10
FTP test	2-16
function code	4-14

G

green series communication function	9-1
green series communications	1-9

H

handshaking	3-3
handshaking method	3-10
header	7-30
hold registers	App-9, App-19, App-20, App-22, App-24, App-25, App-29, App-39, App-40, App-42, App-44, App-45
host name	2-3

I

I/O assignment switch setting	5-13
I/O assignments	5-13
identifier	7-3
initial path	2-11
input range parameter	6-13
input registers	App-25
instrument information output commands	6-12, 6-63
instrument information server	1-6
internal memory	3-10, 4-2
IP address	2-3
item ID	9-18
item name	9-18

K

keep alive	1-8, 2-18
key login log	7-18

Index

L

ladder communication module 5-8
ladder communication protocol 5-1
ladder communications 1-12
limitations 9-3
list of commands 6-4
login and timeout functions 2-17
login function App-56, App-57
login name 2-11
login procedure App-56
loop number 9-6, 9-14, 9-17
loopback test 4-15

M

maintenance/test commands 6-12, 6-61
maintenance/test server 1-6
manual sampled data 7-30
master function 4-1
measured/computed/control data 7-9, 7-26
MELSEC 5-13
message format for errors 4-16
message summary 7-22
messages App-49
modbus address 9-6
Modbus master 1-10
modbus protocol 4-2
modbus protocol specifications 4-1
Modbus slave 1-11
modbus slave 4-13
monitor page 2-26, 2-31
multiple negative responses 7-1

N

number of blocks 7-26, 7-31, 7-32, 7-35
number of bytes 7-26, 7-31, 7-32, 7-35, 7-36, 7-37

O

operation error log 7-18
operation errors App-50
operation mode 9-24
operation status of the modbus master 4-11
operator page 2-26, 2-34
output commands 6-10, 6-11, 6-55, 6-59
output commands (control) 6-55
output example 7-39
output flow of FIFO data App-6
output flow of internal memory data App-2
output flow of the file App-4
output format of ASCII data 7-6
output format of BINARY data 7-26
output format of instrument information 7-39
overview of the communication functions 1-1

P

page type 2-26
parameter address setting 9-14
parameters 6-1
parity check 3-10, 4-2, 5-2
password 2-11, 2-17
PASV mode 2-11
pin arrangement 3-2
port number 2-11
program control display 9-25
program example 5-8, 5-14
protocol 3-10, 5-2

Q

query 6-2

R

read cycle 4-5
read multiple hold registers 4-14
read multiple input registers 4-14
read-only parameters App-45
rear panel viii
receive buffer 3-9
register addresses 9-14
register assignments App-9
register assignments (Ladder Comm.) App-29
register assignments during MODBUS slave App-9
register number 4-13
registers 4-6
registers address 9-18
report data 7-30
response error codes 4-16
response syntax 7-1
retrial 4-5, 4-11, 9-22
revisions ii
RS-232 specifications 3-1
RS-422/485 dedicated commands and responses 7-5
RS-422/485 specifications 3-1
RTU mode 9-1

S

safety precautions iii
safety symbols iii
serial communication function 1-9
serial interface converter 3-8
serial interface specifications 3-1
setting commands (control) 6-4, 6-15
setting commands (measurement) 6-6, 6-27
setting commands (operation) 6-36
setting data 7-7
setting errors App-49
setting/measurement server 1-6

setup procedure using operation keys	ix
signal names	3-2, 3-5
simultaneous connections	2-1
simultaneous users	2-1
single negative response	7-1
slave address	4-2, 4-13
slave function	4-1
special data values	7-27, 7-30
station number	5-5
status information	7-22, 8-1
status lamp	4-11, 9-22
structure of the manual	v
sub delimiter	6-2
subnet mask	2-3

T

tag	9-6
tag comment	9-6
terminal arrangement	3-5
terminator	3-8, 6-2
time out	2-18
timeout time	4-5
trademarks	ii
transferred files	2-10
tuning display	9-25
tuning setting	9-17
turning Off/On communications	9-6
turning parameters	9-18
two-wire system	3-7
type	4-6

U

unit information	7-8
USER	2-17
user control	1-8
user level	2-17, 7-25
user name	2-17

W

web browser operation log screen	2-23
web operation log	1-8, 7-19
web server	1-3
web server function	2-26
writable and readable parameters	App-29
write to multiple hold registers	4-15
write to single hHold register	4-15